

Series SD

User's Manual



Limit Controller



1241 Bundy Boulevard., Winona, Minnesota USA 55987
Phone: +1 (507) 454-5300, Fax: +1 (507) 452-4507 <http://www.watlow.com>



Safety Information

We use note, caution and warning symbols throughout this book to draw your attention to important operational and safety information.

A “NOTE” marks a short message to alert you to an important detail.

A “CAUTION” safety alert appears with information that is important for protecting your equipment and performance. Be especially careful to read and follow all cautions that apply to your application.

A “WARNING” safety alert appears with information that is important for protecting you, others and equipment from damage. Pay very close attention to all warnings that apply to your application.

The safety alert symbol, ⚠ (an exclamation point in a triangle) precedes a general CAUTION or WARNING statement.

The electrical hazard symbol, ⚡ (a lightning bolt in a triangle) precedes an electric shock hazard CAUTION or WARNING safety statement.

Technical Assistance

If you encounter a problem with your Watlow controller, review your configuration information to verify that your selections are consistent with your application: inputs, outputs, alarms, limits, etc. If the problem persists after checking the configuration of the controller, you can get technical assistance from your local Watlow representative (see back cover), or by dialing +1 (507) 494-5656 between 7 a.m. and 5 p.m., Central Standard Time (CST). Ask for an Applications Engineer. Please have the following information available when calling:

- Complete model number
- All configuration information
- User’s Manual
- Factory Page

Warranty

The series SD is manufactured by ISO 9001-registered processes and is backed by a three-year warranty.

Return Material Authorization (RMA)

1. Call Watlow Customer Service, (507) 454-5300, for a Return Material Authorization (RMA) number before returning any item for repair. If you do not know why the product failed, contact an Application Engineer or Product Manager. All RMA’s require:
 - Ship to address
 - Contact name
 - Method of return shipment
 - Detailed description of the problem
 - Name and phone number of person returning the product.
 - Bill to address
 - Phone number
 - Your P.O. number
 - Any special instructions
2. Prior approval and an RMA number from the Customer Service Department is required when returning any product for credit, repair or evaluation. Make sure the RMA number is on the outside of the carton and on all paperwork returned. Ship on a Freight Prepaid basis.
3. After we receive your return, we will examine it and try to verify the reason for returning it.
4. In cases of manufacturing defect, we will enter a repair order, replacement order or issue credit for material returned. In cases of customer mis-use, we will provide repair costs and request a purchase order to proceed with the repair work.
5. To return products that are not defective, goods must be in new condition, in the original boxes and they must be returned within 120 days of receipt. A 20 percent restocking charge is applied for all returned stock controls and accessories.
6. If the unit is unrepairable, you will receive a letter of explanation. and be given the option to have the unit returned to you at your expense or to have us scrap the unit.
7. Watlow reserves the right to charge for no trouble found (NTF) returns.

The Series SD User’s Manual is copyrighted by Watlow Winona, Inc., © November 2004 with all rights reserved.



**CAUTION or
WARNING**



**Electrical
Shock Hazard**

CAUTION or WARNING

Table of Contents

- Chapter 1: Overview**2
- Chapter 2: Install and Wire**4
 - Dimensions4
 - Installation6
 - Wiring11
- Chapter 3: Keys and Displays**19
 - Home Page Overview20
 - Operations Page Overview20
 - Setup Page Overview21
 - Programming Page Overview22
 - Factory Page Overview22
- Chapter 4: Home Page**23
- Chapter 5: Setup Page**24
- Chapter 6: Operations Parameters Table**30
- Chapter 7: Programming Page**32
- Chapter 8: Factory Page and Calibration**34
- Chapter 9: Features**39
 - Saving and Restoring User Settings40
 - Operations Page40
 - Inputs40
 - Limits42
 - Alarms42
 - Retransmit43
 - Communications43
 - Troubleshooting46
 - Error Messages48
- Appendix**49
 - Specifications49
 - Ordering Information51
 - Index52
 - Declaration of ConformityInside back cover

1

Overview

The Watlow Series SD family of microprocessor-based limit controllers is available in 1/32, 1/16, 1/8 and 1/4 DIN panel mount sizes*. The Series SD limit is added to applications to prevent over or under process conditions. The Series SD limit provides safety assurances against instances where a process runaway condition occurs as a result of a failed sensor or output device.

The Series SD limit is recommended for any application where system runaway could result in large product scrap costs, damage to system equipment, potential fire hazard or risk to personnel. All Series SD limits are Factory Mutual approved.

The Series SD limit has a single, universal input that accepts various thermocouples, RTDs (resistive temperature devices) or process inputs. (See the Specifications in the Appendix for further details).

The Series SD limit offers up to two outputs on the 1/32 DIN, and up to three outputs on all others. Output 1 is always a mechanical relay operating as a latching limit output. Any mechanical relay output can be configured as a latching limit output. These can be configured as a low limit, high limit or low/high limit. Outputs 2 and 3 can be also configured as latching or

non-latching alarms. Standard Series SD limit features include an IP65/NEMA 4X front panel rating; CE compliance; dual, four-digit displays. A low-voltage model is also available.

Advanced features include Modbus, EIA-485 serial communications to interface with PC software applications; INFOSENSE™ technology that provides low-cost, high-accuracy thermal sensing; and infrared remote communication for easy-to-use setup and monitoring.***

Other operator-friendly features include LED indicators to aid in monitoring and setting up the controller. The Watlow Series SD limit automatically stores all information in non-volatile memory and provides an additional back-up for user-selected settings.

For more information on these and all other product features, refer to the Features Chapter and the Appendix.

* Also available in a temperature controller version.

** The 1/32 DIN limit comes only with a red left and green right display.

*** Not available in the 1/32 DIN size.

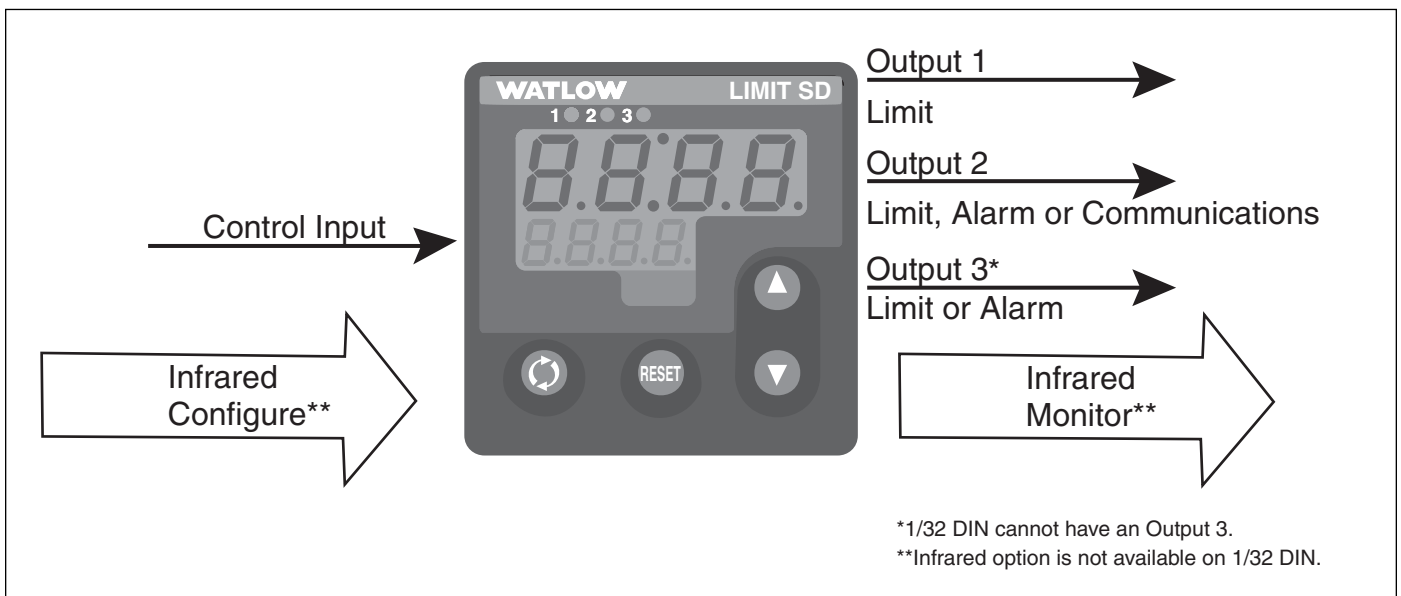

Figure 2 — Series SD limit inputs and outputs.

Features and Benefits

Patented User Definable Menu System

- Simplifies operator interface.

User Defined Default Settings

- Restores user defined controller settings.

INFOSENSE™ Technology

- Improves sensor accuracy by a minimum of 50%.

INFOSENSE™ Technology

- Improves sensor accuracy by a minimum of 50%.

Infrared Communications

- Facilitates controller setup, operation and monitoring.

Up to three outputs (1/32 DIN two outputs only)

- Application versatility.
- Configuration flexibility

Dual Displays on all models

- Better monitoring of process changes.

Also available in an PID temperature controller version.

How to use the Series SD limit

Before you use your Series SD limit, it must be installed and configured correctly. **Which setup steps you need to perform will depend on how you will use it.**

If you purchased the limit to design into your products:

You will need to do the first three steps and maybe some of the fourth step. Some wiring, such as the final wiring of a communications connection or an alarm output for signaling an external device, might be left to the end user. In highly specialized applications with little variation in operation and heat load, the OEM might configure almost all the parameters.

If you purchased the limit to design and install into new equipment for your own use or to retrofit into existing equipment:

You will need to complete all four steps.

If you purchased the limit installed in equipment designed around it:

You will probably only need to do the fourth step. In some instances, you may need to wire it for serial communications and/or an alarm output. Some serial communications parameters in the Setup Page may need to be changed.

Step 1: Mount and install the limit.

The Series SD limit is designed to be panel mounted in a standard DIN opening. The Series SD is available in 1/32 DIN, 1/16 DIN, 1/8 DIN-horizontal, 1/8 DIN-vertical and 1/4 DIN sizes. Cut the correct size hole into the panel and mount the limit, using its mounting brackets. See Chapter Two for details on installation and mounting.

If you retrofit the Series SD limit into an existing application, you may need to modify an existing opening, either by cutting it larger for a larger limit or using a Watlow adapter plate to adapt it to a smaller limit.

Step 2: Wire the limit.

The limit will need to have its power, input and output wiring installed. The wiring depends on the specific model number of the Series SD limit. The dimension illustrations in Chapter Two show the location of the model number on each DIN size. Use the model number to determine which wiring diagrams to follow for your limit. See Chapter Two for wiring details.

Step 3: Configure the Setup Page.

Setup Page parameters tell the limit what input and output devices are wired to the limit and how it should function. Without the proper Setup Page settings, the limit will not operate or could operate erratically. Since these settings require detailed knowledge on the wiring and operation of the equipment, the OEM or the designer normally programs these parameters. Some settings, such as the baud rate or device address, are Setup Page parameters, but would probably be set by the end user.

These settings should be recorded for future reference. The settings can also be stored using the **U5r5** parameter, in the Factory Page. For saving and restoring parameters, see Chapter Eight, Features. For details on configuring the Setup Page, see Chapter Five, Setup Page.

Step 4: Configure the Operations Page.

The Operations Page contains the parameters that the equipment operator may need to set or change from time to time. This includes limit and alarm set points. In some cases the OEM manufacturer may set most of these parameters because the equipment operates with little variation (i.e., always the same limit and alarm set points, always the same heat load). In equipment where demands could vary significantly, the OEM may leave parameter adjustments to the end user (i.e., many different temperature settings, different heat loads).

The Operations Page on the Series SD limit is customizable so that only the parameters that the operator may need to use will appear in the display. Settings that won't need to be adjusted can be hidden from the operator, using the Programing Page. For more details on the Programing Page, see Chapter Eight, Features. For details on configuring parameters in the Operations Page, see Chapter Six, Operations Parameters Tables.

Once you have verified the limit is operating properly, be sure to document all of your parameter settings. Each parameter table has a settings column for you to write in your values.

2

Install and Wire

1/32 DIN Series SD Limit Dimensions

Front

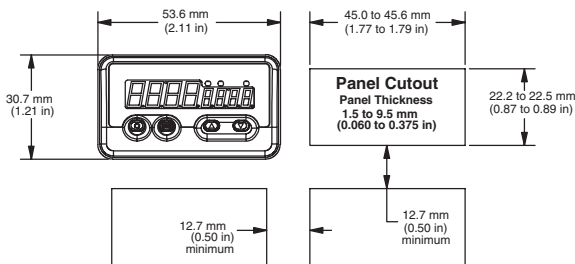

Top

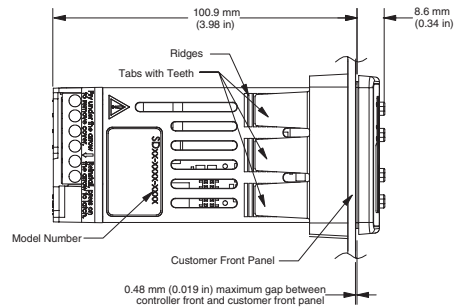

Back

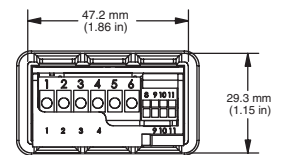

Contact your local Greenlee supplier for the appropriate punch kit and cutout tools required for rapid mounting.

1/16 DIN Series SD Limit Dimensions

Front

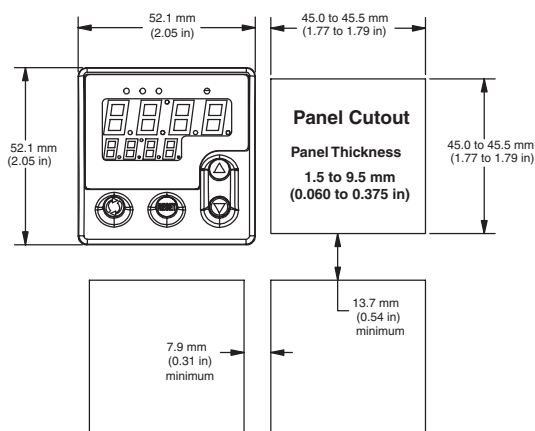

Side

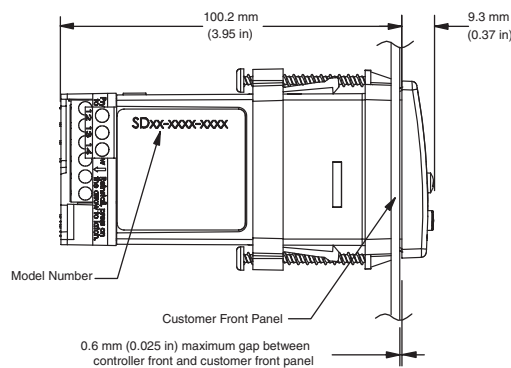

Back

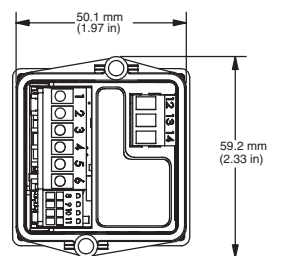

Contact your local Greenlee supplier for the appropriate punch kit and cutout tools required for rapid mounting.

1/8 DIN Series SD Limit Dimensions

Front (horizontal)

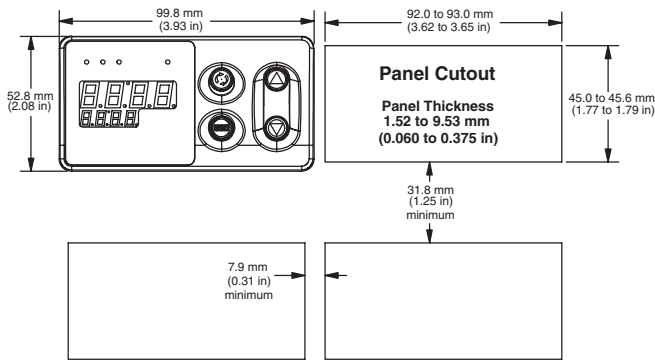

Front (vertical)

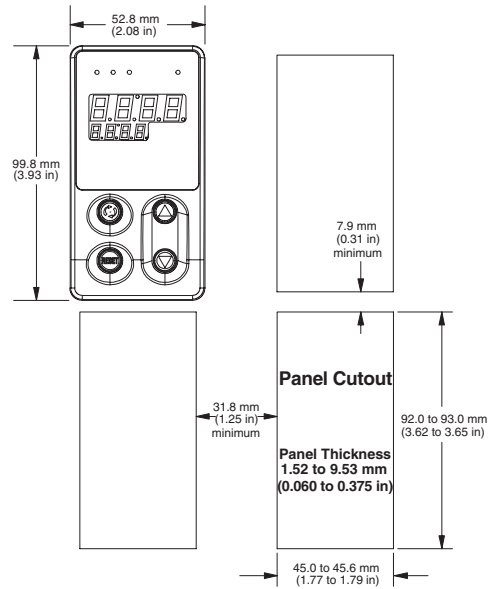

Back (horizontal)

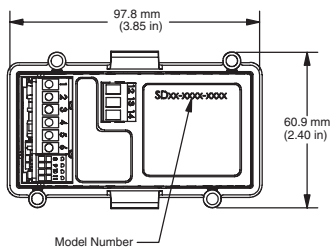

Back (vertical)

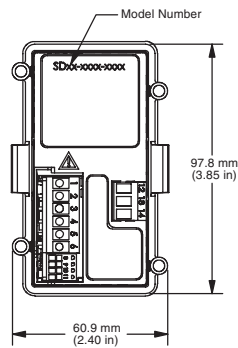

Side (horizontal)

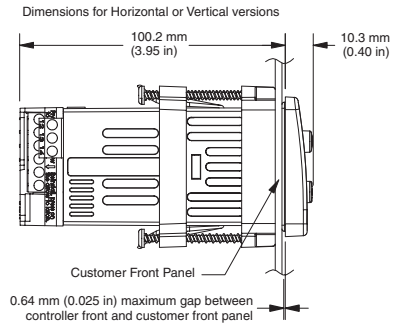

Contact your local Greenlee supplier for the appropriate punch kit and cutout tools required for rapid mounting.

1/4 DIN Series SD Limit Dimensions

Front

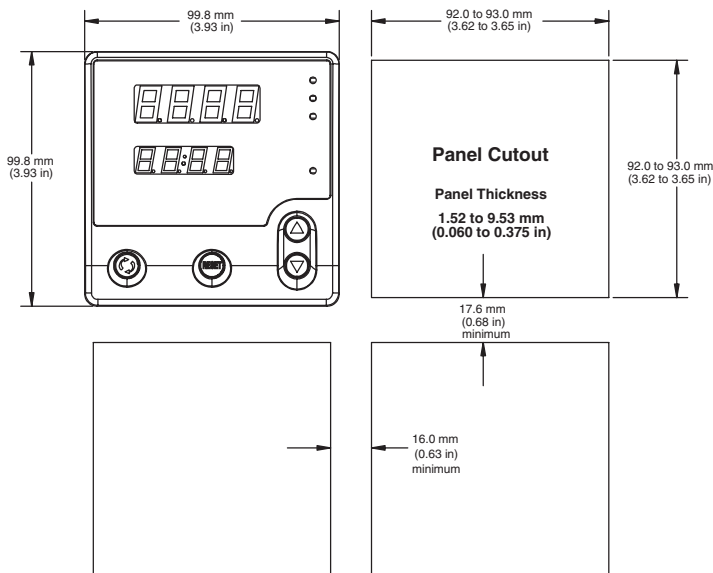

Side

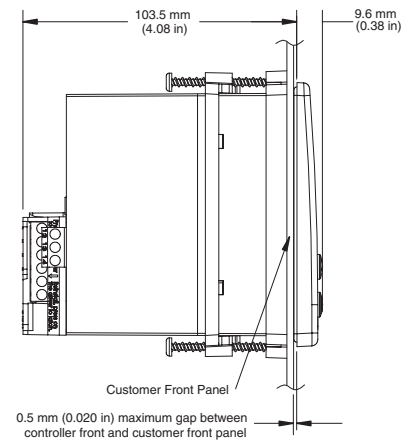

Back

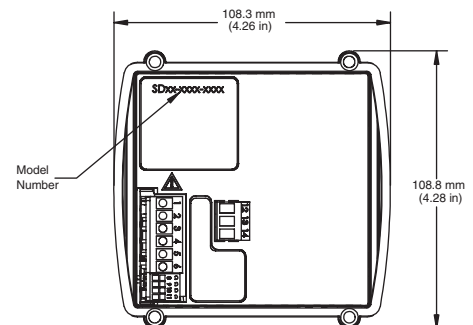

Contact your local Greenlee supplier for the appropriate punch kit and cutout tools required for rapid mounting.



Caution: Follow the installation procedure exactly to guarantee a proper IP65/NEMA 4X seal. Make sure the gasket between the panel and the rim of the case is not twisted and is seated properly. Failure to do so could result in damage to equipment.

Installing and mounting requires access to the back of the panel.

Tools required:
Putty knife or equivalent

Installing the 1/32 DIN Series SD Limit

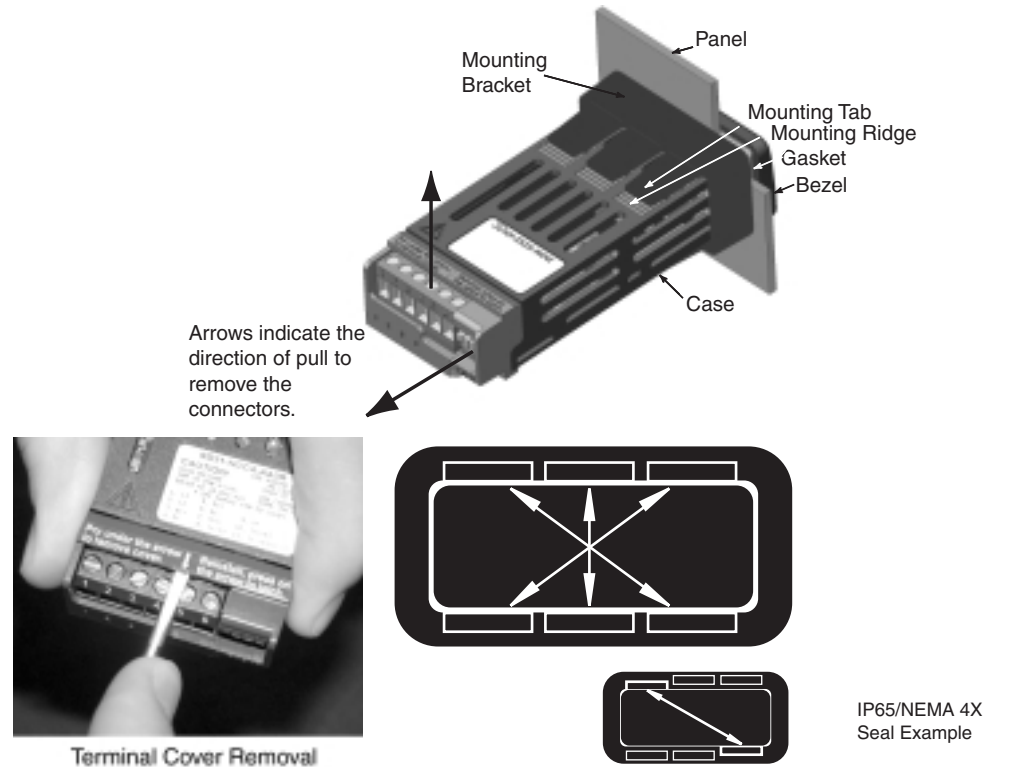

1. Make the panel cutout using the mounting template dimensions in this chapter.
2. Check that the rubber gasket lies in its slot at the back of the bezel. Insert the limit into the panel cutout.
3. While pressing the bezel firmly against the panel, slide the mounting bracket over the back of the limit.
4. If the installation does not require an IP65/NEMA 4X seal, slide the bracket up to the back of the panel enough to eliminate the spacing between the gasket and the panel.

For an IP65/NEMA 4X seal, use your thumb to lock the tabs into place while pressing the limit from side to side. Don't be afraid to apply enough pressure to properly install the limit. If you can move it back and forth in the cutout, you do not have a proper seal. The tabs on each side of the bracket have teeth that latch into the ridges.

Each tooth is staggered at a different depth (from the front) so only one of the tabs on each side is ever locked into the ridges at any time. Either the two middle tabs or the two tabs diagonal from each other will be engaged.

5. If the matching tabs are not engaged, you do not have an IP65/NEMA 4X seal. The space between the bezel and panel must be 0 to 0.48 mm (0 to 0.019 in) maximum.

Removing the 1/32 DIN Series SD Limit

1. Remove the terminal cover and all of the wiring connectors from the back of the limit.
2. Slide a thin, wide tool (putty knife) under all three mounting tabs, top then bottom, while pushing forward on the back of the case. Be ready to support the limit as it slides out of the panel cutout.



Caution: Follow the installation procedure exactly to guarantee a proper IP65/NEMA 4X seal. Make sure the gasket between the panel and the rim of the case is not twisted and is seated properly. Failure to do so could result in damage to equipment.

Note: Be careful not to overtighten the screws. This may cause the mounting bracket to fail. If the front bezel is touching the front panel, the mounting bracket is too tight.

Installing and mounting requires access to the back of the panel.

Tools required:
one #2 Phillips screwdriver

Tools required:
one #2 Phillips screwdriver.

Installing the 1/16 DIN Series SD Limit



Terminal Cover Removal

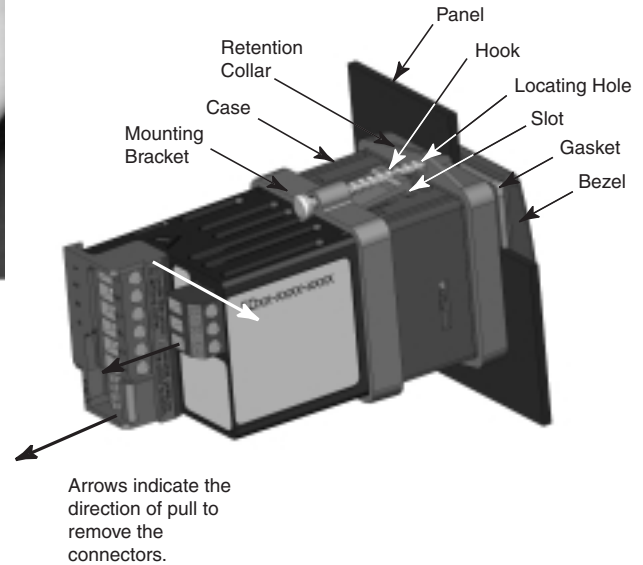

Arrows indicate the direction of pull to remove the connectors.

1. Make the panel cutout using the mounting template dimensions in this chapter.
2. Check that the rubber gasket lies in its slot at the back of the bezel. Insert the limit into the panel cutout. Slide the retention collar over the limit, with the locating holes on the top and bottom, facing the back of the limit.
3. Slide the mounting bracket over the back of the limit with the screw tips pointed toward the panel, aligning with the locating holes in the retention collar. Push it gently but firmly over the limit until the hooks snap into the slots at the front.
4. If the installation does not require an IP65/NEMA 4X seal, tighten the two screws with the Phillips screwdriver just enough to eliminate the spacing between the rubber gasket and the panel.

For an IP65/NEMA 4X seal, tighten the two screws until the gap between the bezel and panel surface is 0.6 mm (0.024 in) maximum. Make sure that you cannot move it back and forth in the cutout. If you can, you do not have a proper seal. Do not over-tighten. Over-tightening could damage the mounting bracket.

Removing the 1/16 DIN Series SD Limit

1. Remove the terminal cover and all of the wiring connectors from the back of the limit. While supporting the limit with one hand, use the Phillips screwdriver to unscrew the two screws on the mounting bracket until the tips are flush or past the end of the hooks.
2. Squeeze the two screws together on the mounting bracket to release the hooks from the slots and slide it off. Remove the retention collar and push the limit out of the panel cutout. Be ready to support the limit as it comes through the front panel.



Caution: Follow the installation procedure exactly to guarantee a proper IP65/NEMA 4X seal. Make sure the gasket between the panel and the rim of the case is not twisted and is seated properly. Failure to do so could result in damage to equipment.

Note: Be careful not to overtighten the screws. This may cause the mounting bracket to fail. If the front bezel is touching the front panel, the mounting bracket is too tight.

Installing and mounting requires access to the back of the panel.

Tools required:
one #2 Phillips screwdriver.

Tools required:
one #2 Phillips screwdriver.

Installing the 1/8 DIN Series SD Limit



Terminal Cover Removal

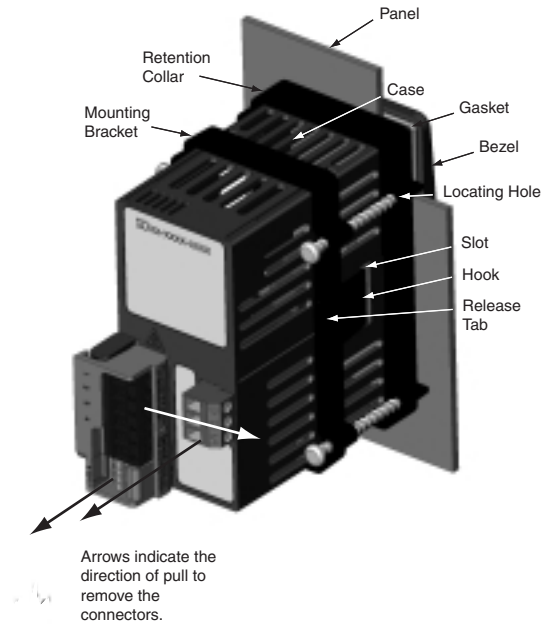

1. Make the panel cutout using the mounting template dimensions in this chapter.
2. Check that the rubber gasket lies in its slot at the back of the bezel. Insert the limit into the panel cutout. Slide the retention collar over the limit, with the locating holes facing the back of the limit.
3. Slide the mounting bracket over the back of the limit with the screw tips pointed toward the panel, aligning with the locating holes in the retention collar. Push it gently but firmly over the limit until the hooks snap into the slots at the front.
4. If the installation does not require an IP65/NEMA 4X seal, tighten the four screws with the Phillips screwdriver just enough to eliminate the spacing between the rubber gasket and the panel.

For an IP65/NEMA 4X seal, tighten the four screws until the gap between the bezel and panel surface is 0.5 mm (0.020 in) maximum. Make sure that you cannot move it back and forth in the cutout. If you can, you do not have a proper seal. Do not over-tighten. Over-tightening could damage the the mounting bracket.

Removing the 1/8 DIN Series SD Limit

1. Remove the terminal cover and all of the wiring connectors from the back of the limit. Using the Phillips screwdriver, unscrew the four screws on the mounting bracket until they disengage from the retention collar.
2. Squeeze the release tabs on the long sides of the mounting bracket and slide the mounting bracket off the back of the Limit. Remove the retention collar and push the limit out of the panel cutout. Be ready to support the limit as it comes through the front panel.



Caution: Follow the installation procedure exactly to guarantee a proper IP65/NEMA 4X seal. Make sure the gasket between the panel and the rim of the case is not twisted and is seated properly. Failure to do so could result in damage to equipment.

Note: Be careful not to overtighten the screws. This may cause the mounting bracket to fail. If the front bezel is touching the front panel, the mounting bracket is too tight.

Installing and mounting requires access to the back of the panel.

Tools required:
one #2 Phillips screwdriver

Tools required:
• one #2 Phillips screwdriver
• one flat-head screwdriver

Installing the 1/4 DIN Series SD Limit



Terminal Cover Removal

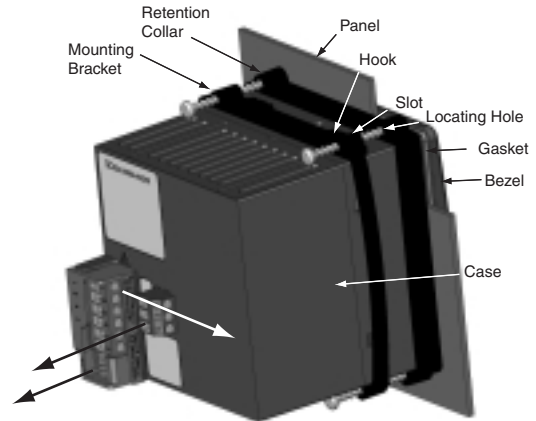

Arrows indicate the direction of pull to remove the connectors.

1. Make the panel cutout using the mounting template dimensions in this chapter.
2. Check that the rubber gasket lies in its slot at the back of the bezel. Insert the limit into the panel cutout. Slide the retention collar over the limit, with the locating holes facing the back of the limit.
3. Slide the mounting bracket over the back of the limit with the screw tips pointed toward the panel, aligning with the locating holes in the retention collar. Push it gently but firmly over the limit until the hooks snap into the slots at the front.
4. If the installation does not require an IP65/NEMA 4X seal, tighten the four screws with the Phillips screwdriver just enough to eliminate the spacing between the rubber gasket and the panel.

For an IP65/NEMA 4X seal, tighten the four screws until the gap between the bezel and panel surface is 0.5 mm (0.020 in) maximum. Make sure that you cannot move it back and forth in the cutout. If you can, you do not have a proper seal. Do not over-tighten. Over-tightening could damage the mounting bracket.

Removing the 1/4 DIN Series SD Limit

1. Remove the terminal cover and all of the wiring connectors from the back of the limit. Using the Phillips screwdriver, unscrew the four screws on the mounting bracket (two on top, two on bottom) until they disengage from the retention collar.
2. Slide the tip of a flat screwdriver between the limit and the center top side of the mounting bracket. Rotate the screwdriver 90 degrees, stretching the bracket away from the limit so the hooks on the bracket disengage from the slots. Hold the bracket and press the limit forward slightly to prevent the disengaged hooks from snapping back into the slots.
3. Repeat this operation to disengage the hooks on the bottom side of the mounting bracket.
4. Press with one or two fingers on the lower half of the back of the unit so that the limit slides forward toward the panel. Hold the bracket steady; do not pull back. Be ready to support it as it comes through the front panel.

Series SD Family — Back Views in Scale

NOTE: The SD model number determines which diagram applies to your unit.

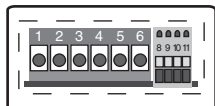

Figure 10a — 1/32 DIN
(S D 3 L - _ J _ _ - _ _ _).

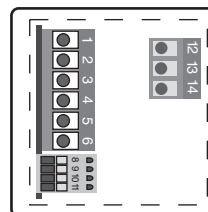

Figure 10b — 1/16 DIN
(S D 6 L - _ J _ _ - _ _ _).

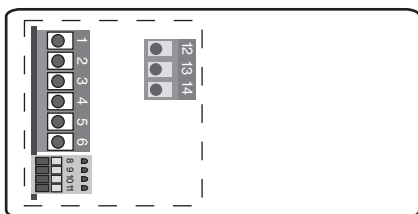

Figure 10c — 1/8 DIN Horizontal
(S D 9 L - _ J _ _ - _ _ _).

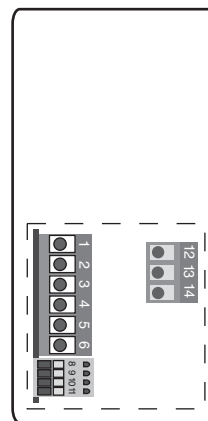

Figure 10d — 1/8 DIN Vertical
(S D 8 L - _ J _ _ - _ _ _).

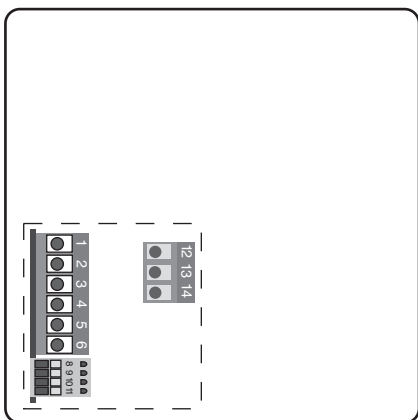

Figure 10e — 1/4 DIN
(S D 4 L - _ J _ _ - _ _ _).

NOTE:
Terminals 12, 13 and 14
are not installed on con-
trollers without an output 3
(SD _ L - _ J _ A - _ _ _).



Warning:
Use National Electric (NEC) or other country-specific standard wiring and safety practices when wiring and connecting this limit to a power source and to electrical sensors or peripheral devices. Failure to do so may result in damage to equipment and property, and/or injury or loss of life.

Note: To prevent ground loops, isolation needs to be maintained from input to output when using switched DC or analog process outputs.



WARNING: If high voltage is applied to a low-voltage limit, irreversible damage will occur.

Wiring the Series SD

Isolation Blocks

There are no electrical connections between these blocks.

Sensor Input
Switched DC Outputs
Analog Process Outputs

Power Supply Input

EIA/TIA-485 Communications Input

Relay outputs (mechanical and solid-state) provide isolation through their relay contacts. Each relay output is isolated from the blocks above and is isolated from other relay outputs.

The model number for each output option appears with its wiring diagram. Check the label on the limit and compare your model number to those shown here and to the model number breakdown in the Appendix of this manual.

The connectors on the back of the Series SD are different for different model numbers.

All outputs are referenced to a de-energized state.

All wiring and fusing must conform to the National Electric Code and to any locally applicable codes as well.

Figure 11a — High Voltage AC Power Wiring

SD_ L - H J _ _ - _ _ _ High

- Nominal voltage: 100 to 240V~ (ac)

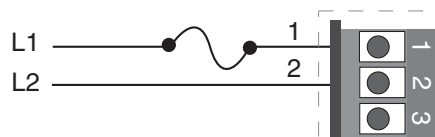
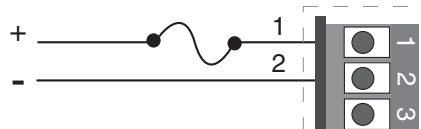

Figure 11b — Low Voltage AC Power Wiring

SD_ L - L J _ _ - _ _ _ Low

- Nominal voltage: 24V (ac/dc)
- Class 2 power source required for agency compliance





Warning:

Use National Electric (NEC) or other country-specific standard wiring and safety practices when wiring and connecting this limit to a power source and to electrical sensors or peripheral devices. Failure to do so may result in damage to equipment and property, and/or injury or loss of life.

Spring clamp wiring connector note:

To insert the wire, push the wire into the desired connection number, and it should automatically lock into place. To remove the wire, press and hold the orange release tab with a small screwdriver. Pull the wire out of the connection. Solid or tinned wire recommended.

Note: To prevent ground loops, isolation needs to be maintained from input to output when using switched DC or analog process outputs.



WARNING: Process input may not have sensor break protection. Outputs can remain full on. Check your input settings.

Figure 12a — Thermocouple Input

(all model numbers)

Thermocouples are polarity sensitive. The negative lead (usually red) must be connected to terminal 11.

- Input impedance: >20 MΩ

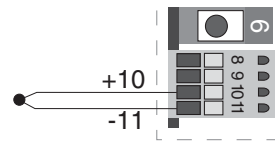

Figure 12b — RTD Input (100 Ω DIN curve 0.00385 Ω/Ω/°C)

(all model numbers)

Terminals 8 and 11 must be shorted for a two-wire RTD. For three-wire RTDs, the S1 lead (usually white) must be connected to terminal 10.

- Nominal excitation current: 390 μA

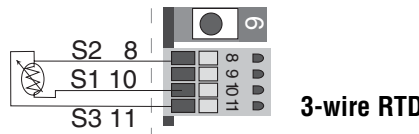
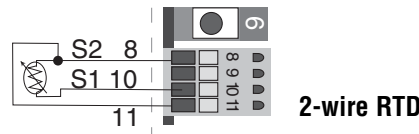

Figure 12c — 0 to 10V_{DC} (dc) Process Input

(all model numbers)

- Input impedance 20 kΩ, dc only.

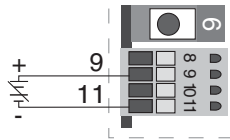
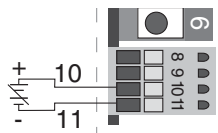

Figure 12d — 0 to 50mV_{DC} (dc) Process Input

(all model numbers)

- Input impedance >20 MΩ, dc only.





WARNING: Process input may not have sensor break protection. Outputs can remain full on. Check your input settings.



Warning:
Use National Electric (NEC) or other country-specific standard wiring and safety practices when wiring and connecting this limit to a power source and to electrical sensors or peripheral devices. Failure to do so may result in damage to equipment and property, and/or injury or loss of life.

Quencharc Note:
Switching inductive loads (relay coils, solenoids, etc.) with the mechanical relay, switched dc or solid-state relay output options requires use of an R.C. suppressor.

Watlow carries the R.C. suppressor Quencharc brand name, which is a trademark of ITW Paktron. Watlow Part No. 0804-0147-0000.

Spring clamp wiring connector note:
To insert the wire, push the wire into the desired connection number, and it should automatically lock into place. To remove the wire, press and hold the orange release tab with a small screwdriver. Pull the wire out of the connection. Solid or tinned wire recommended

Note: To prevent ground loops, isolation needs to be maintained from input to output when using switched DC or analog process outputs.

Figure 13a — 4 to 20 mA Process Input

(all model numbers)

- Input impedance 100 Ω , dc only.
- Limit does not supply power for the current loop.

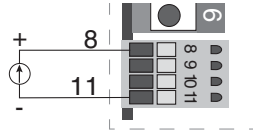

Figure 13b — Output 1 Mechanical Relay

SD_ L - _ J _ _ _ _ _

- 2 A, Form A.
- 240V~ (ac) maximum.
- 30V= (dc) maximum.
- See Quencharc note.
- For use with ac or dc.
- Minimum load current 10 mA
- Output does not supply power.

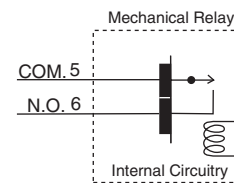
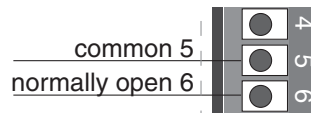
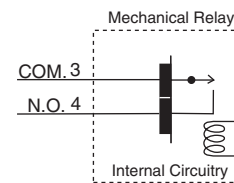
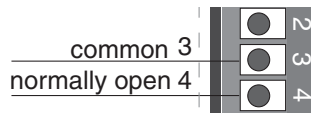

Figure 13c — Output 2 Mechanical Relay

SD_ L - _ J _ _ _ _ _

- 2 A; Form A.
- 240V~ (ac) maximum.
- 30V= (dc) maximum.
- See Quencharc note.
- For use with ac or dc.
- Minimum load current: 10 mA
- Output does not supply power.





Warning:

Use National Electric (NEC) or other country-specific standard wiring and safety practices when wiring and connecting this limit to a power source and to electrical sensors or peripheral devices. Failure to do so may result in damage to equipment and property, and/or injury or loss of life.

Quencharc Note:

Switching inductive loads (relay coils, solenoids, etc.) with the mechanical relay, switched dc or solid-state relay output options requires use of an R.C. suppressor.

Watlow carries the R.C. suppressor Quencharc brand name, which is a trademark of ITW Paktron. Watlow Part No. 0804-0147-0000.

Note: To prevent ground loops, isolation needs to be maintained from input to output when using switched DC or analog process outputs.

Figure 14a — Output 2 Solid-state Relay

SD_ L - _ _ _ **K** _ - - - - -

- 0.5 A maximum, Form A.
- 24 to 240V~ (ac).
- See Quencharc note.
- Minimum load current 10mA
- Maximum leakage current 100µA
- Not for use with direct current (dc).
- Output does not supply power

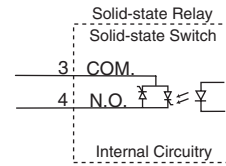
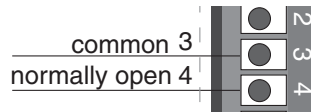

Figure 14b — Output 2 Switched DC

SD_ L - _ _ _ **C** _ - - - - -

- Maximum supply current 30 mA= (dc).
- Supply voltage 6 to 12V= (dc).
- Not recommended for switching mechanical relays.
- Output supplies power.

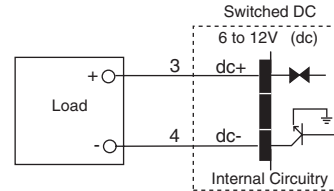
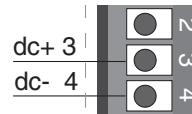
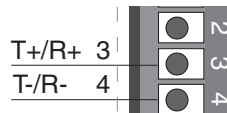

Figure 14c — Output 2 EIA/TIA-485

SD_ L - _ _ _ **U** _ - - - - -

- Isolated [50V= (dc)]
- Half duplex
- For more communications information, see the Features chapter.





Warning:

Use National Electric (NEC) or other country-specific standard wiring and safety practices when wiring and connecting this limit to a power source and to electrical sensors or peripheral devices. Failure to do so may result in damage to equipment and property, and/or injury or loss of life.

Quencharc Note:

Switching inductive loads (relay coils, solenoids, etc.) with the mechanical relay, switched dc or solid-state relay output options requires use of an R.C. suppressor.

Watlow carries the R.C. suppressor Quencharc brand name, which is a trademark of ITW Paktron. Watlow Part No. 0804-0147-0000.

Note: To prevent ground loops, isolation needs to be maintained from input to output when using switched DC or analog process outputs.

Figure 15a — Output 3 Mechanical Relay

SD_ L - _ _ _ E - _ _ _ _

- 5 A; Form C.
- 240V~ (ac) maximum.
- 30V= (dc) maximum.
- See Quencharc note.
- For use with ac or dc.
- Minimum load current: 10 mA
- Output does not supply power.

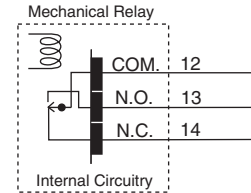
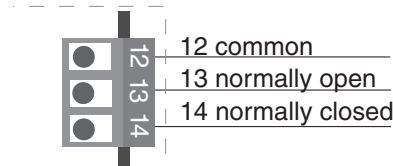

Figure 15b — Output 3 Solid-state Relay

SD_ L - _ _ _ K - _ _ _ _

- 0.5 A maximum, Form A.
- 24 to 240V~ (ac).
- See Quencharc note.
- Minimum load current 10 mA
- Maximum leakage current 100 μA
- Not for use with direct current (dc).
- Output does not supply power.

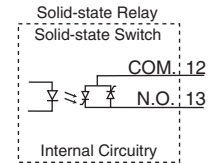
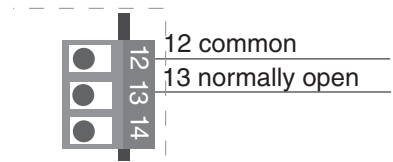
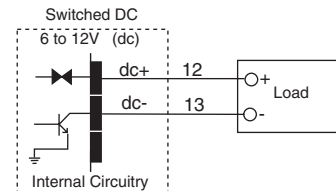
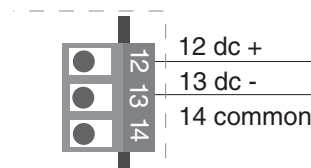

Figure 15c — Output 3 Switched DC

SD_ L - _ _ _ C - _ _ _ _

- Maximum supply current 30 mA= (dc).
- Supply voltage 6 to 12V= (dc).
- Not for switching mechanical relays.
- Output supplies power.





Warning:

Use National Electric (NEC) or other country-specific standard wiring and safety practices when wiring and connecting this limit to a power source and to electrical sensors or peripheral devices. Failure to do so may result in damage to equipment and property, and/or injury or loss of life.

Quencharc Note:

Switching inductive loads (relay coils, solenoids, etc.) with the mechanical relay, switched dc or solid-state relay output options requires use of an R.C. suppressor.

Watlow carries the R.C. suppressor Quencharc brand name, which is a trademark of ITW Paktron. Watlow Part No. 0804-0147-0000.

Note: To prevent ground loops, isolation needs to be maintained from input to output when using switched DC or analog process outputs.

Figure 16a — **Output 3 Open Collector**

SD_ L - _ _ _ C - _ _ _ _

- Maximum current sink 250 mA \approx (dc).
- Maximum supply voltage 42V \approx (dc).
- For inductive loads, see Quencharc note.
- Output does not supply power.

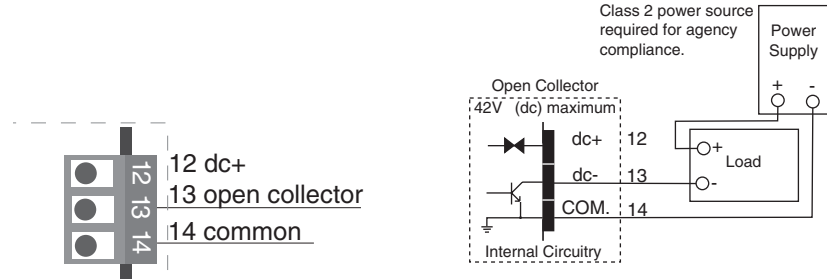
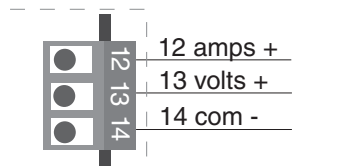

Figure 16b — **Output 3 Process**

SD_ L - _ _ _ F - _ _ _ _

- Analog output scalable from 0 to 10V \approx (dc) or 0 to 20 mA \approx (dc).
- Load capability: voltage, 1 k Ω minimum; current, 800 Ω maximum.
- Output supplies power.
- Cannot use voltage and current output at the same time.



Selecting an EIA/TIA-232 to EIA/TIA-485 Converter

When choosing an EIA/TIA 232 to 485 converter, look for one with the following features:

Two-wire capability

EIA/TIA-485 can be implemented as a two-wire system or a four-wire system. Most Watlow controllers, including the Series SD limit, use two-wire communications when working with EIA/TIA-485. The converter selected must have a two-wire mode. Some converters can only be used in a four-wire mode.

Automatic Send Data control

In a two-wire system, both the transmitted signals and the received signals travel over the same pair of wires, so the converter must have a method of changing from the transmit mode to the receive mode. Some converters require the toggling of a control line (usually the RTS line) to perform this transition, while others use an automatic timing circuit. The toggling method is dependent on the PC software to toggle the control line and the PC's operating system to make that transition happen in a timely manner. Because of these dependencies, the best choice for a converter is one with automatic control.

Isolation

Converters are available with or without input-to-output isolation. An isolated converter is not a requirement when used with the Series SD, but it is recommended to avoid ground loops. Also, isolation could be a consideration when the Series SD will be used on a network with other devices that may require isolation.

Power Supply

Many converters can be powered up either through the signals of a serial port or through an external power supply. Because some computers, such as laptops, do not always provide enough power to supply the converter, we recommend using an external power supply with specifications as recommended by the converter manufacturer. Isolated converters may require two supplies.

Biasing and termination

If the system does not work properly, it may need termination resistors at each end of the network. A typical installation would require a 120-ohm resistor across the transmit/receive terminals (3 and 4) of the last controller in the network and the converter box. Pull-up and pull-down resistors may be needed at the converter to maintain the correct voltage during the idle state. The pull-up resistor is connected between the positive of the DC supply and the T+/R+ terminal. The pull-down resistor is connected between the negative of the DC supply and the T-/R- terminal.

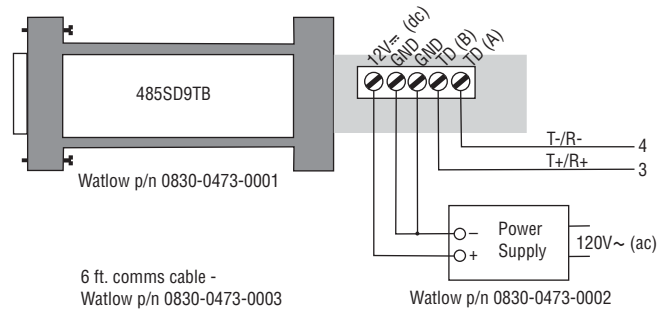

Figure 17a — B&B Converter.
Isolated converter - 485019TB
Non-isolated converter - 485SD9TB
B&B Electronics Manufacturing Company,
(815) 433-5100, <http://www.bb-elec.com/>

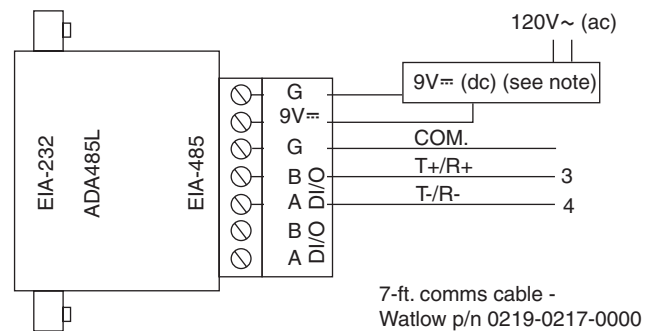

Figure 17b — CMC Converter.
Non-isolated converter - ADA485L
CMC Connecticut Micro-Computer, Inc.,
1-800-426-2872, <http://www.2cmc.com/>

NOTE:

The CMC converter requires an external power supply when used with a laptop computer.

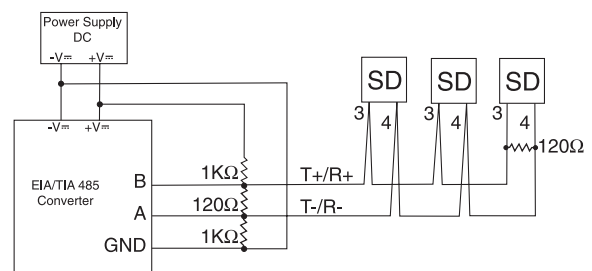

Figure 17c — Wiring bias and termination resistors.
Controllers must be wired in a daisy chain configuration.
Add a 120Ω termination resistor on the last controller.

Notes

3

Keys and Displays

1/32 DIN



1/16 DIN

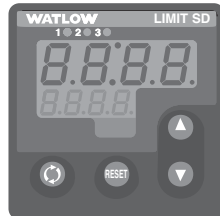

1/8 DIN Horizontal

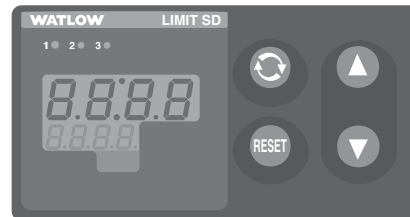

1/8 DIN Vertical



1/4 DIN

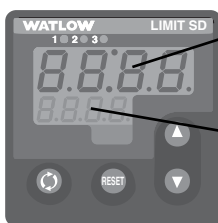
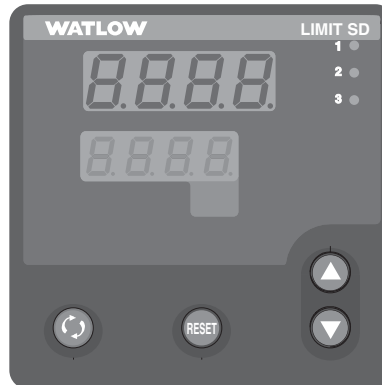



Upper Display (Left Display on 1/32 DIN): Indicates the process in the Home Page, or the value of the parameter in the lower display in other pages.

Lower Display (Right Display on 1/32 DIN): Indicates the set point or output power value during operation, or the parameter whose value appears in the upper display.

1/32 DIN



 **Advance Key**
Advances the lower display through parameter prompts.

 **RESET Key**

- Returns to the Home Page.
- Resets a latching alarm
- Resets a latching input sensor error.
- Resets the limit.
- Silence an alarm

 **Up and Down Keys**

In the Home Page, adjusts the limit set point.
In other pages, changes the upper display to a higher or lower value.

Active Output Indicator Lights
Lit when the corresponding limit or alarm output is tripped.

Note: After 60 seconds with no key presses, the controller reverts to the Home Page.

Home Page Overview

The Home Page is the default display of the Series SD limit controller. When the limit is powered up or you exit any other page, the Home Page appears. The parameters that appear in the Home Page are determined by the Display Look settings in the Setup Page (see Chapter 5). The process value is the default for the upper display and the High Limit Set Point is the default for the lower display. Press the RESET key to exit any other page and return to the Home Page display.

The Home Page also displays operational status information such as error messages, limit status and alarm status.

Normal Operation (Default Displays)

Operating in Safe Condition.

Process Value
 Limit high set point (Use Up ▲ or Down ▼ keys to raise or lower the high limit set point.)

Limit Tripped Operation

Operating in Limit Condition

Process Value

Limit message alternates with high limit set point in lower display. Output 1 indicator light is on.

Error condition

Dashed lines
 Error message Error message
 alternates with limit and/or alarm messages in lower display

Alarm Message

Process value
 Alarm message alternates in lower display.
 The corresponding output indicator light is on.

Adjusting the limit set point value

Adjust the limit set point in the Operations Page. Limit set points only appear if they are active and they have been selected to appear due to settings in the Programmable Page.

To adjust the limit set point:

1. Be sure the display is at the Home Page. If you are in any other page, press the RESET Key.
2. Press the Advance Key ⏩ to step into the Operations Page.
3. Continue pressing the Advance Key ⏩ until the desired limit set point parameter appears in the lower display. The limit value appears in the upper display.
4. Press the UP Key ▲ to increase the value or the DOWN Key ▼ to decrease the value.
5. Press the Advance Key ⏩ to step to other limit set point parameters and repeat steps 3 and 4. Press the RESET Key to return to the Home Page

Note: The parameter can lock the ability to adjust/view the settings in the Operation Page. If you are have trouble adjusting the limit set points, check the setting in the Setup Page.

Operations Page Overview

The Operations Page contains parameters accessed during normal day-to-day operation. The Series SD provides a patented user-definable menu system, allowing the user to customize the Operations Page contents. To go to the Operations Page, press the Advance Key ⏩ once from the Home Page.

- Press the Advance Key ⏩ to move through the parameter prompts. At the end of the operations parameters, press the Advance Key ⏩ to return to the Home Page.
- Press the Up ▲ or Down ▼ keys to change the parameter value.
- Press the RESET Key at any time to return to the Home Page.

Operations Page (defaults)

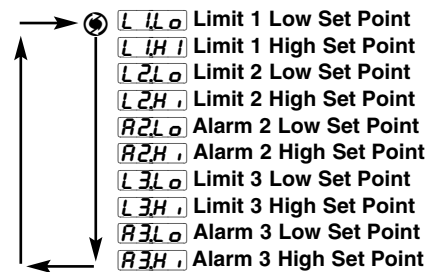





Note: Hardware configuration and programming selections determine what parameters appear on the Operations Page.

Setup Page Overview

**SEE
PAGE**

The Setup Page contains parameters that define the basic limit functions. Go to the Setup Page for initial configuration or if your application requirements change. Be sure to program the Setup Page first!

To go to the Setup Page, press both the Up  and Down  keys for three seconds from the Home Page.

- Press the Advance Key  to move through the parameter prompts.
- Press the Up  or Down  keys to change the parameter value.
- Press the RESET Key at any time to return to the Home Page.

Note: Hardware configuration and programming selections determine what parameters appear in the Setup Page.

Setup Page

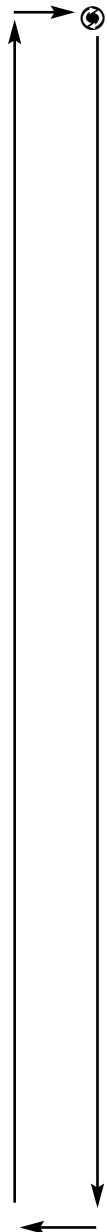

SEn	Sensor Type
LIn	Linearization
C-F	Temperature Units
SDEC	Temperature Decimal Places
PdEC	Process Decimal Places
ISEn	InfoSense Enable
ISP1	InfoSense Point 1
ISP2	InfoSense Point 2
ISP3	InfoSense Point 3
ISP4	InfoSense Point 4
ScLo	Process Scale Low
ScHi	Process Scale High
PILe	Process Input Low Error
PIHe	Process Input High Error
r9Lo	Units Scale Low
r9Hi	Units Scale High
SPLo	Set Point Low Limit
SPHi	Set Point High Limit
CRl	Calibration Offset
FEE	Enable Input Filter
FLt	Filter Value
DE 1	Output 1 Function
LSd1	Limit 1 Sides
hYS1	Limit 1 Hysteresis
DE 2	Output 2 Function
LSd2	Limit 2 Sides
hYS2	Alarm or Limit 2 Hysteresis
LGc2	Alarm 2 Logic
LRt2	Alarm 2 Latching
SIL2	Alarm 2 Silencing
dSP2	Alarm 2 Message
DE 3	Output 3 Function
LSd3	Limit 3 Sides
hYS3	Alarm or Limit 3 Hysteresis
LGc3	Alarm 3 Logic
LRt3	Alarm 3 Latching
SIL3	Alarm 3 Silencing
dSP3	Alarm 3 Message
AO3U	Analog Output 3 Units
03Lo	Analog Output 3 Scale Low
03Hi	Analog Output 3 Scale High
r3So	Output 3 Retransmit Source
r3Lo	Output 3 Retransmit Low Scale
r3Hi	Output 3 Retransmit High Scale
r3CO	Output 3 Retransmit Offset
IErr	Input Error Latching
UdSP	Upper Display Look
LdSP	Lower Display Look
Rddr	Modbus Device Address
bAud	Baud Rate
LOC	Lockout *



*Note: For FM Approval, the **LOC** parameter must be set to 3 or the limit must be remotely mounted to restrict casual user adjustment.

Programming Page Overview

Prog
Page

The Programming Page determines what parameters the user wants to appear in the Operations Page. Select a parameter for any of the 16 Programming Page locations, P1 to P16. These now appear in the Operations Page. All 16 locations have parameters selected as defaults.

To go to the Programming Page, hold down the RESET key, then press the Advance Key , and hold both down for about six seconds.

- Press the Advance Key  to move through the parameter prompts.
- Press the Up  or Down  keys to change the parameter value.
- Press the RESET Key at any time to return to the Home Page.

Note: The hardware configuration and programming selections will also determine what parameters appear in the Operations Page. A Programming Page selection will not appear in the Operations Page if the parameter is not active.

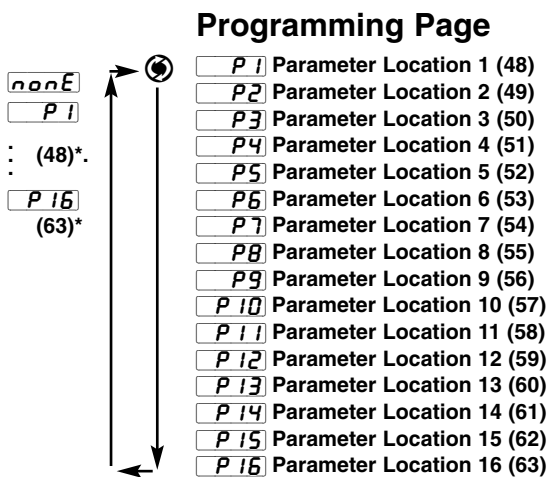





*Programming Page parameters Modbus register numbers P1 through P16 are 48 through 63

Factory Page Overview

Fact
Page

The Factory Page contains information on diagnostics, calibration and restore-parameter functions.

To go to the Factory Page, press both the Up  and Down  keys for six seconds from the Home Page.

- Press the Advance Key  to move through the parameter prompts.
- Press the Up  or Down  keys to change the parameter value of Read/Write (R/W) parameters.
- Press the RESET Key at any time to return to the Home Page.

Note: Hardware configuration and programming selections determine what parameters appear in the Factory Page.

Factory Page

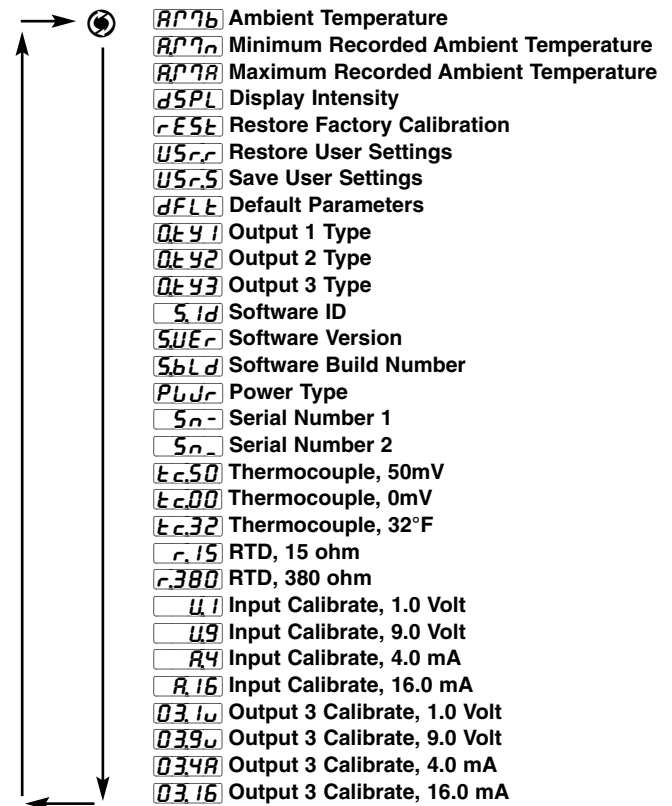

Calibration information for the Series SD controllers is available in pdf format. Go to www.watlow.com > Literature > Product User Manuals and search on *Series SD Calibration Manual*.

4 Home Page

Press the RESET Key at any time to go to the Home Page.

Depending upon the controller's status, you will see some combination of the parameters listed below. Normally, you will see the Process Value in the upper display and the Limit 1 High Set Point in the lower display. You cannot adjust Home Page parameters from the front panel keys. See Home Page Overview in Chapter Three.

After 60 seconds with no key presses, the controller reverts to the Home Page.

Display	Parameter Name Description	Settings	Range (Integer values for Modbus in parenthesis.)	Default	Modbus* (less 40,001 offset) Read/Write	Appears if:
Measured Value	Process Value Displays the current process value in the upper (left in 1/32 DIN) display.		-1999 to 9999 degrees °F or units (-1999000 to 9999000)	NA	*20, 21 R	There is no input error and [FErrE] is set to [OFF] or [Cont] .
Measured Value	Filtered Process Value Displays the current filtered process value in the upper (left in 1/32 DIN) display.		-1999 to 9999 degrees °F or units (-1999000 to 9999000)	NA	*22, 23 R	There is no input error and [FErrE] is set to [d.SP] or [both] .
Set Value	Limit 1 High Set Point Displays the high limit set point value for Output 1 in the lower (right in the 1/32 DIN) display.		[SPLo] to [SPHi]	75	*104, 105 R/W	[L5d1] is set to [both] or [h,9h] .
[ErrIn]	Input Error Indicate an input error state.		None (0) [----] Error (1)	NA	24 R	There is an analog input error.
[L1Lo]	Limit Low 1 Status Indicate a low limit at output 1.		None (0) Limit (1)	NA	29 R	Output 1 is in the low limit condition.
[L1Hi]	Limit High 1 Status Indicate a high limit at output 1.		None (0) Limit (1)	NA	30 R	Output 1 is in the high limit condition.
[L2Lo]	Limit Low 2 Status Indicate a low limit at output 2.		None (0) Limit (1)	NA	31 R	Output 2 is in the low limit condition.
[L2Hi]	Limit High 2 Status Indicate a high limit at output 2.		None (0) Limit (1)	NA	32 R	Output 2 is in the high limit condition.
[A2Lo]	Alarm Low 2 Status Indicate a low alarm at output 2.		None (0) Alarm (1)	NA	31 R	Output 2 is in the low alarm condition.
[A2Hi]	Alarm High 2 Status Indicate a high alarm at output 2.		None (0) Alarm (1)	NA	32 R	Output 2 is in the high alarm condition.
[L3Lo]	Limit Low 3 Status Indicate a low limit at output 3.		None (0) Limit (1)	NA	33 R	Output 3 is in the low limit condition.
[L3Hi]	Limit High 3 Status Indicate a high limit at output 3.		None (0) Limit (1)	NA	34 R	Output 3 is in the high limit condition.
[A3Lo]	Alarm Low 3 Status Indicate a low alarm at output 3.		None (0) Alarm (1)	NA	33 R	Output 3 is in the low alarm condition.
[A3Hi]	Alarm High 3 Status Indicate a high alarm at output 3.		None (0) Alarm (1)	NA	34 R	Output 3 is in the high alarm condition.

Note: Some values will be rounded off to fit in the four-character display. Full values can be read with Modbus. All temperature parameters are in °F through Modbus.



* Low register numbers contain the two higher bytes; high register numbers contain the two lower bytes of the four-byte integer. Decimal precision is implied at three decimal places unless otherwise noted.

5

Setup Page

To go to the Setup Page, press both the Up  and Down  keys for three seconds from the Home Page.

SEn will appear in the upper display and **PRGE** will appear in the lower display.

- Press the Advance Key  to move through the parameter prompts.
- Press the Up  or Down  keys to change the parameter value.
- Press the RESET Key at any time to return to the Home Page display.

Display	Parameter Name Description	Settings	Range (Integer values for Modbus in parentheses.)	Default	Modbus* (less 40,001 offset) Read/Write	Appears if:
SEn [SEn]	Sensor Type Set the analog sensor type.		tc (0) rtd (1) r7R (2) uolt (3) r7u (5)	tc (0)	70 R/W	Always active.
Lin [Lin]	Thermocouple Linearization Set the analog input thermocouple linearization.		J J (0) d D (6) H K (1) Pt11 PT11 (7) T T (2) R R (8) E E (3) S S (9) N N (4) B B (10) C C (5)	J (0)	71 R/W	SEn is set to tc .
C-F [C-F]	Temperature Units Set the temperature units for thermocouple and RTD inputs.		F Fahrenheit (0) C Celsius (1)	F (0)	40 R/W	SEn is set to tc or rtd .
SdEC [S.dEC]	Temperature Decimal Places Set the decimal places for the displayed input value for thermocouple and RTD types.		0 (0) 00 (1)	0 (0)	41 R/W	SEn is set to tc or rtd .
PdEC [P.dEC]	Process Decimal Places Set the decimal places for the displayed input value for process types.		0 (0) 00 (1) 000 (2) 0000 (3)	0 (0)	42 R/W	SEn is set to r7R , uolt , or r7u .
ISEn [IS.En]	INFOSENSE™ Enable the sensor feature, which synchronizes the controller with a Watlow sensor.		no (0) YES (1)	no (0)	91 R/W	Always active.
ISP1 [IS.P1]	INFOSENSE™ 1 Set sensor point 1 code.		0 to 999	500	92 R/W	ISEn is set to YES .
ISP2 [IS.P2]	INFOSENSE™ 2 Set sensor point 2 code.		0 to 999	500	93 R/W	ISEn is set to YES .
ISP3 [IS.P3]	INFOSENSE™ 3 Set sensor point 3 code.		0 to 999	500	94 R/W	ISEn is set to YES .
ISP4 [IS.P4]	INFOSENSE™ 4 Set sensor point 4 code.		0 to 999	500	95 R/W	ISEn is set to YES .

Note: Some values will be rounded off to fit in the four-character display. Full values can be read with Modbus. All temperature parameters are in °F through Modbus.

* Low register numbers contain the two higher bytes; high register numbers contain the two lower bytes of the four-byte integer. Decimal precision is implied at three decimal places unless otherwise noted.

Display	Parameter Name Description	Settings	Range (Integer values for Modbus in parentheses.)	Default	Modbus* (less 40,001 offset) Read/Write	Appears if:
[Sc.Lo] [Sc.Lo]	Process Scale Low Set the low scale for process inputs.		1.00 to 20.00 mA: if [SEn] is set to [r7A] (1000 to 20000) 0.50 to 10.00V: if [SEn] is set to [u0LE] (500 to 10000) 10.00 to 50.00 mV: if [SEn] is set to [r7u] (10000 to 50000)	4.00 mA 1.00V 10.00 mV	*73, 74 R/W (mA) *77, 78 R/W (V) *331, 332 R/W (mV)	[SEn] is set to [r7A] , [SEn] is set to [u0LE] , [SEn] is set to [r7u] .
[Sc.hi] [Sc.hi]	Process Scale High Set the high scale for process inputs.		1.00 to 20.00 mA: if [SEn] is set to [r7A] (1000 to 20000) 0.50 to 10.00V: if [SEn] is set to [u0LE] (500 to 10000) 10.00 to 50.00 mV: if [SEn] is set to [r7u] (10000 to 50000)	20.00 mA 5.00V 50.00 mV	*75, 76 R/W (mA) *79, 80 R/W (V) *333, 334 R/W (mV)	[SEn] is set to [r7A] , [SEn] is set to [u0LE] , [SEn] is set to [r7u] .
[P1.LE] [P1.LE]	Process Input Low Error Set the low process value that will cause an error to occur for the process input.		1.00 to 10.00 mA (100 to 1000) 0.50 to 5.00 V (050 to 500) 5.00 to 25.00 mV (500 to 2500) (two decimal places implied for Modbus)	1.00 mA 0.50 V 5.00 mV	325 R/W (mA) 327 R/W (V) 329 R/W (mV)	[SEn] is set to [r7A] , [SEn] is set to [u0LE] , [SEn] is set to [r7u] .
[P1.HE] [P1.HE]	Process Input High Error Set the high process value that will cause an error to occur for the process input.		10.00 to 20.00 mA (1000 to 2000) 5.00 to 10.00 V (500 to 1000) 25.00 to 50.00 mV (2500 to 5000) (two decimal places implied for Modbus)	20.00 mA 10.00 V 50.00 mV	326 R/W (mA) 328 R/W (V) 330 R/W (mV)	[SEn] is set to [r7A] , [SEn] is set to [u0LE] , [SEn] is set to [r7u] .
[rg.Lo] [rg.Lo]	Units Scale Low Set the low range for process input units.		-1999 to 9999 (-1999000 to 9999000) (Set precision with [PdEC] , Process Decimal Places.)	-1999	*81, 82 R/W	[SEn] is set to [r7A] or [u0LE] .
[rg.hi] [rg.hi]	Units Scale High Set the high range for process input units.		-1999 to 9999 (-1999000 to 9999000) (Set precision with [PdEC] , Process Decimal Places.)	9999	*83, 84 R/W	[SEn] is set to [r7A] or [u0LE] .
[SP.Lo] [SP.Lo]	Set Point Low Limit Set the low range for the set point.		Min. operating range (of sensor) to [SPHi] -0.100: if [SEn] is set to [tc] -328 to [SPHi] -0.100: if [SEn] is set to [rtd] -1999 to [SPHi] -0.001: if [SEn] is set to [r7A] , [u0LE] , or [r7u] . (Set precision with [PdEC] , Process Decimal Places.)	Min. operat- ing range (J type): [tc] -328: [rtd] -999: [r7A] , [u0LE] , and [r7u] .	*231, 232 R/W (ther- mocouple) *235, 236 R/W (RTD) *239, 240 R/W (mA, V, or mV)	Always active.

Note: Some values will be rounded off to fit in the four-character display. Full values can be read with Modbus. All temperature parameters are in °F through Modbus.

* Low register numbers contain the two higher bytes; high register numbers contain the two lower bytes of the four-byte integer. Decimal precision is implied at three decimal places unless otherwise noted.

Display	Parameter Name Description	Settings	Range (Integer values for Modbus in parentheses.)	Default	Modbus* (less 40,001 offset) Read/Write	Appears if:
[SPHi] [SPHi]	Set Point High Limit Set the high range for the set point.		[r9Lo] to max. operating range (of sensor): if [SEn] is set to [tc] [SPLo] +0.100 to 1472: if [SEn] is set to [rtd] [SPLo] +0.001 to 9999: if [SEn] is set to [r7R] , [u0LE] , or [r7u] . (Set precision with [PdEC] , Process Decimal Places)	Max. operating range (J type): [tc] 1472: [rtd] 999: [r7R] , [u0LE] , and [r7u] .	*233, 234 R/W (thermocouple) *237, 238 R/W (RTD) *241, 242 R/W (mA or V)	Always active.
[CAL] [CAL]	Calibration Offset Offset the input reading.		-999 to 999 (-999000 to 999000)	0	*85, 86 R/W	Always appears.
[Ftr.E] [Ftr.E]	Input Filter Select filtering action.		[OFF] (0) (no filtering) [d,SP] (1) (filter only the display value) [cont] (2) (filter the control input values) [both] (3) (filter the display and control input values)	[OFF] (0)	89 R/W	Always active.
[FLtr] [FLtr]	Filter Value Set the input filter value.		0.0 to 60.0 seconds (0000 to 60000)	0.0	*87, 88 R/W	[Ftr.E] is not set to [OFF] .
[Ot 1] [Ot 1]	Output 1 Function Set Output 1 function.		[LIP7] Limit (2)	[LIP7] (2)	143 R	Always active.
[LSd1] [LSd1]	Output 1 Limit Sides Selects Output 1 limit active sides.		[both] (0) (both high and low sides active) [h,9h] (1) (high side active) [low] (2) (low side active)	[both] (0)	111 R/W	Always active.
[hyS1] [hyS1]	Limit 1 Hysteresis Set the hysteresis for the limit. This determines how far into the safe region the input needs to move before the limit can be cleared.		0.0 to 999.0 (0000 to 999000)	1.0	*106, 107 R/W	Always active.
[Ot2] [Ot2]	Output 2 Function Set Output 2 function.		[OFF] Off (0) [PrAL] Process Alarm (1) [LIP7] Limit (2)	[OFF] (0)	164 R/W	Output 2 is installed and is not a communications output.
[LSd2] [LSd2]	Output 2 Limit Sides Selects Output 2 limit		[both] (0) (both high and low sides active) [h,9h] (1) (high side active) [low] (2) (low side active)	[both] (0)	126 R/W	[Ot 2] is set to [LIP7] .
[hyS2] [hyS2]	Output 2 Hysteresis Set the hysteresis for the output. This determines how far into the safe region the input needs to move before the output can be cleared.		0.0 to 999.0 (0000 to 999000)	1.0	*121, 122 R/W	[Ot 2] is set to [PrAL] or [LIP7] .
[Lgc2] [Lgc2]	Output 2 Logic Select the output condition in the alarm state.		[ALC] closed on alarm (0) [ALD] open on alarm (1)	[ALC] (0)	169 R/W	[Ot 2] is set to [PrAL] .

Note: Some values will be rounded off to fit in the four-character display. Full values can be read with Modbus. All temperature parameters are in °F through Modbus.

* Low register numbers contain the two higher bytes; high register numbers contain the two lower bytes of the four-byte integer. Decimal precision is implied at three decimal places unless otherwise noted.

Display	Parameter Name Description	Settings	Range (Integer values for Modbus in parentheses.)	Default	Modbus* (less 40,001 offset) Read/Write	Appears if:
[LAT2] [LAT2]	Alarm 2 Latching Turn alarm latching on or off.		[nLAT] off (0) [LAT] on (1)	[nLAT] (0)	123 R/W	[DE 2] is set to [PrAL] .
[SIL2] [SiL2]	Alarm 2 Silencing Turn alarm silencing on or off.		[OFF] off (0) no silencing [On] on (1) silencing	[OFF] (0)	124 R/W	[DE 2] is set to [PrAL] .
[dSP2] [dSP2]	Alarm 2 Message Displays an alarm message when an alarm is active.		[OFF] off (0) no message [On] on (1) message	[On] (1)	125 R/W	[DE 2] is set to [PrAL] .
[Ot 3] [Ot 3]	Output 3 Function Set Output 3 function.		[OFF] Off (0) [PrAL] Process Alarm (1) [LiM] Limit (2) [rTr] Retransmit (6)	[OFF] (0)	172 R/W	Output 3 is installed. Active only if Output 3 is a process output (SD_ _ _ _ F - _ _ _)
[LSd3] [LSd3]	Output 3 Limit Sides Selects Output 3 limit		[both] (0) (both high and low sides active) [h,gh] (1) (high side active) [LoLJ] (2) (low side active)	[both] (0)	141 R/W	[DE 3] is set to [LiM] .
[hyS3] [hyS3]	Output 3 Hysteresis Set the hysteresis for the output. This determines how far into the safe region the input needs to move before the output can be cleared.		0.0 to 999.0 (0000 to 999000)	1.0	*136, 137 R/W	[DE 3] is set to [PrAL] or [LiM] .
[Lgc2] [Lgc2]	Output 3 Logic Select the output condition in the alarm state.		[AL C] closed on alarm (0) [AL O] open on alarm (1)	[AL C] (0)	190 R/W	[DE 3] is set to [PrAL] .
[LAT3] [LAT3]	Alarm 3 Latching Turn alarm latching on or off.		[nLAT] off (0) [LAT] on (1)	[nLAT] (0)	138 R/W	[DE 3] is set to [PrAL] .
[SIL3] [SiL3]	Alarm 3 Silencing Turn alarm silencing on or off.		[OFF] off (0) no silencing [On] on (1) silencing	[OFF] (0)	139 R/W	[DE 3] is set to [PrAL] .
[dSP3] [dSP3]	Alarm 3 Message Displays an alarm message when an alarm is active.		[OFF] off (0) no message [On] on (1) message	[On] (1)	140 R/W	[DE 3] is set to [PrAL] .
[AO3.U] [AO3.U]	Analog Output 3 Units Set the analog process output units.		[mA] milliamperes (0) [vOLt] volts (1)	[mA] (0)	176 R/W	Output 3 is a process output. (SD_ _ _ _ F - _ _ _)

Note: Some values will be rounded off to fit in the four-character display. Full values can be read with Modbus. All temperature parameters are in °F through Modbus.

* Low register numbers contain the two higher bytes; high register numbers contain the two lower bytes of the four-byte integer. Decimal precision is implied at three decimal places unless otherwise noted.

Display	Parameter Name Description	Settings	Range (Integer values for Modbus in parentheses.)	Default	Modbus* (less 40,001 offset) Read/Write	Appears if:
03Lo [O3.Lo]	Analog Output 3 Scale Low Set the low scale for the process output.		0.00 to 20.00 mA if output is set to mA (0000 to 20000) 0.00 to 10.00V (0000 to 10000) if output is set to volts	4.00 mA 0.00V	*177, 178 R/W (mA) *181, 182 R/W (V)	Output 3 is a process output. (SD_ _ - _ _ _ F - _ _ _ _)
03Hi [O3.Hi]	Analog Output 3 Scale High Set the high scale for the process output.		0.00 to 20.00 mA if output is set to mA (0000 to 20000) 0.00 to 10.00V if output is set to volts (0000 to 10000)	20.00 mA 10.00V	*179, 180 R/W (mA) *183, 184 R/W (V)	Output 3 is a process output. (SD_ _ - _ _ _ F - _ _ _ _)
r3So [r3.So]	Output 3 Retransmit Source Set the control variable that the retransmit signal represents.	Proc Process Value (0) SP Set Point (1)		Proc (0)	315 R/W	Output 3 is a process output (SD_ _ - _ _ _ F - _ _ _ _) and 0E3 is set to rPnE .
r3Lo [r3.Lo]	Output 3 Retransmit Low Scale Set the low scale for the retransmit output.		-1999.0 to 9999.0 (-1999000 to 9999000)	0	*316, 317 R/W	Output 3 is a process output (SD_ _ - _ _ _ F - _ _ _ _) and 0E3 is set to rPnE .
r3Hi [r3.Hi]	Output 3 Retransmit High Scale Set the high scale for the retransmit output.		-1999.0 to 9999.0 (-1999000 to 9999000)	500	*318, 319 R/W	Output 3 is a process output (SD_ _ - _ _ _ F - _ _ _ _) and 0E3 is set to rPnE .
r3O [r3.Hi]	Output 3 Retransmit Offset Set the offset value for the retransmit output.		-999.0 to 999.0 (-999000 to 999000)	0	*320, 321 R/W	Output 3 is a process output (SD_ _ - _ _ _ F - _ _ _ _) and 0E3 is set to rPnE .
LErr [L.Err]	Input Error Latching Turn input error latching on or off.	nLE off (0) LE on (1)		nLE (0)	90 R/W	Always active.
UdSP	Upper Display Look Selects what value appears in the upper display.	none None (0) Proc (1) Process Value L1o Limit 1 Low Set Point (2) L1h Limit 1 High Set Point (3) L2o Limit 2 Low Set Point (4) L2h Limit 2 High Set Point (5) A2o Alarm 2 Low Set Point (6) A2h Alarm 2 High Set Point (7) L3o Limit 3 Low Set Point (8) L3h Limit 3 High Set Point (9) A3o Alarm 3 Low Set Point (10) A3h Alarm 3 High Set Point (11)		Proc (1)	44 R/W	Always active.

Note: Some values will be rounded off to fit in the four-character display. Full values can be read with Modbus. All temperature parameters are in °F through Modbus.

* Low register numbers contain the two higher bytes; high register numbers contain the two lower bytes of the four-byte integer. Decimal precision is implied at three decimal places unless otherwise noted.

Display	Parameter Name Description	Settings	Range (Integer values for Modbus in parentheses.)	Default	Modbus* (less 40,001 offset) Read/Write	Appears if:
LdSP	Lower Display Look Selects what value appears in the lower display.		none None (0) Proc (1) Process Value LLo Limit 1 Low Set Point (2) Lh Limit 1 High Set Point (3) L2Lo Limit 2 Low Set Point (4) L2h Limit 2 High Set Point (5) R2Lo Alarm 2 Low Set Point (6) R2h Alarm 2 High Set Point (7) L3Lo Limit 3 Low Set Point (8) L3h Limit 3 High Set Point (9) R3Lo Alarm 3 Low Set Point (10) R3h Alarm 3 High Set Point (11)	Lh (3)	45 R/W	Always active.
RdDr [Addr]	Modbus Device Address Set the device address for communications. Every controller on a network must have a unique address.		1 to 247	1	This can only be set from the controller front panel.	Output 2 is a communications output. (SD_ _ _ _ U _ _ _ _)
bAud [bAud]	Baud Rate Set the baud rate at which the communications occurs.		9600 192 384	9600	This can only be set from the controller front panel.	Output 2 is a communications output. (SD_ _ _ _ U _ _ _ _)
LdC [LOC]	Lockout Set the security level for the user interface. Note: For FM Approval, the LdC parameter must be set to 3 or the limit must be remotely mounted to restrict casual adjustment of limit set points.		0 (0) no lockout 1 (1) Programming Page locked and Setup Page locked except for LdC . 2 (2) Programming Page locked and Setup Page locked except for LdC . Limit set points are the only Operation Page parameters accessible. 3 (3) Full lockout. All pages locked except for Setup Page, LdC . See the Features Chapter for details.	0 (0)	43 R/W	Always active.

Note: Parameters appear in the Operations Page only if activated from the Programming Page.

Note: Some values will be rounded off to fit in the four-character display. Full values can be read with Modbus. All temperature parameters are in °F through Modbus.

*** Low register numbers contain the two higher bytes; high register numbers contain the two lower bytes of the four-byte integer. Decimal precision is implied at three decimal places unless otherwise noted.**

6

Operations Parameters Table

These parameters can be selected to appear in the Operations Page. Select parameters to appear in the Operations Page in the Programming Page.

Press the Advance Key  from the Home Page to enter the Operations Page. To return to the Home Page, press the RESET Key.

Display	Parameter Name Description	Settings	Range (Integer values for Modbus in parentheses.)	Default	Modbus* (less 40,001 offset) Read/Write	Appears if:
L1Lo [L1.Lo]	Limit 1 Low Set the low limit set point value for Output 1.		SPLo to SPh	74	*102, 103 R/W	LSd1 is set to both or LoU .
L1h [L1.hi]	Limit 1 High Set the high limit set point value for Output 1.		SPLo to SPh	75	*104, 105 R/W	LSd1 is set to both or h.9h .
L2Lo [L2.Lo]	Limit 2 Low Set the low limit set point value for Output 2.		SPLo to SPh	74	*117, 118 R/W	If DE2 is set to LIn and LSd2 is set to both or LoU .
L2h [L2.Lo]	Limit 2 High Set the low limit set point value for Output 2.		SPLo to SPh	75	*119, 120 R/W	If DE2 is set to LIn and LSd2 is set to both or h.9h .
A2Lo [A2.Lo]	Alarm 2 Low Set the low alarm set point for Output 2.		Process: range of sensor, if SEN is set to tc or rd -1999 to 9999 if SEN is set to RR , uolt , or rw . (-1999000 to 9999000)	32	*117, 118 R/W	If DE2 is set to PrAL
A2h [A2.hi]	Alarm 2 High Set the high alarm set point for Output 2.		Process: range of sensor, if SEN is set to tc or rd -1999 to 9999 if SEN is set to RR , uolt , or rw . (-1999000 to 9999000)	1500	*119, 120 R/W	If DE2 is set to PrAL
L3Lo [L3.Lo]	Limit 3 Low Set the low limit set point value for Output 3.		SPLo to SPh	74	*132, 133 R/W	If DE3 is set to LIn and LSd3 is set to both or LoU .
L3h [L3.Lo]	Limit 3 High Set the low limit set point value for Output 3.		SPLo to SPh	75	*134, 135 R/W	If DE3 is set to LIn and LSd3 is set to both or h.9h .
A3Lo [A3.Lo]	Alarm 3 Low Set the low alarm set point for Output 3.		Process: range of sensor, if SEN is set to tc or rd -1999 to 9999 if SEN is set to RR , uolt , or rw . (-1999000 to 9999000)	32	*132, 133 R/W	If DE3 is set to PrAL

Note: Parameters appear in the Operations Page only if activated from the Programming Page.

Note: Some values will be rounded off to fit in the four-character display. Full values can be read with Modbus.

* Low register numbers contain the two higher bytes; high register numbers contain the two lower bytes of the four-byte integer. Decimal precision is implied at three decimal places unless otherwise noted.

Display	Parameter Name Description	Settings	Range (Integer values for Modbus in parentheses.)	Default	Modbus* (less 40,001 offset) Read/Write	Appears if:
h3hi [A3.hi]	Alarm 3 High Set the high alarm set point for Output 3.		Process: range of sensor, if SEN is set to tc or rtd -1999 to 9999 if SEN is set to PtR , uOLE , or PtU . (-1999000 to 9999000)	1500	*134, 135 R/W	If DE 3 is set to PcRL
h51 [hyS1]	Limit 1 Hysteresis Set the hysteresis for the limit. This determines how far into the safe region the input needs to move before the limit can be cleared. This also appears in the Set-up Page.		0.0 to 999.0 (0000 to 999000)	1.0	*106, 107 R/W	Always active.
h52 [hyS2]	Output 2 Hysteresis Set the hysteresis for the alarm or limit output. This determines how far into the safe region the input needs to move before the output can be cleared.		0.0 to 999.0 (0000 to 999000)	1.0	*121, 122 R/W	DE 2 is set to PcRL or LIP .
h53 [hyS3]	Output 3 Hysteresis Set the hysteresis for the alarm or limit output. This determines how far into the safe region the input needs to move before the output can be cleared.		0.0 to 999.0 (0000 to 999000)	1.0	*136, 137 R/W	DE 3 is set to PcRL or LIP .
Addr [Addr]	Modbus Device Address Set the device address for communications. Every controller on a network must have a unique address.		1 to 247	1	This can only be set from the controller front panel.	Output 2 is a communications output. SD _ _ _ U _ _ _ _
C-F [C-F]	Temperature Units Set the temperature units for thermocouple and RTD inputs.		F Fahrenheit (0) C Celsius (1)	F (0)	40 R/W	SEN is set to tc or rtd .
CAL [CAL]	Calibration Offset Offset the input reading.		-999 to 999 (-999000 to 999000)	0	*85, 86 R/W	Always appears.





Note: Parameters appear in the Operations Page only if activated from the Programming Page.

Note: Some values will be rounded off to fit in the four-character display. Full values can be read with Modbus. All temperature parameters are in °F through Modbus.

* Low register numbers contain the two higher bytes; high register numbers contain the two lower bytes of the four-byte integer. Decimal precision is implied at three decimal places unless otherwise noted.

7 Programming Page

The Programming Page allows you to select what parameters appear on the Operations Page. To go to the Programming Page, press the Advance  and RESET keys for six seconds from the Home Page. **Prog** will appear in the upper display and **PAGE** in the lower display.

- Press the Advance Key  to move through the parameter prompts.
- Press the Up  or Down  keys to change the parameter value.
- Press the Infinity Key  at any time to return to the Home Page.

Display	Parameter Name Description	Settings	Range (Integer values for Modbus in parentheses.)	Default	Modbus* (less 40,001 offset) Read/Write	Appears if:
P1	Parameter Location 1		none (0) None	LLo (1)	48 R/W	All parameter locations always appear on the Programming Page.
P2	Parameter Location 2		LLo (1) Limit 1 Low LHi (2) Limit 1 High	LHi (2)	49 R/W	
P3	Parameter Location 3		LLo (3) Limit 2 Low LHi (4) Limit 2 High	LLo (3)	50 R/W	
P4	Parameter Location 4		LLo (5) Limit 3 Low LHi (6) Limit 3 High	LHi (4)	51 R/W	
P5	Parameter Location 5		ALo (7) Alarm 2 Low AHi (8) Alarm 2 High	ALo (7)	52 R/W	
P6	Parameter Location 6		ALo (9) Alarm 3 Low AHi (10) Alarm 3 High	AHi (8)	53 R/W	
P7	Parameter Location 7		HYS1 (11) Alarm Hysteresis 1 (Setup Page)	LLo (5)	54 R/W	
P8	Parameter Location 8		HYS2 (12) Alarm Hysteresis 2 (Setup Page)	LHi (6)	55 R/W	
P9	Parameter Location 9		HYS3 (13) Alarm Hysteresis 3 (Setup Page)	AHi (10)	56 R/W	
P10	Parameter Location 10		Addr (14) Modbus Device Address (Setup Page)	ALo (9)	57 R/W	
P11	Parameter Location 11		none (0)	none (0)	58 R/W	
P12	Parameter Location 12		C-F (15) Temperature Units (Setup Page)	none (0)	59 R/W	
P13	Parameter Location 13		CAL (16) Calibration Offset	none (0)	60 R/W	
P14	Parameter Location 14			none (0)	61 R/W	
P15	Parameter Location 15			none (0)	62 R/W	
P16	Parameter Location 16			none (0)	63 R/W	

Note: All Parameter locations have the same range of possible values.

Programming Page Example





An oven manufacturer wants the user's of their ovens to have easy access to the Series SD Limit parameters. They also want to limit access to other parameters they do not want them to change. This can be achieved by customizing the Operations Page. The Programming Page configuration determines which parameters appear on the Operations Page. The Series SD Limit controller has 16 Programming Page locations, P1 to P16.

The oven manufacturer wants only these parameters to appear on the Operations Page:

- Fahrenheit/Celsius
- Alarm 2 Low Set Point
- Alarm 2 High Set Point
- Modbus Address

To go to the Programming Page, press the Advance  and RESET keys for six seconds from the Home Page.

PROG will appear in the upper display and **PAGE** in the lower display.

- Press the Advance Key  to move through the parameter prompts.
- Press the Up  or Down  keys to change the parameter value.
- Press the Infinity Key  at any time to return to the Home Page.

On the Programming Page, select the following settings:

C-F	R2Lo	R2Hi	Addr	nonE	nonE
P1	P2	P3	P4	P5 thru	P16



To access the Operation Page parameters, press the RESET key to return to the Home Page. Press the Advance  key to see the Operation Page parameters. Only the parameters selected on the Programming Page appear on the Operations Page.

F	32	1000	1
C-F	R2Lo	R2Hi	Addr

8

Factory Page and Calibration

To go to the Factory Page, press both the Up  and Down  keys for six seconds from the Home Page. **FRct** will appear in the upper display and **PRGE** in the lower display.

- Press the  Advance Key to move through the parameter prompts.
- Press the Up  or Down  keys to change the parameter value.
- Press the RESET Key at any time to return to the Home Page.

Display	Parameter Name Description	Settings	Range (Integer values for Modbus in parentheses.)	Default	Modbus* (less 40,001 offset) Read/Write	Appears if:
RP7b [AMb]	Ambient Temperature Displays the current calculated ambient temperature.		-50.0 to 300.0°F	NA	268 R 269 R	Always active.
RP7n [A.Mn]	Minimum Recorded Ambient Temperature Displays the minimum recorded ambient temperature.		-50.0 to 300.0°F	NA	NA	Always active.
RP7R [A.MA]	Maximum Recorded Ambient Temperature Displays the maximum recorded ambient temperature.		-50.0 to 300.0°F	NA	NA	Always active.
dSPL [dSPL]	Display Intensity Increase or decrease the brightness of the upper and lower display.		15 to 100% duty	100	NA	Always active.
rESt [rESt]	Restore Factory Calibration Replaces the user calibration parameters with the factory calibration parameters.	<input type="checkbox"/> no (0) <input type="checkbox"/> YES (1)		<input type="checkbox"/> no (0)	199 R/W	Always active.
USr.r [Usr.r]	Restore User Settings Restores customer configured settings. Two sets of user settings are available.	<input type="checkbox"/> no (0) <input type="checkbox"/> SEt 1 (1) <input type="checkbox"/> SEt 2 (2)		<input type="checkbox"/> no (0)	200 R/W	Always active.
USr.S [Usr.S]	Save User Settings Saves customer configured settings. Two sets of user settings are available.	<input type="checkbox"/> no (0) <input type="checkbox"/> SEt 1 (1) <input type="checkbox"/> SEt 2 (2)		<input type="checkbox"/> no (0)	201 R/W	Always active.
dFLt [dFLt]	Default Parameters Reset all parameters to their default values.	<input type="checkbox"/> no (0) <input type="checkbox"/> YES (1)		<input type="checkbox"/> no (0)	198 R/W	Always active.
OEY 1 [O.ty1]	Output 1 Type Displays the hardware type for Output 1.		<input type="checkbox"/> rLAY mech. relay (2)	<input type="checkbox"/> rLAY mech. relay (2)	193 R	Always active.

Display	Parameter Name Description	Settings	Range (Integer values for Modbus in parentheses.)	Default	Modbus* (less 40,001 offset) Read/Write	Appears if:
OEY2 [O.ty2]	Output 2 Type Displays the hardware type for Output 2.		none none (0) DC DC/open collect. (1) RLRY mech. relay (2) SSR solid-state relay (3) COMM communications (5)	none (0)	194 R	Always active.
OEY3 [O.ty3]	Output 3 Type Displays the hardware type for Output 3.		none none (0) DC DC/open collect. (1) RLRY mech. relay (2) SSR solid-state relay (3) Proc process (4)	none (0)	195 R	Always active.
Sid [S.id]	Software ID Displays the software ID number.		0 to 9999	NA	10 R	Always active.
SVER [S.VEr]	Software Version Displays the firmware revision.		00.00 to 99.99	NA	11 R	Always active.
SbLd [S.bLd]	Software Build Number Displays the software build number.		0 to 9999 Build Number	NA	13 R	Always active.
PWDr [PWr]	Power Type Displays the type of input power.		AC (0) high voltage LDLJ (1) low voltage	NA	NA	Always active.
Sn- [Sn-]	Serial Number 1 Displays the first four characters of the serial number.		0 to 9999	NA	7, 8 R	Always active.
Sn_ [Sn_]	Serial Number 2 Displays the last four characters of the serial number.		0 to 9999	NA	7, 8 R	Always active.
tc.50 [tc.50]	Thermocouple, 50mV Calibrate the thermocouple input to 50mV (see "Calibrating the Series SD").		no YES	no	*NA	Always active.
tc.00 [tc.00]	Thermocouple, 0mV Calibrate the thermocouple input to 0mV (see "Calibrating the Series SD").		no YES	no	*NA	Always active.
tc.32 [tc.32]	Thermocouple, 32°F Calibrate the thermocouple input to 0°C (32°F) (see "Calibrating the Series SD").		no YES	no	*NA	Always active.
r.15 [r.15]	RTD, 15 ohm Calibrate the RTD input to 15 ohm (see "Calibrating the Series SD").		no YES	no	*NA	Always active.
r.380 [r.380]	RTD, 380 ohm Calibrate the RTD input to 380 ohms. (see "Calibrating the Series SD").		no YES	no	*NA	Always active.
V.1 [V.1]	Input Calibrate, 1.0 Volt Calibrate the process voltage input to 1.0 Volt (see "Calibrating the Series SD").		no YES	no	*NA	Always active.

* The Series SD controller can be calibrated only with the front panel controls. These parameters are not visible through serial communications.

Display	Parameter Name Description	Settings	Range (Integer values for Modbus in parentheses.)	Default	Modbus* (less 40,001 offset) Read/Write	Appears if:
<input type="checkbox"/> U9 [V.9]	Input Calibrate, 9.0 Volt Calibrate the process voltage input to 9.0 Volt (see "Calibrating the Series SD").	<input type="checkbox"/> no <input checked="" type="checkbox"/> YES	<input type="checkbox"/> no <input checked="" type="checkbox"/> YES	<input type="checkbox"/> no	*NA	Always active.
<input type="checkbox"/> R4 [A.4]	Input Calibrate, 4.0 mA Calibrate the process current input to 4.0 mA (see "Calibrating the Series SD").	<input type="checkbox"/> no <input checked="" type="checkbox"/> YES	<input type="checkbox"/> no <input checked="" type="checkbox"/> YES	<input type="checkbox"/> no	*NA	Always active.
<input type="checkbox"/> R16 [A.16]	Input Calibrate, 16.0 mA Calibrate the process current input to 16.0 mA (see "Calibrating the Series SD").	<input type="checkbox"/> no <input checked="" type="checkbox"/> YES	<input type="checkbox"/> no <input checked="" type="checkbox"/> YES	<input type="checkbox"/> no	*NA	Always active.
<input checked="" type="checkbox"/> O3.1v [O3.1v]	Output 3 Calibrate, 1.0 Volt The voltage process output transmits 1.000V (see "Calibrating the Series SD").	<input type="checkbox"/> no <input checked="" type="checkbox"/> YES	<input type="checkbox"/> no <input checked="" type="checkbox"/> YES	<input type="checkbox"/> no	*NA	The respective output is process.
<input checked="" type="checkbox"/> O3.9v [O3.9v]	Output 3 Calibrate, 9.0 Volt The voltage process output transmits 9.000 V (see "Calibrating the Series SD").	<input type="checkbox"/> no <input checked="" type="checkbox"/> YES	<input type="checkbox"/> no <input checked="" type="checkbox"/> YES	<input type="checkbox"/> no	*NA	The respective output is process.
<input checked="" type="checkbox"/> O3.4A [O3.4A]	Output 3 Calibrate, 4.0 mA The current process output transmits 4.000 mA (see "Calibrating the Series SD").	<input type="checkbox"/> no <input checked="" type="checkbox"/> YES	<input type="checkbox"/> no <input checked="" type="checkbox"/> YES	<input type="checkbox"/> no	*NA	The respective output is process.
<input checked="" type="checkbox"/> O3.16 [O3.16]	Output 3 Calibrate, 16.0 mA The current process output transmits 16.000 mA (see "Calibrating the Series SD").	<input type="checkbox"/> no <input checked="" type="checkbox"/> YES	<input type="checkbox"/> no <input checked="" type="checkbox"/> YES	<input type="checkbox"/> no	*NA	The respective output is process.

* The Series SD limit can be calibrated only with the front panel controls. These parameters are not visible through serial communications.

Calibrating the Series SD Limit

Warm up the unit for 20 minutes. To reach the calibration prompts, enter the Factory Page by holding down the Up Key **▲** and Down Key **▼** for six seconds. Once in the Factory Page [**FACT**], use the Advance **⊙** key to select a prompt. The last prompts on the Factory Page are the input and output calibration prompts.

You can restore the original factory calibration with Restore Factory Calibration [**RESET**] (Factory Page).

***Note: InfoSense™ should be turned off while verifying calibration of the controller with a calibration source.**

Thermocouple Input Procedure

Equipment

- Type J reference compensator with reference junction at 0°C (32°F), or type J thermocouple calibrator to 0°C (32°F).
- Precision millivolt source, 0 to 50 mV minimum range, 0.002 mV resolution.

Input Setup and Calibration

1. Connect the correct power supply to terminals 1 and 2 (see Chapter Two).
2. Connect the millivolt source to terminals 11 (-) and 10 (+) with copper wire.
3. Enter 50.00 mV from the millivolt source. Allow at least 10 seconds to stabilize. Set Thermocouple Calibration, 50 mV [**Ec.50**] to [**YES**]. Press the Advance Key **⊙** to store 50.000 mV input and move to the next prompt.
4. Enter 0.000 mV from the millivolt source. Allow at least 10 seconds to stabilize. Set Thermocouple Calibration, 0 mV [**Ec.00**] to [**YES**]. Press the Advance Key **⊙** to store 0.000 mV input and move to the next prompt.
5. Disconnect the millivolt source and connect the reference compensator or thermocouple calibrator to terminals 11 (-) and 10 (+). With type J thermocouple wire, if using a compensator, turn it on and short the input wires. When using a type J calibrator, set it to simulate 0°C (32°F). Allow 10 seconds for the controller to stabilize. Set Thermocouple Calibration, 32° [**Ec.32**] to [**YES**]. Press the Advance Key **⊙** to store type J thermocouple calibration and move to the next prompt.
6. Rewire for operation and verify calibration.

RTD Input Procedure

Equipment

- 1 kΩ decade box with 0.01Ω resolution.

Input Setup and Calibration

1. Connect the correct power supply to terminals 1 and 2 (see Chapter 2).
2. Connect the decade box to terminals 10 (S1), 11 (S3) and 8 (S2), with 20 to 24-gauge wire.
3. Enter 15.00Ω from the decade box. Allow at least 10 seconds to stabilize. Set RTD Calibration, 15Ω [**r.15**] to [**YES**]. Press the Advance Key **⊙** to store the 15.00Ω input and move to the next prompt.
4. Enter 380.00Ω from the decade box. Allow at least 10 seconds to stabilize. Set RTD Calibration, 380Ω [**r.380**] to [**YES**]. Press the Advance Key **⊙** to store the 380.00Ω input and move to the next prompt.
5. Rewire for operation and verify calibration.

Voltage Process Input Procedure

Equipment

- Precision voltage source, 0 to 10V minimum range, with 0.001V resolution.

Input Setup and Calibration



1. Connect the correct power supply to terminals 1 and 2 (see Chapter Two).
2. Connect the voltage source to terminals 11 (-) and 9 (+) of the controller.
3. Enter 1.00V from the voltage source to the controller. Allow at least 10 seconds to stabilize. Set Input Calibrate, 1V [**u.1**] to [**YES**]. Press the Advance Key **⊙** to store the 1.00V input and move to the next prompt.
4. Enter 9.00V from the voltage source to the controller. Allow at least 10 seconds to stabilize. Set Input Calibrate, 9V [**u.9**] to [**YES**]. Press the Advance Key **⊙** to store the 9.00V input and move to the next prompt.
5. Rewire for operation and verify calibration.

Current Process Input Procedure

Equipment

- Precision current source, 0 to 20 mA range, with 0.01 mA resolution.

Input Setup and Calibration

1. Connect the correct power supply to terminals 1 and 2 (see Chapter Two).
2. Connect the current source to terminals 11(-) and 8(+).
3. Enter 4.00 mA from the current source to the controller. Allow at least 10 seconds to stabilize. Set Input Calibrate, 4 mA to . Press the Advance Key  to store the 4 mA input and move to the next prompt.
4. Enter 16.00 mA from the current source to the controller. Allow at least 10 seconds to stabilize. Set Input Calibrate, 16 mA to . Press the Advance Key  to store the 16 mA input and move to the next prompt.
5. Rewire for operation and verify calibration.









Process Output 3 Setup and Calibration

Equipment









- Precision volt/ammeter with 3.5-digit resolution.

1. Connect the correct power supply to terminals 1 and 2 (see Chapter Two).





Volts

2. Connect the volt/ammeter to terminals 14 (-) and 13 (+).
3. At Output 3 Calibrate, 1V select and press the Advance Key . The voltage output value appears in the upper display. Press the Up  or Down Key  to adjust the upper display value to match the value from the volt/ammeter. The unit should stabilize within one second. Repeat until the volt/ammeter reads 1.00V, $\pm 0.1V$. Press the Advance Key  to store the value and move to the next prompt.
4. At Output 3 Calibrate, 9V select and press the Advance Key . The voltage output value appears in the upper display. Press the Up  or Down Key  to adjust the upper display value to match the value from the volt/ammeter. The unit should stabilize within one second. Repeat until the volt/ammeter reads 9.00V, $\pm 0.1V$. Press the Advance Key  to store the value and move to the next prompt.
5. Rewire for operation and verify calibration.

Milliamperes

6. Connect the volt/ammeter to terminals 12 (+) and 14 (-).
7. At Output 3 Calibrate, 4 mA select and press the Advance Key . The current output value appears in the upper display. Press the Up  or Down Key  to adjust the upper display value to match the value from the volt/ammeter. The unit should stabilize within one second. Repeat until the volt/ammeter reads 4.00 mA, $\pm 0.1mA$. Press the Advance Key  to store the value and move to the next prompt.
8. At Output 3 Calibrate, 16 mA select and press the Advance Key . The current output value appears in the upper display. Press the Up  or Down Key  to adjust the upper display value to match the value from the volt/ammeter. The unit should stabilize within one second. Repeat until the volt/ammeter reads 16.00 mA, $\pm 0.1 mA$. Press the Advance Key  to store the value and move to the next prompt.
9. Rewire for operation and verify calibration.

Restoring Factory Calibration

- Press the Up  and Down  keys together for six seconds until appears in the upper display and appears in the lower display.
- Press the Advance Key  to step through the parameters until the appears.
- Use the Up Key  to select in the upper display.
- Press the RESET Key to exit the Factory Page.

9

Features

Saving and Restoring User Settings	40
Operations Page	40
Inputs	
INFOSENSE™ Sensing	40
Calibration Offset	41
Filter Time Constant	41
Sensor Selection	41
Access Lockout	41
Set Point Low Limit and High Limit	42
Process Input High and Low Scale	42
High Range and Low Range	42
Alarms	42
Process Alarms	42
Alarm Set Points	43
Alarm Hysteresis	43
Alarm Latching	43
Alarm Silencing	43
Retransmit	43
Communications	43
Overview	43
Setting Up a Modbus Network	44
Infrared Data Communications	45
Troubleshooting	46
Error Messages	48

Saving and Restoring User Settings

Recording setup and operations parameter settings for future reference is very important. If you unintentionally change these, you will need to program the correct settings back into the controller to return the equipment to operational condition.

After you program the controller and verify proper operation, use **[USR5]** to save the settings into a special section of memory. If the settings in the controller are altered and you want to return the controller to the saved values, use **[USR]** to recall the saved settings. This version has two sets of user settings.

To save the Setup and Operations parameters:

1. Ensure all the settings that you want to store are already programmed into the Setup Page, Programming Page, and Operations parameters.
2. From the Home Page, press the Up **▲** and Down **▼** keys together for six seconds until **[FRCT]** appears in the upper display and **[PAGE]** appears in the lower display.
3. Press the Advance Key **⊗** to step through the prompts until the **[USR5]** prompt appears.
4. Use the Up Key **▲** to select **[SEET1]** or **[SEET2]** in the upper display.
5. Press the RESET Key to exit the Factory Page.

Note: Only perform the above procedure when you are sure that all the correct settings are programmed into the controller. Saving the settings overwrites any previously saved collection of settings. Be sure to document all the controller settings.

To restore a collection of saved settings:

1. Press the Up **▲** and Down **▼** keys together for six seconds until **[FRCT]** appears in the upper display and **[PAGE]** appears in the lower display.
2. Press the Advance Key **⊗** to step through the menu until the **[USR]** prompt appears.
3. Use the Up Key **▲** to select or **[SEET1]** or **[SEET2]** in the upper display.
4. Press the RESET Key to exit the Factory Page.

Operations Page

Watlow's patented user-defined menu system improves operational efficiency. The user-defined Operations Page provides you with a shortcut to monitor or change the parameter values that you use most often. You can go directly to the Operations Page from the Home Page by pressing the Advance Key **⊗**.

You can create your own Operations Page with as many as 16 of the active parameters from the list in the Keys and Displays chapter. When a parameter normally located in the Setup Page is placed in the Operations Page, it is accessible through both. If you change a parameter in the Operations Page, it is automatically changed in its original page. If you change a parameter in its original page it is automatically changed in the Operations Page.

The default parameters will automatically appear in the Operations Page.

To change the list of parameters in the Operations Page, hold down the RESET key, then press the Advance Key **⊗**, and hold both down for about six seconds. This will take you to the Programming Page.

Press the Advance Key **⊗** once to go to the first selection in the page. The parameter choices will appear in the top display and the selection number will appear in the bottom display. Use the Up **▲** or the Down **▼** key to change the selected parameter in the top display. If you do not want a parameter to appear for that location, select **[none]**. To change the other 15 selections, press the Advance Key **⊗** to select a place in the page, **[P1]** to **[P15]**, in the bottom display and use the Up **▲** or the Down **▼** key to change the parameter selected in the top display.

Changes made to the Operations Page will persist until changed by the operator or defaulted by full defaults or user defaults. User-defined parameters are not over-written by default parameters if those features become enabled. Only parameters supported by a controller's particular hardware configuration and programming settings will appear.

Inputs

INFOSENSE™ Temperature Sensing

Watlow's INFOSENSE™ feature can improve temperature sensing accuracy by 50%. Watlow's INFOSENSE™ thermocouples and RTD temperature sensors must be used together to achieve these results.

Each INFOSENSE™ “smart” sensor contains four numeric values that are programmed into the SD memory. These values characterize Watlow sensors, for the controller to provide greater accuracy.

Turn the INFOSENSE™ feature on or off with INFOSENSE™ Enable **[ISEN]** (Setup Page). Set the four numerical values supplied with Watlow's INFOSENSE™ in the **[ISP1]**, **[ISP2]**, **[ISP3]** and **[ISP4]** parameters.

Contact your Watlow salesperson or Watlow authorized distributor for the pricing and availability of Watlow INFOSENSE™ products.

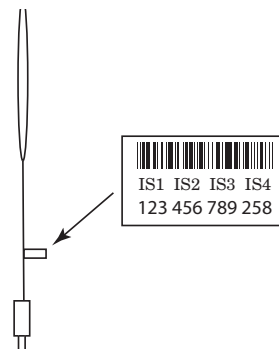

The four numerical values are found on the tag attached to the sensor.

Calibration Offset

Calibration offset allows a device to compensate for an inaccurate sensor, lead resistance or other factors that affect the input value. A positive offset increases the input value, and a negative offset decreases the input value.

The input offset value can be viewed or changed with Calibration Offset (Operations parameters).

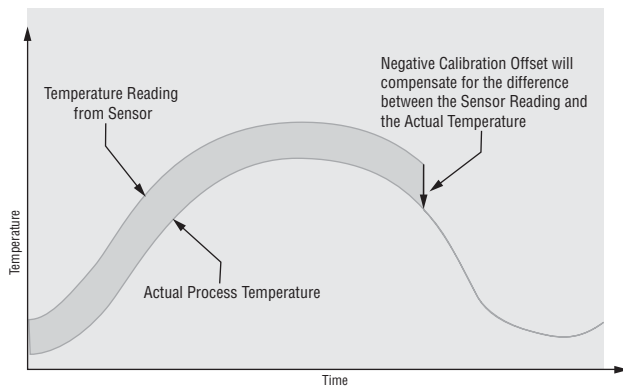

Filter Time Constant

Filtering smoothes an input signal by applying a first-order filter time constant to the signal. The displayed value, the controlled value or both the displayed and control values can be filtered. Filtering the displayed value makes it easier to monitor. Filtering the signal may improve the performance of the limit in a noisy or very dynamic system.

Select filter options with Input Filter . Select the Filter Value with (Setup Page).

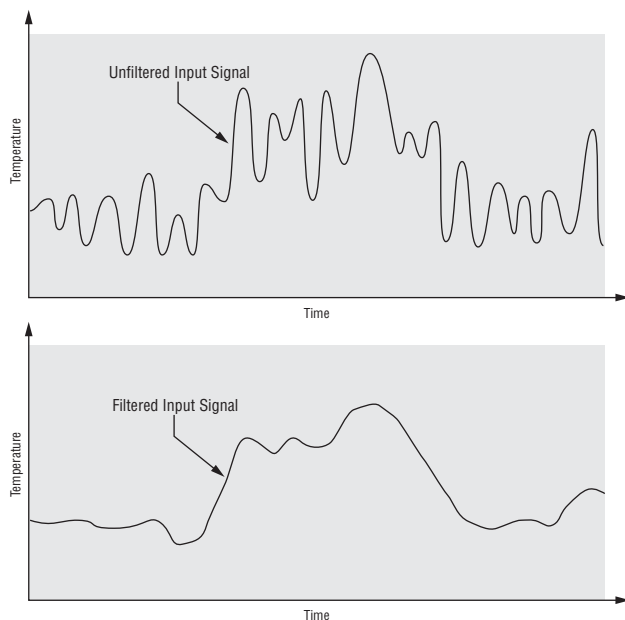

Sensor Selection

You need to configure the limit to match the input device, which is normally a thermocouple, RTD or process transmitter. When you select an input device, the limit automatically sets the input linearization to match the sensor. It also sets high and low limit values, which in turn determine the limit set point range-high and range-low values.

Select the sensor type with Sensor Type (Setup Page).

Access Lockout

The user's access to the Operations Page can be controlled through the parameter. The parameter appears at the end of the Setup Page. It does not affect the Setup, Factory or Programming Pages.

No level of lockout. The user has full access to all prompts and menus.

The Programming Page is locked from view. The Setup Page is locked except for the prompt, which can be viewed and changed. The user will be able to change and view all prompts in the Operation and Factory Pages.

The Programming Page is locked from view. The Setup Page will be locked except for the prompt, which can be viewed and changed. The user can change the limit low and limit high set points only. All prompts except for the and in the Operation Page are locked from view.

Full lockout of prompts and menus. All prompts in the Operation and Setup Pages are locked from view. The operator can use the Reset Key for clearing limits and alarms, and for silencing alarms. The operator can also use the and keys to access the prompt in the Setup Menu, which can be viewed and changed.

Note: For FM Approval, the parameter must be set to 3 or the limit must be mounted remotely to restrict casual user adjustment.

Set Point Low Limit and High Limit

The controller constrains the limit set point to a value between a low limit and a high limit. The high limit cannot be set higher than the sensor range high limit or lower than the sensor range low limit. The low limit cannot be set lower than the sensor range low limit or higher than the sensor range high limit.

Set the limit set point range with Set Point Low **[SPLo]** and Set Point High **[SPHi]** (Setup Page).

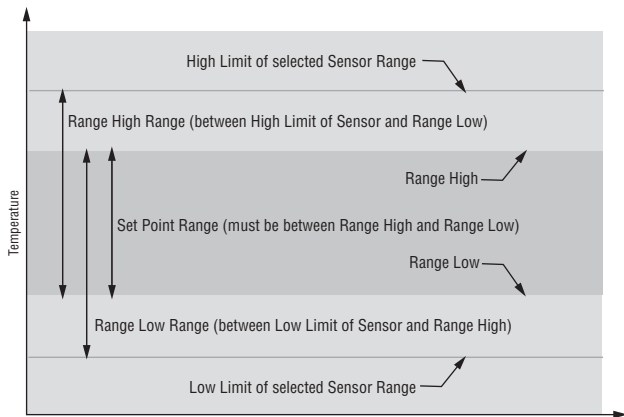

Process Input High and Low Scale

When an analog input is selected as a process voltage or process current input, you must choose the value of voltage or current to represent the low and high end values. For example, when using a 4 to 20 mA input, the scale low value would be 4.00 mA and the scale high value would be 20.00 mA. Commonly used scale ranges supported by the Series SD limit are: 4 to 20 mA and 1 to 5V. The maximum current scale is 20 mA and the maximum voltage scale is 10V. The minimum current scale is 4 mA and the minimum voltage scale is 1V. These minimum scale values allow the limit to detect a loss of the process input signal. The Series SD limit will not work with 0 to 20 mA, 0 to 5V or 0 to 10V process signals.

The Series SD limit allows you to create a scale range for special applications other than the standard ones listed above. Reversing of the scales from high values to low values is permitted for analog input signals that have a reversed action. For example, 50 psi = 4 mA and 10 psi = 20 mA.

Select the low and high values with Process Scale Low **[SCLo]** and Process Scale High **[SCHi]** (Setup Page).

High Range and Low Range

With a process input, you must choose a value to represent the low and high ends of the current or voltage range. Choosing these values allows the controller's display to be scaled into the actual working units of measurement. For example, the analog input from a humidity transmitter could represent 0 to 100 percent relative humidity as a process signal of 4 to 20 mA. Low scale would be set to 0 to represent 4 mA and high scale set to 100 to represent 20 mA. The indication on the display would then represent percent humidity and range from 0 to 100 percent with an input of 4 to 20 mA.

Select the low and high values with Units Scale Low **[rSLo]** and Units Scale High **[rShi]** (Setup Page).

Limits

Limit outputs are activated when the process value or temperature goes above the high limit set point or below the low limit set point. Limit outputs are always latching. The operator must press the RESET Key or cycle the input power to clear the limit condition once the process has returned to a safe condition. Configure limit outputs in the Setup Page before setting limit set points. Output 1 is always a limit output.

Limit Sides

Limit outputs can have a low limit set point, high limit set point or both low and high limit set points. For example, if the application only requires high limit protection, select high side active **[h,Sh]** for limit sides **[LSdI]** (Setup Page).

Alarms

Alarms are activated when the process value or temperature leaves a defined range. A user can configure how and when an alarm is triggered, what action it takes and whether it turns off automatically when the alarm condition is over.

Configure alarm outputs in the Setup Page before setting alarm set points.

Process Alarms

A process alarm uses one or two absolute set points to define an alarm condition.

Enable the process alarm type with the Setup Page parameters. View or change process alarm set points with the Operations Page parameters.

Alarm Set Points

The alarm high set point defines the process value or temperature that will trigger a high side alarm. It must be higher than the alarm low set point and lower than the high limit of the sensor range.

The alarm low set point defines the temperature that will trigger a low side alarm. It must be lower than the alarm high set point and higher than the low limit of the sensor range.

View or change alarm set points with the Operations Page parameters.

Limit or Alarm Hysteresis

A limit or alarm state is triggered when the process value reaches the limit or alarm high set point value or limit or alarm low set point. Hysteresis defines how far the process must return into the normal operating range before the limit or alarm output can be cleared.

Hysteresis is a zone inside each limit or alarm set point. This zone is defined by adding the hysteresis value to the low set point or subtracting the hysteresis value from the high set point.

View or change limit or alarm hysteresis for output 1, 2, or 3 Hysteresis, **[HYS1]**, **[HYS2]** or **[HYS3]** (Setup Page).

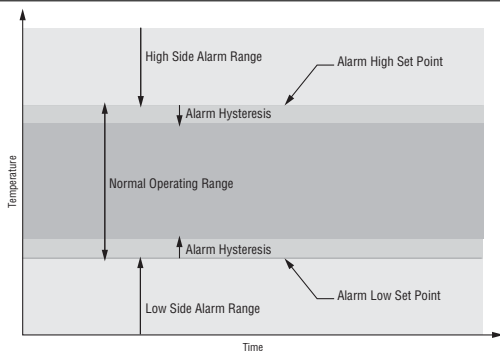

Alarm Latching

A latched alarm will remain active after the alarm condition has passed. To clear a latched alarm, press the RESET Key. It can only be deactivated by the user. An alarm that is not latched (self-clearing) will deactivate automatically when the alarm condition has passed.

Turn alarm latching on or off with Alarm 1, 2, or 3 Latching **[LAL1]**, **[LAL2]** or **[LAL3]** (Setup Page).

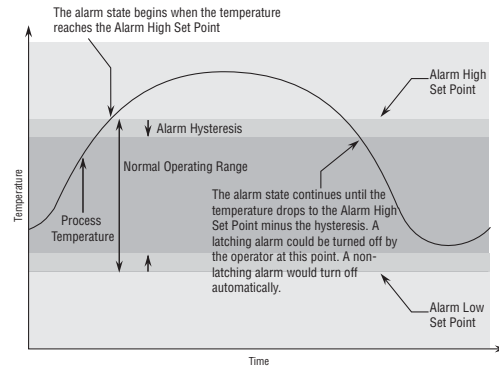

Alarm Silencing

Alarm silencing has two uses:

1. It is often used to allow a system to warm up after it has been started up. With alarm silencing on, an alarm is not triggered when the process temperature is initially lower than the alarm low set point. The process temperature has to enter the normal operating range beyond the hysteresis zone to activate the alarm function.
2. Alarm silencing also allows the operator to disable the alarm output while the controller is in an alarm state by pressing the RESET Key. The process temperature has to enter the normal operating range beyond the hysteresis zone to activate the alarm output function again.

Turn alarm silencing on or off with Alarm 2 or 3 Silencing **[SIL2]** or **[SIL3]** (Setup Page).

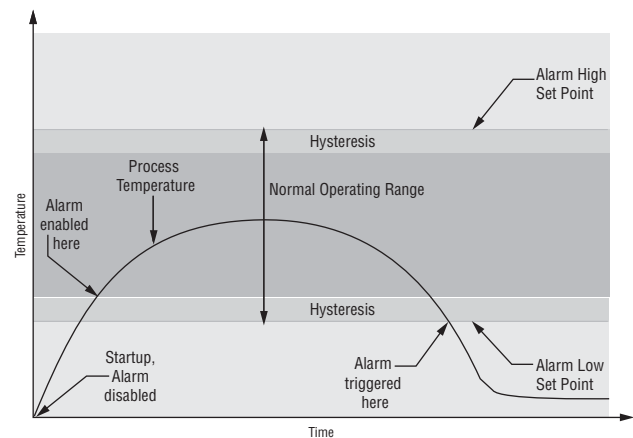

Retransmit

The retransmit feature allows a process output to provide an analog signal that represents the set point or actual process value. The signal may serve as a remote set point for another controller or as an input for a chart recorder to document system performance over time. Any process output can be configured as a retransmit output.

Communications

Overview

A Series SD controller can also be programmed and monitored by connecting it with a personal computer or programmable logic controller (PLC) via serial communications. To do this it must be equipped with an EIA/TIA 485 (SD__ - __ U_ - ____) communications option for Output 2. Your PC or PLC must have available an EIA/TIA-485 interface or use an EIA/TIA-232 to EIA/TIA-485 converter. See “Selecting an EIA/TIA-232 to EIA/TIA-485 converter” in Chapter 2. The EIA/TIA-485 option directly supports communication with up to 32 devices on a network or up to 247 devices using a 485 repeater.

To view or change controller settings with a personal computer, you need to run software that uses the Modbus RTU protocol to read or write to registers in the controller. See the parameter tables for information about the Modbus registers. These registers contain the parameter values that determine how the controller will function and current input and output values of the system. The address in the tables have been offset by subtracting 40,001 from each one.

Basic communications settings must first be configured on the controller in the Setup Page. Match the Baud Rate (**BAUD**) to that of the computer and select a unique Address (**Addr**) for each Series SD.

Setting Up a Modbus Network

1. Wire the controllers.

The Series SD uses an EIA/TIA-485 serial port, which is not typically found in a PC, but can be found on many PLC's. The type of port found in a typical PC is an EIA-232 port. Internal EIA/TIA-485 PC ports are available, but the most common way for a PC to communicate using a EIA-485 port is with an EIA/TIA-232 to EIA/TIA-485 converter.

The advantages of EIA/TIA-485 are that it is less susceptible to noise and it allows a PC or PLC to communicate with multiple controllers on the same port to form a network. It is important when using EIA/TIA-485, to install the termination resistors along with pull-up and pull-down resistors to ensure reliable communications.

Some newer PCs may only have a USB port. USB-to-serial adapters (usually EIA/TIA 232) are available from a variety of different PC vendors. Some companies offer adapters to convert from USB to EIA/TIA-485 directly.

2. Configure each controller's communications parameters in the Setup Menu using the front panel.

Only a couple of communications parameters need to be configured on the controller, Baud Rate and Modbus Address. The choices for Baud Rate are 9600 bps, 19200 bps or 38400 bps. 38400 baud allows for the fastest communication. For compatibility with other devices, reducing noise susceptibility, or increasing communications

distance, 9600 bps could be chosen. When using EIA/TIA-485, all devices connected to that port must use the same Baud Rate. The Modbus address is used to identify each controller on the network. With EIA/TIA-485, every controller on the network must have a unique address.

3. Choose a device to communicate with the controller.

The controller can communicate with devices, such as a computer running a software program, a PLC (Programmable Logic Controller) or an OIT (Operator Interface Terminal). Whichever device is chosen, it needs to be able to communicate using the Modbus RTU Protocol. OITs would need to be ordered with Modbus RTU support. PLCs would either have Modbus RTU as a standard feature or it can be made available with an I/O module. On a computer, the software package to be used would need to have the Modbus RTU capability.

4. Select a software package for the computer.

Select the software package based on what is required from the application. For basic communications (such as reading the process value or setting the set point), Watlow has the Comm6 software package. This is mainly used for diagnostics and basic communications.

When purchasing a third-party software package, be sure to look for a package that is Modbus RTU compatible or has Modbus RTU drivers. Most third-party packages require you to specify the Modbus registers of the controller to setup the package.

Another option is to custom-create a software package. Using the Modbus register and data information in this user's manual, a software package can be created and tailored to the desired application. To assist in application development, Watlow offers WATCONNECT™, which is a Windows-based software library for Modbus RTU communications. For further information on the WATCONNECT™ software library, or to download the Comm6 software, go to the Watlow web site at <http://www.watlow.com>.

5. Configure the software's communications parameters.

A software package, (be it software for a computer, a PLC or an OIT) will need to be configured just as the controller was configured, setting the Baud Rate and Address to match. The software package may have additional parameters to set, such as number of data bits, parity and stop bits. For Watlow controllers using modbus, these should always be set at 8 data bits, no parity, and 1 stop bit. This is often written as “8N1”. Some software packages may give the option to control the activity of the RTS, CTS and DTR lines, which are sometimes used by EIA-232 to EIA-485 converters. On packages where the Modbus registers for the controller need to be defined, these values can be entered at this time. Be sure to account for offsets.

6. Test the communications.

Once communications is configured, test the link to the controller for verification that everything is wired and configured properly. Check the wiring and configurations if things aren't working. One misplaced wire or one incorrect setting will keep communications from working. When using an EIA-232 to EIA-485 converter, be sure to follow the configuration instructions provided with the converter, as some may require special jumper/switch settings, external power supply requirements or special signals from the software. Some software packages have built-in routines for testing the communications or use Comm6 to help diagnose problems.

7. Start communications with the controller.

With the communications successfully verified, the software is now ready for use with the controller. The above guidelines are the general steps to establishing communications with controllers using Modbus. Some applications may require other steps not mentioned, but would follow the same general process.

8. Programming and configuring the controllers.

When programming and configuring the controllers with a software program, a couple of things must be kept in mind. If the software allows changing Setup parameters such as Input Type, other parameter values that are dependent on that setting may be automatically changed. Some software packages may warn you of this possibility and others may not.

Also, some controllers require that any changes made by the software program to controller parameters that need to be retained in the controller memory must be saved in the non-volatile memory writes register. Any settings not saved to controller memory will be lost when the controller's power is turned off.

Writing to Non-Volatile Memory

The Series SD stores parameter values in non-volatile EEPROM memory. This type of memory has a finite life of approximately 100,000 write cycles. In some applications, you might need to constantly write new values to a particular register. Examples might be the writing of limit or alarm set points through serial communications. Continuous writes may result in premature controller failure and system downtime.

To prevent premature failure of the EEPROM when frequently writing register values, write a 0 to register 17. Any values written after that, will not be stored to EEPROM. However, this data is lost when power is removed. Register 17 defaults to a value of 1 after each power cycle, writing values to EEPROM again. You must write a 0 to register 17 upon power up to prevent data from being written to EEPROM.

Infrared Data Communications (IDC)

Infrared Data Communications is an option available on the 1/16th, 1/8th and 1/4 Din Series SD products. This option supports wireless communications with PDAs (personal digital assistants) or other devices equipped with infrared communications that support the IrDA 1.0 Standard. IrDA is an acronym for the Infrared Data Association, www.irda.org. A PDA or other master device communicates with the SD Series using Modbus ASCII via IRCOMM over IrDA. IDC supports wireless communications through transparent material to a distance of no less than one meter between devices at a maximum angle of 15 Degrees.

IDC can support complete Series SD parameter configuration and operation. The actual user interface or configuration is dependent on the master device (PDA) application software. A source for this software is Instant HMI from Software Horizons. For more information, go to www.InstantHMI.com or call (978) 670-8700.

Advantages of this feature include automated logging of key process variables, increased accuracy and ease of use for recipe or configuration setups, and easier controller data exchange in physically restricting environments, such as semiconductor clean rooms. This feature reduces the use of paper to record instrument information as well as human transposition errors.

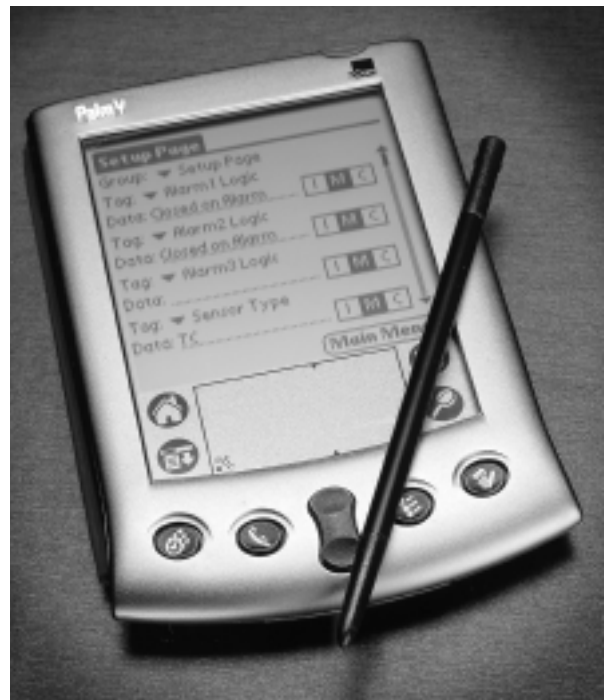

Troubleshooting

Indication	Probable Cause(s)	Corrective Action
<p>No power. Controller appears dead. No display indication in either window.</p>	<p>Power to unit may be off. Fuse may be blown. Breaker may be tripped. Safety interlock door switch, etc. may be activated. Separate system limit control may be latched. Wiring may be open. Input power may be incorrect.</p>	<p>Check switches, fuses, breakers, interlocks, limit devices, connectors, etc. for energized condition and proper connection. Measure power upstream for required level. Verify supply power requirements using the part number. Check wire size. Check for bad connections.</p>
<p>Cannot establish serial data communications with the controller.</p>	<p>Address parameter may be incorrectly set. Baud rate parameter may be incorrectly set. Unit-to-unit daisy chain may be disconnected. Communications wiring may be reversed, shorted or open. EIA-485 converter box may be incorrectly wired. Computer's COM port may be incorrectly set up. Communications software setup or address may be incorrect. PC software's protocol or parity may be wrong. Parity should be 8, n, 1. Application software is not working properly. May need termination, pull-up and pull-down resistors.</p>	<p>Check Setup Page and set to correct address. Check Setup Page and set to correct baud rate. Look for a break in the daisy chain. Verify correct connections and test wiring paths. Check converter box wiring and its documentation. Reconfigure computer's COM port setup and verify that communications are ok. Check the communication card documentation for settable variables and operational testing. Restart PC software and check for settings agreement. Verify the COM bus is active. Verify operation with Watlow communications tool available at www.watlow.com. Add termination resistors for EIA/TIA-485 (see Install and Wire chapter).</p>
<p>Cannot establish infrared communications link.</p>	<p>Optical transceiver path obstructed. Infrared device too far away. Infrared device software settings do not match controller's infrared settings.</p>	<p>Hold the infrared device within range and angle of view to the controller. Verify infrared settings.</p>
<p>Output signal is on when it should not be.</p>	<p>Output wiring is incorrect. Output parameters are set incorrectly. DC voltage applied to output option "K" (solid-state relay output).</p>	<p>Verify the output wiring. Verify the output parameter settings. Solid-state relay option can be used with alternating current (ac) voltage only.</p>
<p>Output signal is not on when it should be.</p>	<p>Output wiring is incorrect. For solid-state relay (option "K") and mechanical relay (option "E" or "J"), power must be applied. Output parameters are set incorrectly.</p>	<p>Verify the output wiring. Verify that power is applied to the output. The output simply acts as a switch. Verify the output parameter settings.</p>

Indication	Probable Cause(s)	Corrective Action
Getting limit message L1h , L2h , L3h , L1Lo , L2Lo or L3Lo .	The process value is beyond a limit set point.	Determine when limit messages will display and the proper response to a limit message.
Getting alarm message R2h or R3h , R2Lo or R3Lo .	The process value is beyond an alarm set point.	Determine when alarms messages will display and the proper response to an alarm message.
Limit or alarm is occurring when it should not.	Limit or alarm settings are incorrect.	Adjust the limit or alarm settings to be correct for the application.
	Input may be in an error condition.	See error messages.
	Limit or alarm may be latched.	Press the RESET Key to unlatch a limit or alarm.
Limit or alarm output indication is incorrect.	Limit or alarm settings are incorrect.	Adjust the limit or alarm settings to be correct for the application.
	Alarm may be silenced.	See the Features Chapter for information on alarm silencing.
Limit or alarm is not occurring when it should.	Limit or alarm settings are incorrect.	Adjust the limit or alarm settings to be correct for the application.
Controller's process value reading is decreasing but actual process is increasing.	Thermocouple polarity is reversed.	Check thermocouple connections. All thermocouple connections, including thermocouple extension wire, must maintain the correct polarity for proper operation.
	Analog voltage or analog current input scaling is reversed or incorrect.	Check the settings of the analog output scale low and scale high parameter (Setup Page).
Parameter(s) do not appear.	Parameter is not active.	See Setup and Operation chapters to determine when parameters should appear.
	Parameter lockout is active.	Set the correct level of lockout for access (Setup Page).
	Operations Page is not configured properly.	Select the desired parameters for the Programming Page.
Cannot access Operation Page. Cannot change the limit or alarm-set point.	Parameter lockout is active.	Set the correct level of lockout* for access (Setup Page).

* Note: For FM Approval, the **LOC** parameter must be set to 3 or the limit must be mounted remotely to restrict casual user adjustment.

Error Messages

Indication	Probable Cause(s)	Corrective Action
Er.In Input error	<p>The sensor may be improperly wired. Sensor wiring may be reversed, shorted or open.</p> <p>The input may be set to the wrong sensor or the controller may not be calibrated. Calibration may have been corrupted.</p>	<p>Check sensor connections.</p> <p>Check sensor connections and sensor wiring.</p> <p>Change Sensor Type SEn (Setup Page) to match the sensor hardware.</p> <p>Restore factory calibration.</p>
Er.Ab Ambient temperature error	<p>Ambient temperature may be too hot or too cold.</p> <p>Calibration may be corrupted.</p>	<p>Verify that the temperature surrounding the controller is 0 to 65°C (32 to 149°F).</p> <p>Restore factory calibration.</p>
Er.CS Checksum error	<p>Settings may have changed unexpectedly.</p>	<p>Press the Reset Key to clear the error.</p> <p>Verify settings. If error message persists, contact the factory.</p>

A

Appendix

Specifications

Controller

- Microprocessor-based, user-programmable
- 1 Universal input, 3 outputs (2 outputs on 1/32 DIN)
- Output 1, latching mechanical relay limit output
- Display update: 10 Hz, adjustable digital filter
- Communication output isolated
- Displayed in °C, °F or process units

Operator Interface

- Dual 4-digit LED displays
- Advance, Up Arrow, Down Arrow, RESET (Home) tactile keys

Standard Conditions For Specifications

- Ambient temperature 25°C (77°F) ±3°C, rated line voltage, 50 to 60Hz, 0 to 90% RH non-condensing, 15-minute warm-up

Universal Input

- Sampling rate: 6.5 Hz

Thermocouple

- Type J, K, T, N, C (W5), E, PTII (F), D (W3), B, R, S thermocouple types. Whole or tenth of a degree resolution.
- >20 MΩ input impedance
- Maximum 20 Ω source resistance

RTD

- 2- or 3-wire platinum, 100 Ω
- DIN curve (.00385 curve)
- Whole or tenth degree indication
- 390 μA nominal RTD excitation current

Process

- Range selectable: 1 to 10V[≠] (dc), 1 to 5V[≠] (dc), 4 to 20 mA. (Can reverse low and high values.)
- Voltage input impedance 20 kΩ
- Current input impedance 100 Ω
- Minimum current source resistance 1 MΩ
- Input resolution 50,000 bits (approximately) at full scale

Input Accuracy

Input ranges

Type J:	32 to	1,382°F	or	0 to	750°C
Type K:	-328 to	2,282°F	or	-200 to	1,250°C
Type T:	-328 to	662°F	or	-200 to	350°C
Type N:	32 to	2,282°F	or	0 to	1,250°C
Type E:	-328 to	1,470°F	or	-200 to	900°C
Type C (W5):	32 to	4,200°F	or	0 to	2,315°C
Type D (W3):	32 to	4,200°F	or	0 to	2,315°C
Type PTII (F):	32 to	2,540°F	or	0 to	1,393°C
Type R:	32 to	2,642°F	or	0 to	1,450°C
Type S:	32 to	2,642°F	or	0 to	1,450°C
Type B:	1,598 to	3,092°F	or	870 to	1,700°C
RTD:	-328 to	1,472°F	or	-200 to	800°C
Process:	-1,999 to	9,999 unit:			

Allowable Operating Ranges

Type J:	32 to	1,500°F	or	0 to	815°C
Type K:	-454 to	2,500°F	or	-270 to	1,370°C
Type T:	-454 to	750°F	or	-270 to	400°C
Type N:	32 to	2,372°F	or	0 to	1,300°C
Type E:	-454 to	1,470°F	or	-270 to	800°C
Type C:	32 to	4,200°F	or	0 to	2,315°C
Type D:	32 to	4,200°F	or	0 to	2,315°C
Type PTII (F):	32 to	2,543°F	or	0 to	1,395°C
Type R:	32 to	3,200°F	or	0 to	1,760°C
Type S:	32 to	3,200°F	or	0 to	1,760°C
Type B:	32 to	3,300°F	or	0 to	1,816°C
DIN	-328 to	1,472°F	or	-200 to	800°C
Process	-1,999 to	9,999 ur			

Thermocouple Input

- Calibration accuracy: ±0.1% of input span ±1°C at standard conditions
- Temperature stability: ±0.2 degree per degree change in ambient for J, K, T, N, E, F
±0.3% for C and D
±0.4% for B, R (excluding 0 to 100°C) and S (excluding 0 to 100°C)
±0.5% for R and S (entire input accuracy range)

RTD Input

- Calibration accuracy ±0.1% of input range ±1°C at standard conditions
- Temperature stability: ±0.05 degree per degree change in ambient

Process Input

- Voltage input ranges
Accuracy ±10mV ±1 LSD at standard conditions
Temperature stability ±100 ppm/°C maximum
- Milliamp input ranges
Accuracy ±20μA ±1 LSD at standard conditions
Temperature stability ±100 ppm/°C maximum

Output Types

Open Collector

- Maximum voltage: 42V[≠] (dc)
- Maximum current: 250 mA
- Class 2 power source required

Switched DC

- Supply voltage minimum: 6V[≠] (dc) @ 30 mA
- Supply voltage maximum: 12V[≠] (dc) into an infinite load

Solid-state Relay

- Optically isolated
- Zero cross switched
- Without contact suppression
- Minimum load current: 10 mA rms
- Maximum current: 0.5A rms at 24 to 240V~ (ac), resistive
- Maximum offstate leakage current: 100 μA rms
- For resistive loads only, must use RC suppression for inductive loads
- 20 VA pilot duty, 120/240V~ (ac)
- Electrical life 100,000 cycles at rated current

Electromechanical Relay, Form A

- Minimum load current: 10 mA
- Rated resistive: 2 A @ 240V~ (ac) or 30V= (dc) maximum
- Electrical life 100,000 cycles at rated current
- For resistive loads only, must use RC suppression for inductive loads
- 125 VA pilot duty, 120/240V~ (ac)

Electromechanical Relay, Form C

- Minimum load current: 10 mA
- Rated resistive: 5 A @ 240V~ (ac) or 30V= (dc) maximum
- Electrical life 100,000 cycles at rated current
- For resistive loads only, must use RC suppression for inductive loads
- 125 VA pilot duty, 120/240V~ (ac)

Process

- Range selectable: 0 to 20 mA, 4 to 20 mA, 0 to 5V= (dc), 1 to 5V= (dc), 0 to 10V= (dc)
- Reverse or direct acting
- 0 to 10V= (dc) voltage output into 1,000 Ω minimum load resistance
- 0 to 20 mA current output into 800 Ω maximum load resistance
- Resolution:
 - dc ranges: 2.5 mV nominal
 - mA ranges: 5 µA nominal
- Calibration accuracy:
 - dc ranges: ±15 mV
 - mA ranges: ±30 µA
- Temperature stability: 100 ppm/°C

Communications

EIA/TIA-485

- Isolated
- Modbus™ RTU protocol
- 9600, 19200 and 38400 baud rates
- A maximum of 32 units can be connected (with additional 485 repeater hardware, up to 247 units may be connected)
- Sampling rate: 20 Hz
- Modbus™ is a trademark of AEG Schneider Automation.

IrDA

- Modbus™ RTU via IRCOMM over IrDA
- Sampling rate: 20 Hz

Agency Approvals

- Factory Mutual Class 3545, Temperature Limit Switches. File #3014848.
- UL Listed Process Control UL3121® (UL 61010C-1), c-UL, CE, IP65 (NEMA 4X), NEMA 12. File # E185611.
UL® is a registered trademark of the Underwriter's Laboratories, Inc.
- CSA C22.2#24 Temperature Indicating and Regulating Equipment. File LR30586.
- NSF2 (National Sanitation Foundation) for calibration accuracy with J, K, E, T, or RTD sensors. File 49660-0002-0001

Terminals

- Touch-safe
- Input power and control outputs: 12 to 22 AWG, 6 mm (0.25 in) strip length
- Sensor inputs and process outputs: 20 to 28 AWG, 8 mm (0.30 in) strip length
- Torque: terminal blocks 1 to 6 (SD __ - _ [C, K or J] __ - _ _ _ _) and 1 to 4 (SD __ - _ F __ - _ _ _ _) are 0.8. Nm (7 in-lb); terminal blocks 12, 13, 14 are 0.9 Nm (8 in-lb).
- Solid or tinned wire recommended.

Power

- 100 to 240V~ (ac) +10%; -15%; 50/60 Hz, ±5%
- 24V= (ac/dc) +10%; -15%; 50/60 Hz, ±5%; Class 2 power source is required for low-voltage model.
- 10VA maximum power consumption
- Data retention upon power failure via nonvolatile memory

Operating Environment

- -18 to 65°C (0 to 149°F)
- 0 to 90% RH, non-condensing
- Storage temperature: -40 to 85°C (-40 to 185°F)

Dimensions

DIN Size	Behind Panel (max.)	Width	Height
1/32	97.8 mm (3.85 in)	52.6 mm (2.07 in)	29.7 mm (1.17 in)
1/16	97.8 mm (3.85 in)	52.1 mm (2.05 in)	52.1 mm (2.05 in)
1/8 Vertical	97.8 mm (3.85 in)	52.8 mm (2.08 in)	99.8 mm (3.93 in)
1/8 Horizontal	97.8 mm (3.85 in)	99.8 mm (3.93 in)	52.8 mm (2.08 in)
1/4	101.1 mm (3.98 in)	99.8 mm (3.93 in)	99.8 mm (3.93 in)

Functionality Matrix

	Universal Input	Limit	Alarm	Process	485 Comm
Input 1	■				
Output 1		■			
Output 2		■	■		■
Output 3		■	■	■	

Note: These specifications are subject to change without prior notice.

Ordering Information and Model Numbers

		S	D	L	—	J	—	A	
DIN Sizes	3, 6, 8, 9 or 4								
3	1/32 DIN								
6	1/16 DIN								
8	1/8 DIN Vertical								
9	1/8 DIN Horizontal								
4	1/4 DIN								
Control Type	L*								
L	Limit Control								
Power Supply	H or L								
H	100 to 240V~ (ac)								
L	24V~ (ac/dc)								
Output 1	J								
J	Mechanical Relay Form A, 2 Amp								
Output 2	A, C, K, J or U								
A	None								
C	Switched DC								
K	Solid-state Relay Form A, 0.5 Amp								
J	Mechanical Relay Form A, 2 Amp								
U	EIA/TIA-485 Modbus Communications								
Output 3 (not available on 1/32 DIN)	A, C, K, F or E								
A	None								
C	Switched DC/Open Collector								
K	Solid-state Relay Form A, 0.5 Amp								
F	Universal Process								
E	Mechanical Relay Form C, 5 Amp								
Infrared comms options	A or R								
A	None								
R	Infrared Communications Ready (not availat								
Display Colors and Custom options	RG or RR								
RG	Red Green								
RR	Red Red (Not available on 1/32 DIN)								

*UL-approved PID control and PID profiling versions are available. For more information, go to www.watlow.com or contact your local Watlow representative.

Index

- Access Lockout 41
- Active Output Indicator Lights 19
- Address 44
- Adjusting the limit set point value 20
- Advance Key 19
- Agency Approvals 50
- Alarm 2 High 30
- Alarm 2 Latching 26
- Alarm 2 Low 30
- Alarm 2 Message 26
- Alarm 2 Silencing 26
- Alarm 3 High 30
- Alarm 3 Latching 27
- Alarm 3 Low 30
- Alarm 3 Message 27
- Alarm 3 Silencing 27
- Alarm High 2 Status 23
- Alarm High 3 Status 23
- Alarm Latching 43
- Alarm Low 2 Status 23
- Alarm Low 3 Status 23
- Alarm Message 20
- Alarm Set Points 42
- Alarm Silencing 43
- Alarms 42
- Ambient Temperature 36
- Analog Output 3 Scale High 27
- Analog Output 3 Scale Low 27
- Analog Output 3 Units 27
- Appendix 49
- Automatic send data control 17
- Back Views 10
- Baud Rate 29, 44
- Biasing and termination 17
- Calibration Offset 25, 31, 41
- Comm6 44
- Communications 42, 50
- Current Process Input Cal Procedure 40
 - data bits 44
- Default Parameters, Programming Page 32
- Dimensions 4, 50
 - 1/16 DIN 4
 - 1/32 DIN 4
 - 1/4 DIN 5
 - 1/8 DIN 5
- Display Intensity 36
- EIA/TIA 232 to 485 converter 17
- EIA/TIA-232 to EIA/TIA-485 converter 44
- EIA/TIA-485 50
- Error condition 20
- Error Messages 48
- Factory Page and Calibration 36
- Factory Page Overview 22
- Features 39
- Filter Time Constant 41
- Filter Value 25
- Filtered Process Value 23
- Functionality Matrix 50
- Ground loops 11
- Home Page 23
- Home Page Overview 20
- How to use 3
- INFOSENSE™ 2, 24, 40
- Infrared Data Communications 45
- Input accuracy ranges 49
- Input Calibrate, 1.0 Volt 35
- Input Calibrate, 16.0 mA 36
- Input Calibrate, 4.0 mA 36
- Input Calibrate, 9.0 Volt 36
- Input Error 23
- Input Error Latching 27
- Input Filter 25
- Inputs 40
- Inputs and outputs 2
- Install and Wire 4
- Installation 6
 - 1/16 DIN 7
 - 1/32 DIN 6
 - 1/4 DIN 9
 - 1/8 DIN 8
- Instant HMI 45
- IP65/NEMA 4X seal 6
- IrDA 45
- Isolation 17
- Isolation Blocks 11
- Keys and Displays 19
- Left Display 19
- Limit 1 High 30
- Limit 1 High Set Point 23
- Limit 1 Hysteresis 26, 31
- Limit 1 Low 30
- Limit 2 High 30
- Limit 2 Low 30
- Limit 3 High 30
- Limit 3 Low 30
- Limit High 1 Status 23
- Limit High 2 Status 23
- Limit High 3 Status 23
- Limit Low 1 Status 23
- Limit Low 2 Status 23
- Limit Low 3 Status 23
- Limit or Alarm Hysteresis 43
- Limit Tripped Operation 20
- Lockout 29
- Lockout for FM Approval 21, 29, 41
- Lower Display 19
- Lower Display Look 28
- Maximum Recorded Ambient Temp. 32
- Minimum Recorded Ambient Temp. 32
- Modbus 44
- Modbus Device Address 29, 31
- Modbus RTU Protocol 44
- Model Number information 51
- National Electric (NEC) 11
- Operating Environment 50
- Operating Ranges 49
- Operations Page 40
- Operations Page Overview 20
- Operations Parameters Table 30
- Ordering Information 51
- Output 1 Function 25
- Output 1 Limit Sides 25
- Output 1 Type 34
- Output 2 Function 26
- Output 2 Hysteresis 26, 31
- Output 2 Logic 26
- Output 2 Sides 26
- Output 2 Type 35
- Output 3 Calibrate, 1.0 Volt 36
- Output 3 Calibrate, 16.0 mA 36
- Output 3 Calibrate, 4.0 mA 36
- Output 3 Calibrate, 9.0 Volt 36
- Output 3 Function 26
- Output 3 Hysteresis 27, 31
- Output 3 Logic 27
- Output 3 Process Value 34
- Output 3 Sides 26
- Output 3 Type 35
- Output Types 48
- Overview 2
- Parity 44
- PDA software 45
- PID controller 3, 51
- Power 50
- Power Supply 17
- Power Type 35
- Process Alarms 42
- Process Decimal Places 24
- Process Output 3 Cal Procedure 38
- Process Scale High 25
- Process Scale Low 25
- Process Value 23
- Programming Page Overview 22
- Quencharc 13
- R.C. suppressor 13
- Removal 6
 - 1/16 DIN 7
 - 1/32 DIN 6
 - 1/4 DIN 9
 - 1/8 DIN 8
- RESET Key 19
- Restore Factory Calibration 34
- Restore User Settings 34
- Restoring Factory Calibration 38
- Right Display 19
- RTD Input Cal Procedure 37
- RTD, 15 ohm 35
- RTD, 380 ohm 35
- Sampling rate 49
- Save User Settings 34
- Saving and Restoring User Settings 40

Sensor Selection 41
Sensor Type 24
Serial Number 1 35
Serial Number 2 35
Set Point High Limit 25, 42
Set Point Low Limit 25, 42
Setting Up a Modbus Network 44
Setup Page 24
Setup Page Overview 21
Software Build Number 35
Software ID 35
Software Version 35
Specifications 49
stop bit 44
Temperature Decimal Places 24
Temperature Units 24, 31
Terminals 50
Thermocouple Input Cal Procedure 37
Thermocouple Linearization 24
Thermocouple, 0mV 35
Thermocouple, 32°F 35
Thermocouple, 50mV 35
Troubleshooting 46
Units Scale High 25
Units Scale Low 25
Up and Down Keys 19
Upper Display 19
Upper Display Look 28
Voltage Process Input Cal Procedure 37
WATCONNECT™ 44
Watlow web site 44
Wiring 11
 1 to 10V \bar{I} Process Input 12
 4 to 20 mA Process Input 13
 485 Converter 17
 High Voltage AC Power Wiring 11
 Low Voltage AC Power Wiring 11
 Output 1 Mechanical Relay 13
 Output 2 EIA/TIA-485 14
 Output 2 Mechanical Relay 13
 Output 2 Solid-state Relay 14
 Output 2 Switched DC 14
 Output 3 Mechanical Relay 15
 Output 3 Open Collector 16
 Output 3 Process 16
 Output 3 Solid-state Relay 15
 Output 3 Switched DC 15
 RTD Input 12
 Thermocouple Input 12

Prompt Index

A4	22, 36	O39u	22, 36
A.16	22, 36	O3h ,	21, 27
A2h ,	20, 22, 23, 30	O3Lo	21, 27
A2Lo	20, 22, 23, 30	Ot41	22, 34
A3h ,	20, 22, 23, 30	Ot42	22, 34
A3Lo	20, 22, 23, 30	Ot43	22, 34
AP7A	22, 34	Ot 1	21, 25
AP7n	22, 34	Ot 2	21, 26
AOt3	22, 34	Ot 3	21, 26
Addr	21, 22, 29, 31	PdEC	21, 24
AP7b	22, 34	Pro9	22
AO3U	21, 27	PLJr	22, 35
bAud	21, 29	r.15	22, 35
CAL	21, 22, 25, 31	r.380	22, 35
C-F	21, 22, 24, 31	rESE	22, 32, 38
dFLt	22, 34	r9h ,	21, 25
dSP2	21, 26	r9Lo	21, 25
dSP3	21, 27	SbLd	22, 35
dSPL	22, 34	SdEC	21, 24
ErAb	20, 23	SUER	22, 35
ErCS	20, 23	Sc.h ,	21, 25
Er.In	20, 23	Sc.Lo	21, 25
FRct	22, 34	SEn	21, 24
FLt.r	21, 25	SEt	24
Ft.r.E	21, 25	S.id	22, 35
h4S1	21, 22, 26, 31	S.L2	21, 26
h4S2	21, 22, 26, 31	S.L3	21, 27
h4S3	21, 22, 27, 31	Sn-	22, 35
IErr	21, 27	Sn_	22, 35
ISEn	21, 24	SP.h ,	21, 25
ISP1	21, 24	SP.Lo	21, 25
ISP2	21, 24	tc.00	22, 35
ISP3	21, 24	tc.32	22, 35
ISP4	21, 24	tc.50	22, 35
L1h ,	20, 22, 23, 30	U.1	22, 35
L1Lo	20, 22, 23, 30	U9	22, 36
L2h ,	20, 22, 23, 30	UdSP	21, 28
L2Lo	20, 22, 23, 30	USr.r	22, 34
L3h ,	20, 22, 23, 30	USr.S	22, 34
L3Lo	20, 22, 23, 30		
LAE2	21, 26		
LAE3	21, 27		
LdSP	21, 28		
L9c2	21, 26		
L9c3	21, 27		
L.in	21, 24		
LOC	21, 29		
LSd1	21, 25		
LSd2	21, 26		
LSd3	21, 26		
O3.16	22, 36		
O3.1u	22, 36		
O34A	22, 36		

Notes

Notes

Declaration of Conformity

Series SD

Watlow Winona, Inc.
1241 Bundy Blvd.
Winona, MN 55987 USA

Declares that the following product:

Designation: **Series SD**
Model Numbers: SD(3, 4, 6, 8 or 9) (C or L) – (H or L) (C, F, J or K)(A, C, J, K or U) (A, C, E, F or K) – (A or R)(any three letters or numbers)
Classification: Temperature control, Installation Category II, Pollution degree 2
Rated Voltage: 100 to 240V \hat{A} (ac) or 24V \ddagger (ac or dc) Rated Frequency: 50 or 60 Hz
Rated Power Consumption: 10VA maximum

Meets the essential requirements of the following European Union Directives by using the relevant standards shown below to indicate compliance.

89/336/EEC Electromagnetic Compatibility Directive

EN 61326: 1997 With A1:1998: Electrical equipment for measurement, control and laboratory use – EMC requirements (Industrial Immunity, Class B Emissions).
A2:2002:

EN 61000-4-2: 1996 With A1, 1998: Electrostatic Discharge Immunity
EN 61000-4-3: 1997: Radiated Field Immunity
EN 61000-4-4: 1995: Electrical Fast-Transient / Burst Immunity
EN 61000-4-5: 1995 With A1, 1996: Surge Immunity
EN 61000-4-6: 1996: Conducted Immunity
EN 61000-4-11: 1994: Voltage Dips, Short Interruptions and Voltage Variations Immunity
EN 61000-3-2: ED.2. 2000: Harmonic Current Emissions
EN 61000-3-3: 1995 With A1:1998: Voltage Fluctuations and Flicker

73/23/EEC Low-Voltage Directive

EN 61010-1: 1993 With A1: 1995 Safety Requirements of electrical equipment for measurement, control and laboratory use. Part 1: General requirements

Raymond D. Feller III

Name of Authorized Representative

Winona, Minnesota, USA

Place of Issue

General Manager

Title of Authorized Representative

November 2004

Date of Issue



Signature of Authorized Representative

How to Reach Us

**TOTAL
CUSTOMER
SATISFACTION**
3 Year Warranty

Your Authorized Watlow Distributor:

Corporate Headquarters in the U.S.:

Watlow Electric Manufacturing Co.
12001 Lackland Road
St. Louis, Missouri, USA 63146
Telephone: +1 (314) 878-4600
Fax: +1 (314) 878-6814

Europe:

Watlow GmbH
Industriegebiet Heidig
Lauchwasenstr. 1, Postfach 1165
Kronau 76709 Germany
Telephone: +49 (0) 7253-9400 0
Fax: +49 (0) 7253-9400-44

Watlow France S.A.R.L.
Immeuble Somag, 16 Rue Ampère,
Cergy Pontoise CEDEX 95307 France
Telephone: +33 (1) 3073-2425
Fax: +33 (1) 3073-2875

Watlow Italy S.R.L.
Via Meucci 14,
20094 Corsico MI
Italy
Telephone: +39 (02) 4588841
Fax: +39 (02) 458-69954

Watlow Limited
Robey Close, Linby Industrial Estate,
Linby Nottingham England, NG15 8AA
Telephone: +44 (0) 115 9640777
Fax: +44 (0) 115 9640071

Latin America:

Watlow de México
Av. Fundación #5,
Col. Parques Industriales,
Querétaro, Qro. México CP-76130
Telephone: +52 (442) 217-6235
Fax: +52 (442) 217-6403

Asia/Pacific:

Watlow Australia Pty., Ltd.
23 Gladstone Park Drive,
Tullamarine, Victoria 3043 Australia
Telephone: +61 (39) 335-6449
Fax: +61 (39) 330-3566

Watlow China, Inc.
179, Zhong Shan Xi Road
Hong Qiao Cointek Bldg, Fl. 4, Unit P
Shanghai 200051 China
Telephone: +86 (21) 6229-8917
Fax: +86 (21) 6228-4654

Watlow Japan Ltd. K.K.
Azabu Embassy Heights 106,
1-11-12 Akasaka,
Minato-ku, Tokyo 107-0052 Japan
Telephone: +81 (03) 5403-4688
Fax: +81 (03) 5403-4646

Watlow Korea Co., Ltd.
Hanil Bldg., 3rd Floor
210-5 Yangje-Dong Seocho-Gu
Seoul, 137-130 Korea
Telephone: +82 (2) 575-9804
Fax: +82 (2) 575-9831

Watlow Malaysia Sdn Bhd
38B Jalan Tun Dr Awang
11900 Bayan Lepas
Penang Malaysia
Telephone: +60 (4) 641-5977
Fax: +60 (4) 641-5979

Watlow Singapore Pte. Ltd.
Ayer Rajah Crescent
#03-23, Ayer Rajah Industrial Estate
Singapore 139949
Telephone: +65 773 9488
Fax: +65 778 0323

Watlow Electric Taiwan
10F-1 No. 189
Chi-Shen 2nd Road,
Kaohsiung, Taiwan
Telephone: +886 (7) 288-5168
Fax: +886 (7) 288-5568