

# Table of Contents

## General Information

Think Safety .....	3
--------------------	---

## Sensors

<b>Table of Contents</b> .....	<b>5</b>
<b>Product Selection Guide</b> .....	<b>6</b>
<b>Tolerances</b> .....	<b>14</b>
<b>Lab Services</b> .....	<b>16</b>
<b>Thermocouples</b> .....	<b>23</b>
General Information .....	25
General Applications Tube and Wire.....	32
Mineral Insulated (MI).....	52
EXACTSENSE® .....	64
Base Metal .....	67
High Temperature.....	71
MICROCOIL™.....	78
Radio Frequency .....	80
TRUE SURFACE (TST) .....	82
Multipoints.....	84
<b>Resistance Temperature Sensors</b> .....	<b>87</b>
Resistance Temperature Detectors (RTDs) .....	88
Thermistors .....	99
ENVIROSEAL™ HD.....	106
<b>Accessories</b> .....	<b>109</b>
Fittings.....	111
Thermowells .....	115
Protection Tubes .....	121
Connectors.....	125
Connection Heads and Blocks .....	132
Transmitters .....	134
<b>SERV-RITE® Wire</b> .....	<b>141</b>
General Information .....	142
Thermocouple and Extension Wire .....	143
RTD Lead Wire.....	178
<b>Mineral Insulated Cable</b> .....	<b>181</b>
XACTPAK® Cable.....	183

## Controllers

<b>Table of Contents</b> .....	<b>197</b>
<b>Product Selection Guide</b> .....	<b>198</b>
<b>Output Comparison Guide</b> .....	<b>207</b>
<b>Integrated Multi-Function</b> .....	<b>209</b>
F4T with INTUITION® .....	211
EZ-ZONE® RM .....	222
EZ-ZONE RMZ/RMF.....	240
EZ-ZONE ST .....	242
EZ-ZONE PM .....	249
EZ-ZONE PM Express.....	258
SERIES EHG® SL10.....	262
SERIES EHG .....	266
<b>Temperature and Process</b> .....	<b>269</b>
F4T with INTUITION.....	271
EZ-ZONE RM .....	272
EZ-ZONE RMZ/RMF .....	273
EZ-ZONE ST .....	274
SERIES F4 Ramping.....	275
SERIES F4 Process .....	281
EZ-ZONE PM .....	286
EZ-ZONE PM Express .....	287
SERIES CV .....	288
SERIES CF .....	291
SERIES EHG SL10.....	294
SERIES EHG .....	295
<b>Limits and Scanners</b> .....	<b>297</b>
F4T with INTUITION.....	299
EZ-ZONE RM High-Density Limit.....	300
EZ-ZONE RM High-Density Scanner .....	302
EZ-ZONE PM Limit .....	304
EZ-ZONE PM Express Limit.....	310
SERIES LV .....	314
SERIES LF.....	317
SERIES LS .....	320
TLM SERIES.....	322

# Table of Contents

## Controllers (Continued)

<b>Power Switching Devices</b> .....	<b>325</b>
Comparison Guide .....	326
EZ-ZONE ST .....	327
DIN-A-MITE® A.....	328
DIN-A-MITE B.....	331
DIN-A-MITE C .....	334
DIN-A-MITE D.....	340
POWER SERIES™ .....	343
QPAC .....	348
E-SAFE® II.....	353
SERIES CZR.....	356
Solid State Relays (SSR).....	359
<b>Operator Interfaces</b> .....	<b>363</b>
Silver Series EM.....	365
EZ-ZONE Remote User Interface (RUI) and Gateway .....	371
<b>Indicators</b> .....	<b>375</b>
EZ-ZONE PM .....	377
EZ-ZONE RUI and Gateway .....	378
SERIES TM.....	379
<b>Data Loggers</b> .....	<b>381</b>
F4T With INTUITION .....	383
EZ-ZONE RM System with Access Module .....	384
SpecView Human Machine Interface (HMI) Software .....	385
Silver Series EM.....	390
WATVIEW™ HMI Software .....	391
<b>Software</b> .....	<b>393</b>
COMPOSER® With INTUITION.....	395
EZ-ZONE Configurator.....	397
EZ-ZONE LabVIEW™ Driver.....	399
EZ-ZONE GSD Editor .....	400
EHG SL10 Software .....	401
SpecView HMI Software .....	402
EZwarePLUS .....	403
WATVIEW HMI Software .....	405

## Controllers (Continued)

<b>Accessories</b> .....	<b>407</b>
EZ-ZONE RUI and Gateway .....	409
Serial Converters .....	410
Combined Branch Protection and Semiconductor Fusing.....	412
Semiconductor Fuses.....	414
Current Transformers.....	415
Panel Mount Adapter Plates .....	416
Arc Suppression and EMI Filters.....	416
Power Supplies .....	417
<b>Control Panels</b> .....	<b>421</b>
Control Panels.....	423

## Index

<b>Part Number Index</b> .....	<b>427</b>
<b>Product Category Index</b> .....	<b>433</b>

## Terms and Conditions of Sale

<b>Terms and Conditions of Sale</b> .....	<b>435</b>
-------------------------------------------	------------

# Think Safety

All thermal systems pose inherent hazards if applied incorrectly. Improper application and failure to adhere to recognized national, state and local electrical codes as well as agency standards can result in injury to personnel or damage to plant and process.

Users are responsible for determining controller or sensor-to-application compatibility. Care should always be exercised in controller or sensor selection, installation and use.

Responsibility for sensor and controller installation and wiring lie with the customer. Each sensor, power and temperature controller is packaged with its own user manual. Be sure to review and understand the manual, which will help maximize safety, thermal system performance, efficiency and product life.

All Watlow® temperature and power controllers and sensors should be installed by qualified personnel who are knowledgeable about the thermal system's characteristics and in accordance with the National Electrical Code and any applicable state or local codes.

## Sensor Safety

If a sensor is used in a medical application, with life or death consequences, careful attention must be paid to its fit for the application with appropriate redundancies and/or alarms built into the product.

If the sensor is used in an industrial environment where hazards exist, protection methods (isolating sensors and wiring from explosive or flammable substances) should be considered to prevent failures or short circuits from becoming dangerous to personnel and property.

It is good engineering practice to always consider the consequences of a catastrophic failure and the affect it would have on personnel and property. Please institute the appropriate safeguards to limit any danger.

## Controller Safety

The following recommendations apply to all Watlow temperature and power controllers as well as control panels:

- Carefully read, understand and follow the instructions contained in the user manual.
- Always disconnect electrical power prior to installing, servicing or replacing temperature or power controllers.
- All temperature and power controllers should be used with approved conductors of the correct wire gauge.
- Do not use solid state power controllers in safety limit controller circuits. Solid state components tend to fail in a closed circuit mode and will not cut off power.



- Safety limit control should be provided by an isolated, redundant sensor and agency-approved controller of the appropriate type, design and installation.
- Electrical enclosures and/or control panels housing temperature and power controllers should match the application's environment and be able to withstand worst-case failures especially in hazardous locations.
- Do not apply temperature or power controllers where ambient conditions exceed specified operating environments and/or exceed power draw permitted by the device or applicable rating curve.
- Pay special attention to wiring practices. Power, sensor and communications wiring should be handled appropriately to avoid inductive and capacitive coupling. These conditions can create errant and/or erratic operation and pose a safety hazard. Use noise suppression devices where appropriate. Make ground connections for any device only to the appropriate electrical ground for that device (chassis, safety or computer ground).

# Think Safety

## Designing Safe Thermal Systems

Most heated thermal systems include:

- A heat source, either fuel fired or electrical resistance
- A temperature controller
- A temperature sensor

The sensor produces a signal value based on the temperature to which it is exposed. The temperature controller interprets the signal into a value that is either above, below or at a then predetermined set point. The controller will then create an output signal to command a device to turn the heat source on or off.

As with any heated thermal system, failure in the sensor, temperature controller or heat-source controlling device could create an over- or under-temperature condition. These conditions can ruin product in process or pose a danger to personnel and property.

Limit controllers are used to prevent injury and property loss that could occur if a process variable's value were to cross outside the safe operating range for the system. In systems where temperature is controlled, a limit controller should be used to respond to an over- or under-temperature condition before it becomes a hazard. A properly applied limit controller senses when the temperature or other process variable is outside the limit and shuts the system down.

The limit controller must be independent of the primary control system and able to interrupt the flow of energy that could cause a hazard. For example, in a system where temperature is controlled with an electric heater, the limit controller must be able to disconnect the heater from the power source when the temperature exceeds the limit. A proper design requires user intervention to correct the cause of the failure before the system is restored to normal operation.

Usually, the sensor used in a limit control system does not need to be as accurate as the primary sensor. Its only function is to create a temperature signal that allows a controller to determine if a pre programmed over-or under-temperature condition exists. Sensor longevity and aging must be considered if the sensor will have an unacceptable impact on the limit control system's ability to accurately determine an over- or under-temperature condition.

As with enclosures, there are agency standards for the design and construction of limit control systems, and their suitability for use exist.

## Designing Intrinsically Safe Circuits

When installing temperature sensors in hazardous areas, circuits should be made intrinsically safe with "barriers" to prevent sparks and excessive heat on the "safe" side from reaching the hazardous area and causing sparks.

All barrier device parameters affect sensor performance and the sensor circuit. Parameters include:

- Polarity rated for AC or DC signals
- Rated voltage or working voltage of the signal the device is designed to carry before it senses a fault
- Internal resistance, as the amount of resistance inherent to the barrier device, affects the strength of the current signal it is allowing to pass

# Watlow's Sensors, Wire and Cable Offering

Watlow manufactures sensor products to fit customer needs. A wide variety of temperature sensors including thermocouples, resistance temperature detectors (RTDs) and thermistors as well as wire, mineral insulated cable, connectors and hardware are supplied by and manufactured at Watlow's fully integrated facility.

Controlling all of the processes, beginning with selecting bare alloy, helps to ensure that all Watlow manufactured products meet the highest industry standards for performance, reliability and customer service. Watlow also has extensive test lab capabilities and uses a verification process at selected temperature points to ensure that products conform to ASTM error limits.

Watlow offers outstanding product and applications support as well as less than one week delivery for millions of standard product configurations.

For more complex needs, extended capability products that go beyond traditional functionality are available for large quantity orders. Please contact Watlow for specific application requirements and discuss which products may best fit the application.



# International Color Codes

ANSI Code	ANSI/ASTM T/C	ANSI/ASTM Exten.	BS 1843 (Britain)	DIN 43714 (Germany)	JIS C1610-1981 (Japan)	IEC 584-3 (Europe)	Common Uses
<b>B</b>							Suitable for use in an oxidizing or inert atmosphere. Do not insert in metal tubes. Beware of contamination at high temperatures. Not suitable for use below 122°F (50°C).
<b>E</b>							Suitable for use in an oxidizing or inert atmosphere. Limited use in vacuum or reducing atmosphere. Suitable for sub zero.
<b>J</b>							Reducing vacuum, inert atmosphere. Limited use in oxidizing above 1004°F (540°C). Not recommended for sub zero.
<b>K</b>							Suitable for use in an oxidizing or inert atmosphere. Limited use in vacuum or reducing atmosphere. Suitable for sub zero.
<b>N</b>							Alternative to Type K. More stable at high temperatures.
<b>R</b>							Suitable for use in an oxidizing or inert atmosphere. Do not insert in metal tubes. Beware of contamination at high temperatures.
<b>S</b>							Suitable for use in an oxidizing or inert atmosphere. Do not insert in metal tubes. Beware of contamination at high temperatures.
<b>T</b>							Mild oxidizing, reducing vacuum or inert atmosphere. Good where moisture is present. Low temperature and cryogenic applications.

# Table of Contents

## Sensors









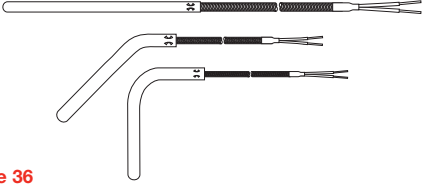

<b>Product Selection Guide</b> .....	<b>6</b>	<b>Resistance Temperature Sensors</b> .....	<b>87</b>
<b>Tolerances</b> .....	<b>14</b>	Resistance Temperature Detectors (RTDs) .....	88
<b>Lab Services</b> .....	<b>16</b>	Thermistors .....	99
<b>Thermocouples</b> .....	<b>23</b>	ENVIROSEAL™ HD.....	106
General Information .....	25	<b>Accessories</b> .....	<b>109</b>
General Applications Tube and Wire.....	32	Fittings.....	111
Mineral Insulated (MI).....	52	Thermowells .....	115
EXACTSENSE® .....	64	Protection Tubes .....	121
Base Metal .....	67	Connectors.....	125
High Temperature.....	71	Connection Heads and Blocks .....	132
MICROCOIL™ .....	78	Transmitters .....	134
Radio Frequency .....	80	<b>SERV-RITE® Wire</b> .....	<b>141</b>
TRUE SURFACE (TST) .....	82	General Information .....	142
Multipoints.....	84	Thermocouple and Extension Wire .....	143
		RTD Lead Wire.....	178
		<b>Mineral Insulated Cable</b> .....	<b>181</b>
		XACTPAK® Cable.....	183

# Product Selection Guide

## Sensors

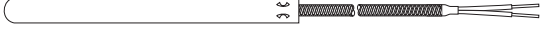
### Thermocouples

#### General Applications Tube and Wire

	Style	Maximum Temperature*	
		°F	°C
<b>Adjustable Spring</b>  See page 34	10 and 11	900	480
<b>Adjustable Armor</b>  See page 35	12	900	480
<b>Rigid Sheath</b>  See page 36	20, 21 and 22	900	480
<b>Rigid Sheath with Threaded Fitting</b>  See page 37	23 and 24	900	480
<b>Flange</b>  See page 38	25	900	480
<b>Rigid Sheath</b>  See page 39	30, 31 and 32	900	480
<b>Large Diameter Rigid Sheath</b>  See page 40	40, 41 and 42	900	480
<b>Flexible Extensions</b>  See page 41	60	900	480
<b>Insulated Wire</b>  See page 42	61 and 62	900	480
<b>PFA Encapsulated</b>  See page 43	65	900	480

\*Note: Maximum temperature of 900°F (482°C) is for fiberglass insulated wire only. PFA insulated wire is rated for 500°F (260°C).









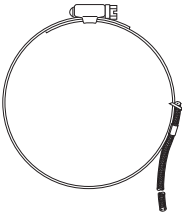

# Product Selection Guide

## Sensors

### Thermocouples

#### General Applications Tube and Wire

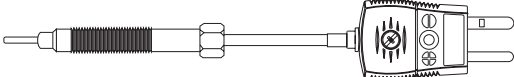
	Style	Maximum Temperature*	
		°F	°C
<b>Ring Terminal</b>  See page 44	70	900	480
<b>Nozzle</b>  See page 45	71	900	480
<b>Pipe Clamp</b>  See page 46	72	900	480
<b>Grommet</b>  See page 47	73	900	480
<b>Brass Shim</b>  See page 48	74	500	260
<b>Stainless Steel Shim</b>  See page 49	75	900	480
<b>Polyimide Bracket</b>  See page 50	OK	400	200
<b>Low Profile Polyimide Peel and Stick</b>  See page 50	OK	400	200
<b>Melt Bolt</b>  See page 51	M1 and M3	500	260









\*Note: Maximum temperature of 900°F (482°C) is for fiberglass insulated wire only. PFA insulated wire is rated for 500°F (260°C).

# Product Selection Guide

## Sensors

### Thermocouples

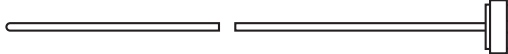
#### Mineral Insulated

	Style	Maximum Temperature*	
		°F	°C
<b>Cut and Stripped</b>  See page 56	AB	2200	1200
<b>Mini Plug or Jack Termination</b>  See page 57	AC	2200	1200
<b>Standard Plug or Jack Termination</b>  See page 58	AC	2200	1200
<b>Metal Transitions with Spring Strain Relief</b>  See page 59	AF	2200	1200
<b>Miniature Transitions</b>  See page 60	AQ	2200	1200
<b>Connection Head</b>  See page 61	AR	2200	1200
<b>Wafer Head</b>  See page 62	AS	2200	1200
<b>For Use With Thermowells</b>  See page 63	AT	2200	1200

\*Note: Maximum temperature of 2200°F (1204°C) is for Inconel® only. SST sheath is rated for 1650°F (899°C).

# Product Selection Guide

## Sensors

### Thermocouples

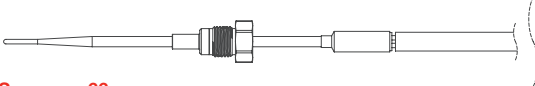

#### EXACTSENSE®

	Style	Maximum Temperature	
		°F	°C
<b>Integrated Signal Conditioning</b>  See page 66	EXACTSENSE®	1832	1100

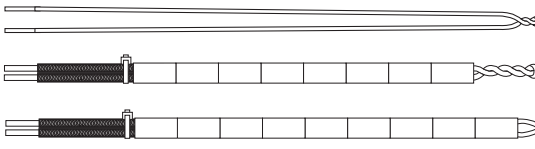
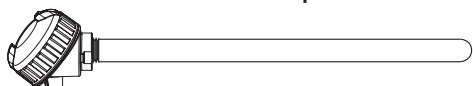
#### Base Metal

	Style	Maximum Temperature	
		°F	°C
<b>Bare Elements and Elements with Insulators</b>  See page 68	14_ _ and 15_ _	2200	1200
<b>Base Metal Standard Thermocouple with Protection</b>  See page 69	1409 1414 1507 1517	2200	1200

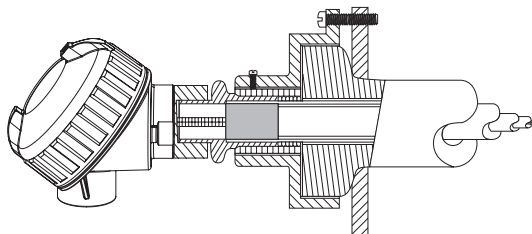
#### High Temperature

	Style	Maximum Temperature	
		°F	°C
<b>Noble Metal</b>  See page 72	211_	3100	1700
<b>Noble Metal Thermocouple Assemblies</b>  See page 73	214_	3100	1700
<b>Exotic Metal Sheath Plug or Jack Termination</b>  See page 76	HC	3450	1900
<b>Exotic Metal Sheath Metal Transitions</b>  See page 77	HF	3450	1900

# Product Selection Guide

## Sensors

### Thermocouples

#### MICROCOIL™

	Style	Maximum Temperature	
		°F	°C
<b>Miniature Surface Probe</b>  See page 79	MC	1292	700

#### Radio Frequency

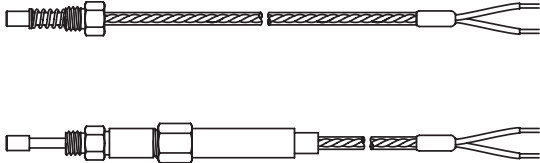
	Style	Maximum Temperature	
		°F	°C
<b>Thermocouple Probe</b>  See page 81	TR	932	500

#### TRUE SURFACE

	Style	Maximum Temperature	
		°F	°C
<b>Insulated Surface Probe</b>  See page 83	TST	400	200

#### Multipoint





	Style	Maximum Temperature	
		°F	°C
<b>Multipoint</b>  See page 85	AW	2200	1200

# Product Selection Guide

## Sensors

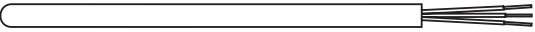
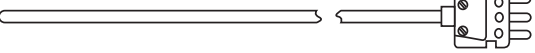
### Resistance Temperature Sensors

#### Resistance Temperature Detectors (RTDs)



	Style	Maximum Temperature	
<b>Standard Industrial Insulated Leads</b>  See page 92	RB	500	260
<b>Plug or Jack Termination</b>  See page 93	RC	500	260
<b>Metal Transitions</b>  See page 94	RF	1200	650
<b>Connection Head/Optional Transmitter</b>  See page 95	RR	1200	650
<b>For Use With Thermowells</b>  See page 96	RT	1200	650
<b>Adjustable Spring</b>  See page 97	10 and 11	500	260

# Product Selection Guide

## Sensors

### Resistance Temperature Sensors

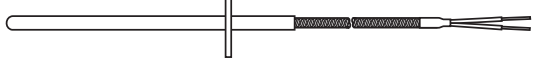
#### RTDs

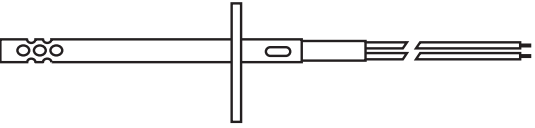
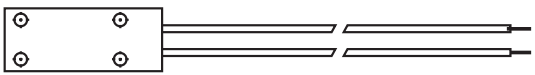



	Style	Maximum Temperature	
		°F	°C
<b>Adjustable Armor Style</b>  See page 97	12	500	260
<b>Cartridge with Flange</b>  See page 97	25	500	260
<b>Open Air</b>  See page 97	50	500	260
<b>Open Air with Flange</b>  See page 97	55	500	260
<b>Surface Mount</b>  See page 97	80	500	260

# Product Selection Guide

## Sensors

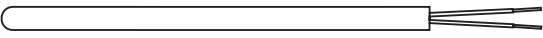
### Resistance Temperature Sensors

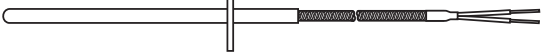
#### Thermistors

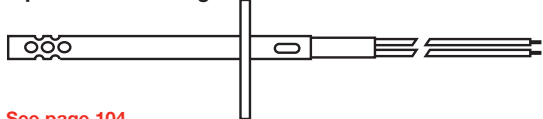
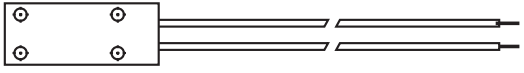
	Style	Maximum Temperature	
		°F	°C
<b>Standard Industrial Thermistor with Insulated Leads</b>  See page 103	TB	500	260
<b>Adjustable Spring Style</b>  See page 104	10 and 11	500	260
<b>Adjustable Armor Style</b>  See page 104	12	500	260
<b>Cartridge with Flange</b>  See page 104	25	500	260
<b>Open Air</b>  See page 104	50	500	260
<b>Open Air with Flange</b>  See page 104	55	500	260
<b>Surface Mount</b>  See page 104	80	500	260

#### ENVIROSEAL™ HD

	Style	Maximum Temperature	
		°F	°C
 See page 107	HD	392	200

# Tolerances

## Thermocouples

### ANSI Tolerances

As of 1969, nomenclature of the American National Standards Institute, Inc. (ANSI) supersedes previously used International Society of Automation (ISA) designations. The standard and special tolerances in the table below come from ANSI Circular ASTM E230.

Standard and special tolerances stated below apply only to temperature ranges listed for each thermocouple type.

### Letter Designations

ANSI Letter	T/C Leg	Popular Generic and Trade Names
B	BP BN	Platinum 30% Rhodium Platinum 6% Rhodium
E	EP EN	Chromel®, Tophel®, HAI-KP® Constantan, Cupron®, Advance®
J	JP JN	Iron Constantan, Cupron®, Advance®
K	KP KN	Chromel®, Tophel®, HAI-KP® Alumel®, Nail®, HAI-KN®
N	NP NN	Nicrosil Nisil
R	RP RN	Platinum 13% Rhodium Pure Platinum
S	SP SN	Platinum 10% Rhodium Pure Platinum
T	TP TN	Copper Constantan, Cupron, Advance

## Sheath Tolerances

Length and diameter are important considerations for proper installation of temperature sensors. The tables below provide tolerances on these key dimensions of Watlow catalog sensor products.

General Application and RTD Sheath Tolerances		
Sheath Diameter (in.)	Diameter Tolerance (in.)	Length Tolerance (in.)
1/8	± 0.003	± 0.125
3/16	± 0.003	± 0.125
1/4	± 0.003	± 0.125
5/8	± 0.003	± 0.250

Mineral Insulated (MI) Thermocouple Sheath Tolerances			
Diameter (in.)	Diameter Tolerance (in.)	Length Tolerance (in.)	
		up to 24 in.	over 24 in.
0.020	+ 0.001 - 0.0005	± 0.25	± 1%
0.032	+ 0.001 - 0.0005	± 0.25	± 1%
0.040	+ 0.001 - 0.0005	± 0.25	± 1%
0.063	+ 0.001 - 0.001	± 0.125	± 1/2%
0.125	+ 0.002 - 0.001	± 0.125	± 1/2%
0.188	+ 0.002 - 0.001	± 0.125	± 1/2%
0.250	+ 0.003 - 0.001	± 0.125	± 1/2%

### Flexible Lead Tolerances

General Application, MI Thermocouple and RTD Lead Length	
Lead Length (in.)	Tolerance (in.)
Under 6	+ 1 - 0
6 to 24	+ 2 - 0
Over 24 to 120	+ 6 - 0
Over 120	+ 5% - 0

Note: Strip length tolerances ±1/8 inch.



# Tolerances

## Sheath Configuration

Standard shipping methods and element strength require that long length mineral insulated sensors be shipped in coil format. This chart provides the standard sheath configuration by diameter.

### MI Thermocouple Standard Sheath Configuration

Sheath Diameter in.	Standard Length in.	Configuration
0.020	Up to 20	Straight
0.032	From 20 to 170 170 to 300 greater than 300	3 in. coil 6 in. coil 9-10 in. coil
0.040	Up to 20 From 20 to 120 120 to 200 Greater than 200	Straight 3 in. coil 6 in. coil 9-10 in. coil
0.063	Up to 50 50 to 540 (45 feet) Greater than 540 (45 feet)	Straight 9-10 in. coil 24 in. coil
0.125 0.188 0.250	Up to 96 Greater than 96	Straight 24 in. coil

## Metal Substitution

On standard catalog items, Watlow reserves the right to substitute superior materials of construction without notification. These can include, but are not limited to, superior metals and special limits of error wire.

## Initial Accuracy of Temperature Sensors

Industry specifications establish the accuracy limits of industrial temperature sensors. These limits define initial sensor performance at the time of manufacture. Time, temperature and environmental operating conditions may

cause sensors to change during use. Also, consider that overall system accuracy will depend on the instrument and other installation parameters.

### Thermocouples – Tolerances on Initial Values of Electromotive Force vs. Temperature

Reference Junction 32°F (0°C)

Calibration Type	Temperature Range °F                      °C		Tolerances (whichever is greater)			
			°F	Standard (°C)	°F	Special (°C)
<b>Thermocouples</b> <sup>①</sup> <sup>③</sup>						
B	1600 to 3100	(870 to 1700)		±0.5%		±0.25%
E	32 to 1600	(0 to 870)	②	(±1.7 or ±0.5%)	②	(±1.0 or ±0.4%)
J	32 to 1400	(0 to 760)	②	(±2.2 or ±0.75%)	②	(±1.1 or ±0.4%)
K or N	32 to 2300	(0 to 1260)	②	(±2.2 or ±0.75%)	②	(±1.1 or ±0.4%)
R or S	32 to 2700	(0 to 1480)	②	(±1.5 or ±0.25%)	②	(±0.6 or ±0.1%)
T	32 to 700	(0 to 370)	②	(±1.0 or ±0.75%)	②	(±0.5 or ±0.4%)
E <sup>④</sup>	-328 to 32	(-200 to 0)	②	(±1.7 or ±1%)	②	⑤
K <sup>④</sup>	-328 to 32	(-200 to 0)	②	(±2.2 or ±2%)	②	⑤
T <sup>④</sup>	-328 to 32	(-200 to 0)	②	(±1.0 or ±1.5%)	②	⑤
<b>Extension Wires</b> <sup>⑥</sup> <sup>⑦</sup>						
EX	32 to 400	(0 to 200)	±3.0	(±1.7)	±1.8	(±1.0)
JX	32 to 400	(0 to 200)	±4.0	(±2.2)	±2.0	(±1.1)
KX or NX	32 to 400	(0 to 200)	±4.0	(±2.2)	±2.0	(±1.1)
TX	32 to 200	(0 to 100)	±1.8	(±1.0)	±0.9	(±0.5)
<b>Compensating Extension Wires</b> <sup>⑧</sup> <sup>⑨</sup>						
RX, SX	32 to 400	(0 to 200)	±9.0	(±5.0)	*	*

① Tolerances in this table apply to new, essentially homogeneous thermocouple wire, normally in the size range 0.25 to 3 mm in diameter (No. 30 to No. 8 AWG) and used at temperatures not to exceed the recommended limits shown above. If used at higher temperatures, these tolerances may not apply.

② At a given temperature that is expressed in °C, the tolerance expressed in °F is 1.8 times larger than the tolerance expressed in °C. Note: Wherever applicable, percentage-based tolerances must be computed from temperatures that are expressed in °C.

③ **Caution:** Users should be aware that certain characteristics of thermocouple materials, including the EMF vs. temperature relationship, may change with time in use. Consequently, test results and performance obtained at the time of manufacture may not necessarily apply throughout an extended period of use. Tolerances provided above apply only to new wire as delivered to the user and do not allow for changes in characteristics with use. The magnitude of changes will depend on factors such as wire size, temperature, time of exposure and environment. Further noted that due to possible changes in homogeneity, attempting to recalibrate used thermocouples is likely to yield irrelevant results and is not recommended. However, it may be appropriate to compare used thermocouples in-situ with new or known good thermocouples to ascertain their suitability for further service under conditions of comparison.

④ Thermocouples and thermocouple materials are normally supplied to meet tolerances specified in the table for temperatures above 0°C. The same materials, however, may not fall within the tolerances given for temperatures below 0°C in the second section of the table. Materials required to meet tolerances stated for temperatures below 0°C must be stated in the purchase order. Selection of materials will usually be required.

⑤ Special tolerances for temperatures below 0°C are difficult to justify due to limited available information. However, the following values for Types E and T thermocouples are suggested as a guide for discussion between purchaser and supplier: Type E: -200 to 0°C ±1.0°C or ±0.5 percent (whichever is greater); Type T: -200 to 0°C ±0.5 or ±0.8 percent (whichever is greater).

Initial values of tolerance for Type J thermocouples at temperatures below 0°C, and special tolerances for Type K thermocouples below 0°C, are not given due to characteristics of the materials.

⑥ Tolerances shown in the table represent the maximum error contribution allowable from new and essentially homogeneous thermocouple extension wire when exposed to the full temperature range shown above. Extension grade materials are not intended for use outside of the temperature range shown.

⑦ Thermocouple extension wire contributes to the total thermoelectric signal that depends on the temperature difference between the extreme ends of the extension wire length. The actual magnitude of any error introduced into a measuring circuit by homogeneous and correctly connected extension wires is equal to the algebraic difference of the deviations at its two end temperatures, as determined for that extension wire pair.

⑧ Tolerances in the table apply to new and essentially homogeneous thermocouple compensating extension wire when used at temperatures within the range shown above.

⑨ Thermocouple compensating extension wire contributes to the total thermoelectric signal that depends on the temperature difference between the extreme ends of the compensating extension wire length.

\* Special tolerance grade compensating extension wires are not available.

## Initial Accuracy of Temperature Sensors (Continued)

Generally, if accuracy is the most important concern and the application temperature is between 284°F and 1202°F (140°C and 650°C), RTDs are the best choice.

### Resistance Temperature Detectors—RTDs

Table of Tolerance Values

Temperature °C	Resistance Value Ω	Tolerance DIN-IEC-751			
		Class A °C (Ω)		Class B °C (Ω)	
-200	18.52	±0.55	(±0.24)	±1.3	(±0.56)
-100	60.26	±0.35	(±0.14)	±0.8	(±0.32)
0	100.00	±0.15	(±0.06)	±0.3	(±0.12)
100	138.51	±0.35	(±0.13)	±0.8	(±0.30)
200	175.86	±0.55	(±0.20)	±1.3	(±0.48)
300	212.05	±0.75	(±0.27)	±1.8	(±0.64)
400	247.09	±0.95	(±0.33)	±2.3	(±0.79)
500	280.98	±1.15	(±0.38)	±2.8	(±0.93)
600	313.71	±1.35	(±0.43)	±3.3	(±1.06)
650	329.64	±1.45	(±0.46)	±3.6	(±1.13)

Where **t** is the actual temperature, in °C, of the platinum elements.

#### RTD Tolerance Class Definitions

DIN class A:  $\pm[0.15 + 0.002 |t|]^\circ\text{C}$

DIN class B:  $\pm[0.30 + 0.005 |t|]^\circ\text{C}$

Three-wire is most common, but four-wire provides higher system accuracy.

### Thermistors

Thermistors are a cost effective choice when working with a narrow range of temperatures.

- Resistance at 77°F (25°C) and ranges:

Epoxy Bead Tolerance ±1%Ω (+0.3°C)		
#11	1000Ω	-76 to 302°F (-60 to 150°F)
#12	3000Ω	-76 to 302°F (-60 to 150°F)

Glass Bead Tolerance ±15%Ω (+3°C)		
#16	100,000Ω	-76 to 500°F (-60 to 260°F)

**Note:** Other thermistors available on request.

## Thermocouple Accuracy

Watlow uses a verification process at selected temperature points to assure wire and XACTPAK products conform to ASTM error limits. Samples are taken to the Watlow calibration laboratory and verified for accuracy with NIST traceable standards. Conformance to error limits is required at all test temperatures. The following charts provide the standard test temperatures by thermocouple type.

### XACTPAK and Mineral Insulated (MI) Thermocouples

Calibration	Standard Calibration Points °F*
E	200, 600, 1000, 1600
J	200, 600, 1000, 1400
K	600, 1000, 1600, 2000
N	600, 1000, 1600, 2000
T	200, 400

### SERV-RITE Insulated Wire

Calibration	Standard Calibration Points °F*
E	300, 500, 1000, 1600
J	200, 500, 1000, 1400
K	300, 500, 1000, 1600, 2000
N	300, 500, 1000, 1600, 2000
T	200, 500
EX	200, 400
JX	200, 400
KX	200, 300, 400
NX	200, 300, 400
RX	400
SX	400
TX	200

\* Calibration is not made when temperature exceeds the sheath rating.

## Quality Certification Lab (Continued)

### Thermocouple Calibration

Watlow offers testing for application temperatures other than the standard points in a range from -320 to 3050°F (-195 to 1677°C), depending on material. Use outside of the temperature limits of ASTM E230 is not recommended.



A lab service technician uses a metallurgical microscope to examine the microstructure of the metallic components in Watlow's mineral insulated metal sheathed cable, XACTPAK.

### Thermocouple Calibration Table

Sensor Type	Temperature	Specifications
E, J, K, N, T Thermocouple	-320°F and -110 to 32°F (-195°C and -80 to 0°C)	ASTM E220/ASTM E230
T Thermocouple	32 to 700°F (0 to 371°C)	ASTM E220/ASTM E230
J Thermocouple	32 to 1400°F (0 to 760°C)	ASTM E220/ASTM E230
E Thermocouple	32 to 1600°F (0 to 871°C)	ASTM E220/ASTM E230
K or N Thermocouple	32 to 2300°F (0 to 1260°C)	ASTM E220/ASTM E230
R or S Thermocouple	32 to 2500°F (0 to 1371°C)	ASTM E220/ASTM E230
B Thermocouple	1600 to 2500°F (870 to 1371°C)	ASTM E220/ASTM E230
PT 385 100Ω RTD	-320°F and -110 to 1200°F (-195°C and -80 to 650°C)	ASTM E644

#### Notes:

- Thermocouple calibrations to ASTM E207 possible (contact factory).
- For Type R and S thermocouple, calibration below 1000°F is not accredited to ISO-17025.
- For Type B thermocouple, calibration below 1500°F is not accredited to ISO-17025.

### Recommended Sensor Length for Calibration

Temperature	Minimum Length	Maximum Length
-320°F (-195°C)	20 in. (500 mm)	60 in. (1525 mm)
-110 to 500°F (-80 to 260°C)	6 in. (150 mm)	60 in. (1525 mm)
500 to 2000°F (260 to 1093°C)	18 in. (450 mm)	10 ft (3 m)
2000 to 2500°F (1093 to 1371°C)	20 in. (500 mm)	10 ft (3 m)

Notes: Longer sensors may be calibrated if they are in coil form.

### Recommended RTD Length for Calibration

Temperature	Minimum Length	Maximum Length
-320°F (-195°C)	20 in. (500 mm)	60 in. (1525 mm)
-110 to 500°F (-80 to 260°C)	6 in. (150 mm)	60 in. (1525 mm)
500 to 1200°F (260 to 650°C)	18 in. (450 mm)	10 ft (3 m)

## Quality Certification Lab (Continued)

### Calibration and Certification

SERV-RITE® thermocouple wire, XACTPAK® metal sheathed cable and individual temperature sensors can be calibrated and certified in Watlow's ISO 17025 accredited laboratory for an extra charge. Each thermocouple, coil, reel or spool of wire is tagged to show the individual departure from curve. Once calibrated, exact departure from the standard curve at any specified temperature is known and considered. Thermocouples and wire samples sent to the factory for calibrating must be at least 36 inches in length.

Calibrating temperature points range from 32 to 2300°F (0 to 1260°C), depending on calibration, gauge size and insulation. Sub-zero and cryogenic calibration is available at fixed points, such as boiling helium, nitrogen and sublimated carbon dioxide, including temperatures down to -110°F (-80°C).

A certificate of calibration and a calibration results tag are furnished for all items calibrated.

### Common Certifications

The following standard certifications are available from Watlow. Requirements for the following standard certifications available from Watlow must be stated on an order. Certificates #1, 2, 3 and 4 are only available as a "Certificate Package" comprised of all four certificates.

#### Certificate #1 - Certificate of Compliance/Conformity

This certification states that the product supplied meets the purchase order requirements.

#### Certificate #2 - Certificate of Compliance to ASTM E230 Tolerance

This certification states that the product being supplied meets the purchase order requirements, including the correct calibration type and tolerance. This certification is also used when conformance to ASTM E230 must be documented.

#### Certificate #3 - Certificate of Conformance to ISO 10012

This certificate certifies that Watlow's calibration system is in accordance with ISO 10012.

#### Certificate #4 - Certificate of Traceability to National Institute of Standards and Technology (NIST)

This certification certifies that the materials received are traceable to NIST via calibration data of the thermoelements used to manufacture the product.

#### Certificate #5 - Certificate of Calibration for Bulk XACTPAK

This calibration certificate provides overall lot calibration data for the bulk XACTPAK. The data will indicate how the final sensor will perform without the additional cost to calibrate each individual sensor.

#### Certificate #6 - Certificate of Calibration for Bulk SERV-RITE Insulated Wire

This calibration certification provides preproduction calibration values of the insulated wire product at standard calibration check points.

#### Certificate #7 - Chemical Composition of Conductors Used in Insulated Wire Products

Watlow tubing and insulator vendors supply certification on the chemical composition and physical characteristics of their products (material certification) with each lot received. When requested, certifications are duplicated (proprietary information is blocked out) and sent to customers.

#### Certificate #7A - Chemical Composition of Conductors Used in Insulated Wire Products

This certification offers nominal chemical composition of the alloy used in insulated wire products.

#### Certificate #8 - Certificate of Calibration at Specified Temperatures

This calibration certification provides post-production calibration data. Calibration is performed in the Watlow calibration laboratory with NIST traceable calibration standards. In addition to calibration data, the test standard, equipment, NIST traceability and reference to applicable calibration procedures are stated.

## Quality Certification Lab

The Watlow calibration lab is ISO 17025 accredited. Watlow certification verifies that the finished sensor complies with initial calibration tolerances as established by ASTM Standard E 230. This standard is based on the thermodynamic temperature scale of ITS 90. Initial sensor tolerances are susceptible to change during use due to environmental factors, including contamination, temperature, furnace gradient and physical abuse. Watlow's advanced capabilities enable sensor calibration across a broad range of temperatures, from cryogenic -320 to 3050°F (-195 to 1677°C).

ISO 10012 is the standard for all sensor and instrument calibration and results are traceable to the National Institute of Standards and Technology (NIST). Following are standard methods and specifications for sensor calibration:

- ASTM E207
- ASTM E220
- ASTM E230
- ASTM E644
- AMS 2750

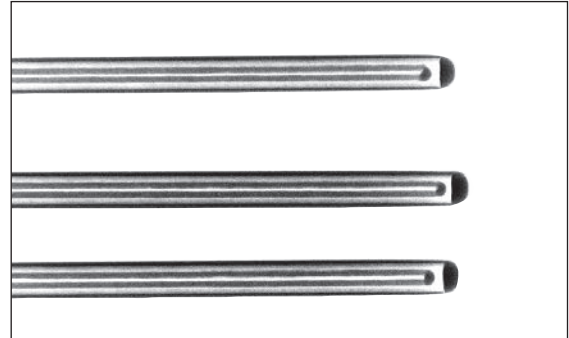

**Sensor X-rays verify the nonexistence of cracks at weld points that could let in humidity or gas and potentially shorten the life of the thermocouple.**

## Certification Testing Offered

Service	Description	Specifications
End-to-end calibration	Compares each end of a length of thermocouple wire, utilizing a common junction measurement test. This is a requirement to verify homogeneity requirements.	ASTM E207, E220, E230
Dielectric testing	Performance levels of wire insulations in the presence of high, local fields caused by electrical discharges. Routinely used in Watlow quality control testing.	ASTM D149
Helium leak test	Verifies the sheath integrity in metal-sheathed cable and sensors to 1000 psi (70 kg/cm <sup>2</sup> ) in specially designed pressure chambers.	ASTM E235
Radiographic inspection	Determines dimensions and detects and evaluates cracks, voids, inclusions and discontinuities. Technicians are qualified under SNT-TC-1A.	ASTM E94, E142
Metallographic examination	Reveals the constituents and structures of metals. Photomicrographs are also available to determine and document average grain size and structure of prepared specimens.	ASTM E3, E112, E235
Compaction density test	Determines compaction of insulating materials in metal-sheathed cable.	ASTM D2771
Drift test	Determines long-term stability and drift characteristics.	ASTM E601, E644
Thermal cycle test	Subjects individual sensors to repeated cycling through a temperature range.	ASTM E235
Insulation resistance	Measures electrical insulation resistance properties between thermoelements and the sheath at ambient as well as elevated temperatures to determine presence of moisture or impurities which could affect sensor performance.	ASTM E780, E235, E644
Micro-hardness	Determines hardness of sheath or conductors used to measure a material's resistance to penetration (hardness) as a predictor of strength, machinability, brittleness, ductility and wear resistance.	Vicker's

## General Information

Watlow® offers a wide variety of product test capabilities to verify that the products developed and produced by Watlow meet the most rigorous industry standards.

Watlow continuously invests in developing capabilities to ensure that the proper testing is completed for optimum sensor performance in the customer's application. Below is a list of current Watlow test capabilities.

### Time response

- Measures sensor output relative to a step change in temperature from ambient up to 160°F (70°C) per ASTM

### Vibration

- Sine and random electrodynamic excitation

### High temperatures

- Up to 3050°F (1677°C)

### Cryogenic temperatures

- Up to -320°F (-195°C) for liquid nitrogen;  
-110°F (-80°C) continuously variable up to 32°F (0°C)

### Tensile and compression

- Testing to 1,000 lb (500 kg)

### Humidity

- To 200°F/95 percent RH (95°C/95 percent RH)

### Life testing

- In molten aluminum and corrosive liquids

### Cycle and drift

- Testing up to 2190°F (1200°C)

### Wire insulation abrasion testing

- Repeated scrape and wire to wire

### Micro-hardness

- Vicker's scale or conversion to other common scales

### Dielectric breakdown testing

- Capabilities to 5000VDC





# Thermocouples

Product	Description	Temperature		Page
		°F	°C	
<b>General Applications Tube and Wire</b>	Feature SERV-RITE® wire in a variety of insulation types with a metal sheath over the thermocouple. Wide variety of mounting options for use in general industrial and commercial applications.	Up to 900	Up to 480	<b>32</b>
<b>Mineral Insulated</b>	Fast responding, durable and capable of handling high temperatures with the use of XACTPAK® metal sheathed cable with compacted MgO insulation.	Up to 2200	Up to 1200	<b>52</b>
<b>EXACTSENSE®</b>	Exhaust gas temperature sensor that combines rugged thermocouple technology with signal conditioning into one package. The primary benefits are high accuracy, durability, quick response, long immersion depth and high temperature.	-104 to 2192	-40 to 1200	<b>64</b>
<b>Base Metal</b>	Large gauge, bare alloy available with ceramic insulated elements and protection tubes. Available in ASTM E230 Types K and J.	Up to 2300	Up to 1260	<b>67</b>
<b>High Temperature</b>	Available in ASTM E230 Types S or R with a variety of high temperature sheath materials capable of withstanding high temperatures.	Up to 3100	Up to 1700	<b>71</b>
<b>MICROCOIL™</b>	Miniature thermocouple provides surface temperature measurement.	Up to 1292	Up to 700	<b>78</b>
<b>Radio Frequency</b>	Thermocouple designed for use in plasma generation applications.	Up to 932	Up to 500	<b>80</b>
<b>TRUE SURFACE</b>	Flat surface temperature sensor that isolates the thermocouple from ambient airflow.	Up to 400	Up to 200	<b>82</b>
<b>Multipoints</b>	Accurately measures temperatures at various locations. Constructed with a variety of protection tubes with XACTPAK mineral insulated metal sheathed cable.	Up to 2200	Up to 1200	<b>84</b>

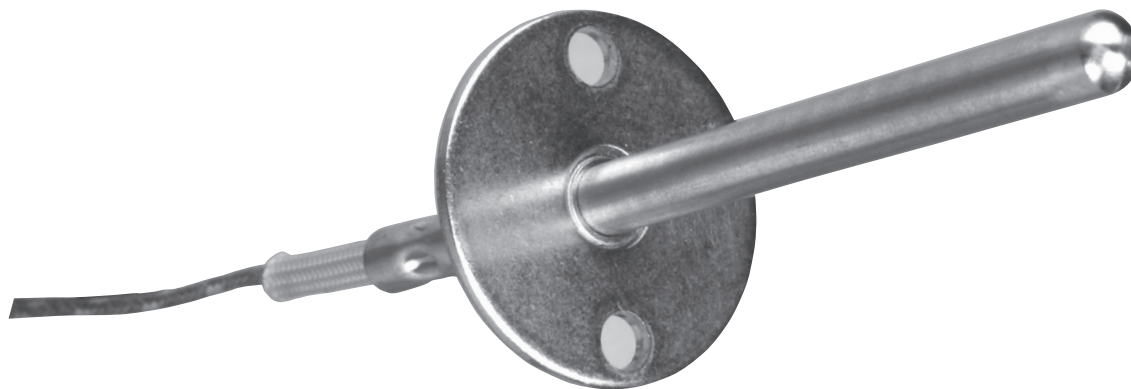



# Thermocouples

## General Information

### Calibration Types

Thermocouples are classified by calibration type because they have varying electromotive force (EMF) versus temperature curves. Some generate considerably more voltage at lower temperatures, while others do not begin to develop a significant voltage until subjected to high temperatures. Also, calibration types are designed to deliver as close to a straight line voltage curve inside their temperature application range as possible. This makes it easier for an instrument or temperature controller to correctly correlate the received voltage to a particular temperature.

Additionally, thermocouple calibration types have different levels of compatibility with different atmospheres. Chemical reaction between certain thermocouple alloys and the application atmosphere could cause metallurgy degradation, making another calibration type more suitable for sensor life and accuracy requirements.

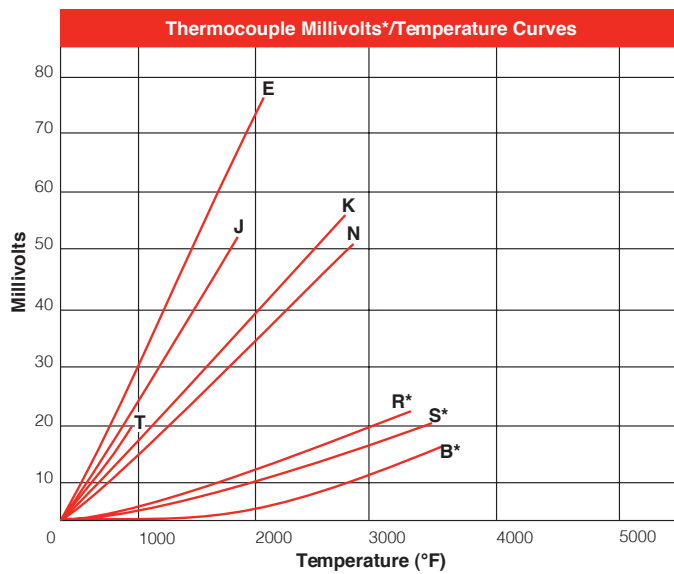

\*Millivolt values shown for R and S calibrations pertain to thermocouple calibrations only. RX and SX constructions described in this catalog section are intended for use as **extension wire only** and will not exhibit the millivolt outputs shown.

### Thermocouple Types

Calibration types have been established by the American Society for Testing and Materials (ASTM) according to their temperature versus EMF characteristics in accordance with ITS-90, in standard or special tolerances.

Additionally, there are non-ASTM calibration types. These thermocouples are made from tungsten and tungsten-rhenium alloys. Generally used for measuring higher temperatures, they are a more economical alternative to the platinum and platinum alloy based noble metal thermocouples, but limited to use in inert and non-oxidizing atmospheres.

Thermocouple Type	Useful/General Application Range
B	1600-3100°F (870-1700°C)
E*	200-1650°F (95-900°C)
J	200-1400°F (95-760°C)
K*	200-2300°F (95-1260°C)
N	200-2300°F (95-1260°C)
R	32-2700°F (0-1480°C)
S	32-2700°F (0-1480°C)
T*	32-660°F (0-350°C)

\*Also suitable for cryogenic applications from -328 to 32°F (-200 to 0°C)

# Thermocouples

## General Information

### Calibration Types

#### Type B

Maximum recommended operating temperature for Type B is 3100°F (1700°C). Suitable for use in an oxidizing or inert atmosphere. Do not insert in metal tubes. Beware of contamination at high temperatures. Not suitable for use below 122°F (50°C).

#### Type E

The Type E thermocouple is suitable for use at temperatures up to 1650°F (900°C) in a vacuum, inert, mildly oxidizing or reducing atmosphere. At cryogenic temperatures, the thermocouple is not subject to corrosion. This thermocouple has the highest EMF output per degree of all the commonly used thermocouples.

#### Type J

Type J is the second most common calibration type and is a good choice for general purpose applications where moisture is not present.

The Type J thermocouple may be used, exposed or unexposed, where there is a deficiency of free oxygen. For cleanliness and longer life, a protection tube is recommended. Since iron (JP) wire will oxidize rapidly at temperatures over 1000°F (540°C), it is recommended that larger gauge wires be used to compensate. Maximum recommended operating temperature is 1400°F (760°C).

#### Type K

Type K thermocouples usually work in most applications as they are nickel based and exhibit good corrosion resistance. It is the most common sensor calibration type providing the widest operating temperature range.

Due to its reliability and accuracy the Type K thermocouple is used extensively at temperatures up to 2300°F (1260°C). This type of thermocouple should be protected with a suitable metal or ceramic protection tube, especially in reducing atmospheres. In oxidizing atmospheres, such as electric furnaces, tube protection is not always necessary when other conditions are suitable; however, it is recommended for cleanliness and general mechanical protection. Type K will generally outlast Type J because the JP wire rapidly oxidizes, especially at higher temperatures.

#### Type N

This nickel-based thermocouple alloy is used primarily at high temperatures up to 2300°F (1260°C). While not a direct replacement for Type K, Type N provides better resistance to oxidation at high temperatures and longer life in applications where sulfur is present. It also outperforms Type K in K's aging range.

#### Types S and R

Maximum recommended operating temperature for Type S or R is 2700°F (1480°C). These thermocouples are easily contaminated. Reducing atmospheres are particularly damaging to the calibration. Noble metal thermocouples should always be protected with a gas-tight ceramic tube, a secondary tube of porcelain, and a silicon carbide or metal outer tube as conditions require.

#### Type T

This thermocouple can be used in either oxidizing or reducing atmospheres, though for longer life, a protecting tube is recommended. Because of its stability at lower temperatures, this is a superior thermocouple for a wide variety of applications in low and cryogenic temperatures. Its recommended operating range is -330° to 660°F (-200° to 350°C), but it can be used up to -452°F (-269°C) (boiling helium).

# Thermocouples

## General Information

### Maximum Temperatures

The diameter of the sensor wires determines the upper most operating temperature. The larger the diameter, the higher the temperature rating.

Choose alloy 600 over 304 stainless steel (SS) or 316 SS when higher temperatures are expected.

The environment is also a critical factor when determining the best material to use. Consult the manual on **The Use of Thermocouples in Temperature Measurement**, published by ASTM for further details.

### Recommended Upper Temperature Limit for Protected Thermocouple Wire

Thermocouple Type	No. 8 Gauge °F (°C)	No. 14 Gauge °F (°C)	No. 20 Gauge °F (°C)	No. 24 Gauge °F (°C)	No. 28 Gauge °F (°C)
E	1600 (870)	1200 (650)	1000 (540)	800 (430)	800 (430)
J	1400 (760)	1100 (590)	900 (480)	700 (370)	700 (370)
K and N	2300 (1260)	2000 (1190)	1800 (980)	1600 (870)	1600 (870)
R and S				2700 (1480)	
T		700 (370)	500 (260)	400 (200)	400 (200)

This table gives the recommended upper temperature limits for the various thermocouples and wire sizes. These limits apply to protected thermocouples in conventional closed-end protecting tubes. They do not apply to sheathed thermocouples with compacted mineral oxide insulation.

The temperature limits shown here are intended only as a guide and should not be taken as absolute values nor as guarantees of satisfactory life or performance. These types and sizes are sometimes used at temperatures above the given limits, but usually at the expense of stability, life or both. In other instances, it may be necessary to reduce the above limits to achieve adequate service.

### Mineral Insulated Sensors by Diameter and Sheath

Sheath Diameter in.	Calibration	Sheath Material	Maximum Recommended Operating Temperature	
			°F	(°C)
0.032	K	304 SS/Alloy 600	1600	(871)
0.032	J	304 SS	1500	(816)
0.040	K	304 SS/316 SS/Alloy 600	1600	(871)
0.040	J	304 SS	1500	(816)
0.040	T	304 SS	662	(350)
0.040	E	304 SS	1600	(871)
0.063	K or N	Alloy 600	2000	(1093)
0.063	S	Alloy 600	2000	(1093)
0.063	J	304 SS/316 SS	1500	(816)
0.063	E	304 SS	1600	(871)
0.063	K	304 SS/316 SS	1600	(871)
0.063	K	Hastelloy® X	2200	(1204)
0.125	K or N	Alloy 600	2150	(1177)
0.125	T	304 SS/316 SS/Alloy 600	662	(350)
0.125	E	Alloy 600	1600	(871)
0.125	S	Alloy 600	2150	(1177)
0.125	J	304 SS/316 SS	1500	(816)
0.125	K	304 SS	1600	(871)
0.250	K or N	Alloy 600	2150	(1177)
0.250	J	304 SS/310 SS/316 SS	1500	(816)
0.250	K	304 SS	1600	(871)
0.250	T	304 SS	662	(350)
0.250	E	304 SS/316 SS	1600	(871)
0.250	K	310 SS	2000	(1093)
0.250	K	316 SS	1600	(871)
0.250	T	316 SS	662	(350)
0.250	K	446 SS	2100	(1149)

# Thermocouples

## General Information

### Junction Types

Generally, the **grounded junction** offers the best compromise between performance and reliability. It is the best choice for general purpose measurements.

Select an **ungrounded junction** if the lead wire will be shielded and attached to the sheath. Also, select the ungrounded junction to avoid ground loops between instruments, power supplies and the sensor.

Listed below are junction styles offered by Watlow.

### Exposed Junction



Thermocouple wires are butt welded, insulated and sealed against liquid or gas penetration. This junction style provides the fastest possible response time but leaves the thermocouple wires unprotected against corrosive or mechanical damage.

### Grounded Junction



The sheath and conductors are welded together, forming a completely sealed, integral junction. The grounded junction is recommended in the presence of liquids, moisture, gas or high pressure. The wire is protected from corrosive or erosive conditions. Response time with this style approaches that of the exposed junction.

### Ungrounded Junction

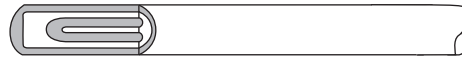

The thermocouple junction is fully insulated from the welded sheath end. The ungrounded junction is excellent for applications where stray EMFs would affect the reading and for frequent or rapid temperature cycling. Response time is longer than with the grounded junction.

### Ungrounded Dual Isolated Junction



Two separate thermocouples are encased in a single sheath. The isolation prevents ground loop errors if wired to separate instruments. Only available as ungrounded junctions.

# Thermocouples

## General Information

### Response Time

The smaller the diameter, the faster the thermocouple responds. Grounding the junction also improves response time by approximately 50 percent based on the sensor achieving 63.2 percent of the final reading or to the first time constant. It takes approximately five time constants to obtain steady state readings.

Temperature accuracy of the surrounding medium depends on the capability of the sensor to conduct heat from its outer sheath to the element wire.

Several factors come into play. Most commonly noted is "time constant" (thermal response time). Time constant, or thermal response time, is an expression of how quickly a sensor responds to temperature changes. As expressed here, time response is defined as the length of time it takes a sensor to reach 63.2 percent of a step temperature change (see graph to the right).

Response is a function of the mass of the sensor and its efficiency in transferring heat from its outer surfaces to the wire sensing element. A rapid time response is essential for accuracy in a system with sharp temperature changes. Time response varies with the probe's physical size and design.

Response times indicated represent standard industrial probes.

### Time Constant (Thermal Response Time)

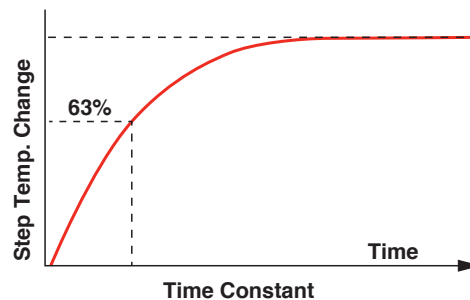

### Thermocouple Time Response

Sheath Diameter	Average Response Time Still Water (seconds)*	
	Grounded Junction	Ungrounded Junction
0.010 in.	<0.02	<0.02
0.020 in.	<0.02	0.03
0.032 in.	0.02	0.07
0.040 in.	0.04	0.13
0.063 in.	0.22	0.40
0.090 in.	0.33	0.68
0.125 in.	0.50	1.10
0.188 in.	1.00	2.30
0.250 in.	2.20	4.10
0.313 in.	5.00	7.00
0.375 in.	8.00	11.00
0.500 in.	15.00	20.00
0.5 mm	<0.02	0.03
1.0 mm	0.04	0.13
1.5 mm	<0.15	0.35
2.0 mm	0.25	0.55
3.0 mm	0.40	0.90
4.5 mm	0.95	2.00
6.0 mm	2.00	3.50
8.0 mm	5.00	7.00

\*Readings are to 63 percent of measured temperatures.

# Thermocouples

## General Information

### Thermocouple Resistance

Although resistance cannot confirm that the alloy meets the correct thermoelectric specifications, it checks for other undesirable characteristics such as opens, poor welds or wire corrosion. Always measure thermocouple resistance outside of the application to ensure that EMF output does not conflict with the resistance meter.

### Ohms per Double Feet

Long lead wire runs or use of analog-based instrumentation make conductor resistance an important factor when selecting the wire gauge best suited for an application. The table below lists nominal ohms per double feet for thermocouple and thermocouple extension wire. Ohms per double feet are the total resistance, in ohms, for both conductors, per foot.

### Nominal Resistance for Thermocouple Alloys in Ohms per Double Feet at 20°C

AWG Gauge	Calibration Type						
	Diameter in. (mm)	E	J	K	N	RX, SX	T
2	0.258 (6.543)	0.011	0.006	0.009	0.012		
4	0.204 (5.189)	0.017	0.009	0.014	0.019		
6	0.162 (4.115)	0.028	0.014	0.023	0.030		
8	0.129 (3.264)	0.044	0.023	0.036	0.048		
10	0.102 (2.588)	0.070	0.036	0.058	0.077		
12	0.081 (2.053)	0.111	0.057	0.092	0.123	0.006	0.048
14	0.064 (1.630)	0.177	0.091	0.147	0.195	0.010	0.076
16	0.051 (1.290)	0.281	0.145	0.233	0.310	0.016	0.120
18	0.040 (1.020)	0.453	0.234	0.376	0.500	0.025	0.194
20	0.032 (0.813)	0.709	0.367	0.589	0.783	0.040	0.304
22	0.025 (0.645)	1.129	0.584	0.937	1.245	0.063	0.483
24	0.020 (0.508)	1.795	0.928	1.490	1.980	0.100	0.768
26	0.016 (0.406)	2.853	1.476	2.369	3.148	0.159	1.221
28	0.013 (0.320)	4.537	2.347	3.767	5.006	0.253	1.942
30	0.010 (0.254)	7.214	3.731	5.990	7.960	0.402	3.088
32	0.008 (0.203)	11.470	5.933	9.524	12.656	0.639	4.910
34	0.006 (0.152)	18.239	9.434	15.145	20.126	1.016	7.808
36	0.005 (0.127)	29.000	15.000	24.080	32.000	1.615	12.415
14 Stranded	0.076 (1.930)	0.161	0.083	0.134	0.178	0.009	0.069
16 Stranded	0.060 (1.520)	0.256	0.133	0.213	0.283	0.014	0.110
18 Stranded	0.048 (1.220)	0.408	0.211	0.338	0.450	0.023	0.174
20 Stranded	0.038 (0.965)	0.648	0.335	0.538	0.715	0.036	0.277
22 Stranded	0.030 (0.762)	1.031	0.533	0.856	1.137	0.057	0.441
24 Stranded	0.024 (0.610)	1.639	0.848	1.361	1.808	0.091	0.701

**Note:** RX and SX indicate compensating thermocouple materials.

### Conductor Sizes

Wire Size AWG Gauge	Solid		Stranded		Number of Strands	Strand Gauge
	Diameter in. (mm)	Diameter in. (mm)	Diameter in. (mm)	Diameter in. (mm)		
14	0.064 (1.630)	0.076 (1.930)	7	22		
16	0.051 (1.290)	0.060 (1.520)	7	24		
18	0.040 (1.020)	0.048 (1.220)	7	26		
20	0.032 (0.813)	0.038 (0.965)	7	28		
22	0.025 (0.635)	0.030 (0.762)	7	30		
24	0.020 (0.508)	0.024 (0.610)	7	32		
26	0.016 (0.406)					
28	0.013 (0.330)					
30	0.010 (0.254)					
32	0.008 (0.203)					
34	0.006 (0.152)					
36	0.005 (0.127)					



# Thermocouples

## General Information

### How Do I Install a Sensor with Spring Loaded Bayonet Cap?

The bayonet adapter is used in conjunction with the spring loaded bayonet cap attached to the sensor sheath. The part to be measured is drilled and tapped for the installation of the bayonet adapter. After placing the

sensor through the adapter, the spring is compressed and locked with the bayonet cap. This allows the sensing zone to be pushed tightly against the surface for increased accuracy and faster response time.

"B" Dimension	Adapter Length				
	0.875	1	1.5	2	2.5
2.0	0.500	0.375	2	—	—
2.5	0.875	0.750	0.375	—	—
3.0	1.375	1.250	0.750	0.375	—
3.5	1.875	1.750	1.250	0.750	0.375
4.0	2.375	2.250	1.750	1.250	0.750
4.5	2.875	2.750	0.250	1.750	1.250
5.0	3.375	3.250	2.750	2.250	1.750
5.5	3.875	3.750	3.250	2.750	2.250
6.0	4.375	4.250	3.750	3.250	2.750
6.5	4.875	4.750	4.250	3.750	3.250
7.0	5.375	5.250	4.750	4.250	3.750
7.5	5.875	5.750	5.250	4.750	4.250
8.0	6.375	6.250	5.750	5.250	4.750
8.5	6.875	6.750	6.250	5.750	5.250
9.0	7.375	7.250	6.750	6.250	5.750
9.5	7.875	7.750	7.250	6.750	6.250
10.0	8.375	8.250	7.750	7.250	6.750
10.5	8.875	8.750	8.250	7.750	7.250
11.0	9.375	9.250	8.750	8.250	7.750
11.5	9.875	9.750	9.250	8.750	8.250
12.1	10.375	10.250	9.750	9.250	8.750

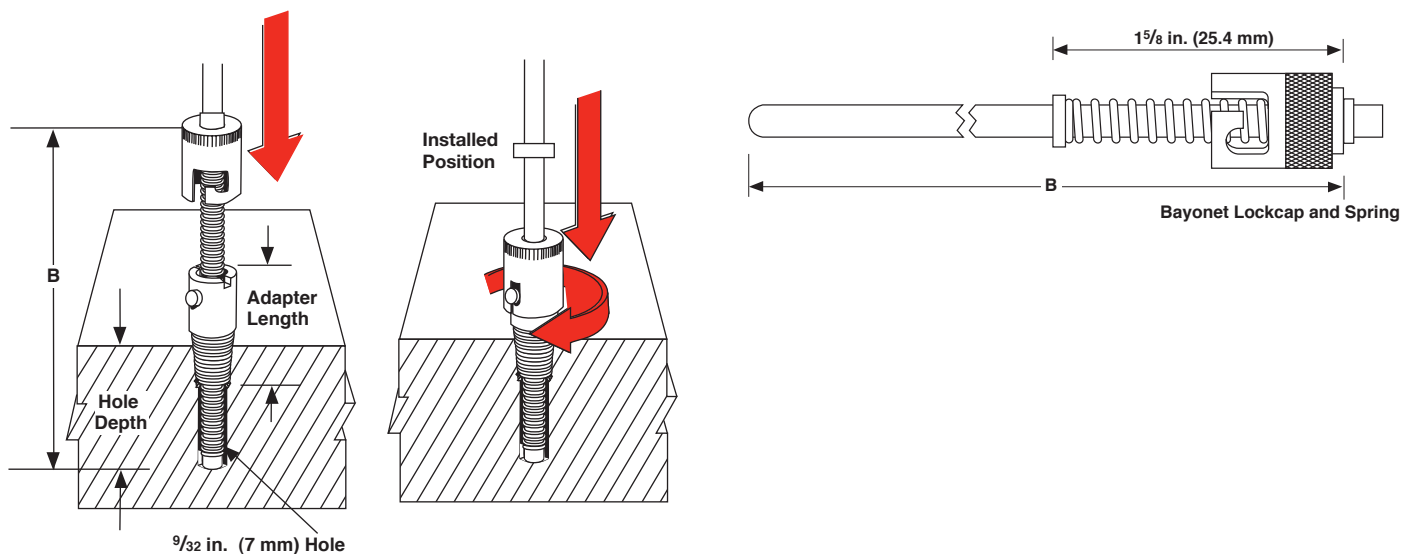

# Thermocouples

## General Applications Tube and Wire

Watlow® is a world class supplier of temperature measurement products, with more than 90 years of manufacturing, research and design expertise.

Companies engaged in critical process control of food and metals rely on Watlow thermocouples. Watlow designs and manufactures sensors to meet customers' industrial and commercial equipment needs.

Watlow has developed an extensive line of thermocouples to meet a broad range of sensing needs.

### Performance Capabilities

- Fiberglass insulated thermocouples can reach temperatures up to 900°F (480°C) for continuous operation.

### Features and Benefits

#### “Custom-tailored” standard products including:

- 32 standard sheath lengths
- Lead lengths from six to 360 inches
- Stainless steel braid or hose protection
- J, K, T and E calibrations
- Grounded, ungrounded and exposed junctions
- Flat and drill point
- Epoxy sealed cold ends
- Adjustable depths
- Flexible extensions
- Washers, nozzles and clamp bands
- Custom diameters
- PFA coated and stainless steel sheaths
- Straight, 45° bend or 90° bend
- Locking bayonet caps in standard, 12 mm and 15 mm

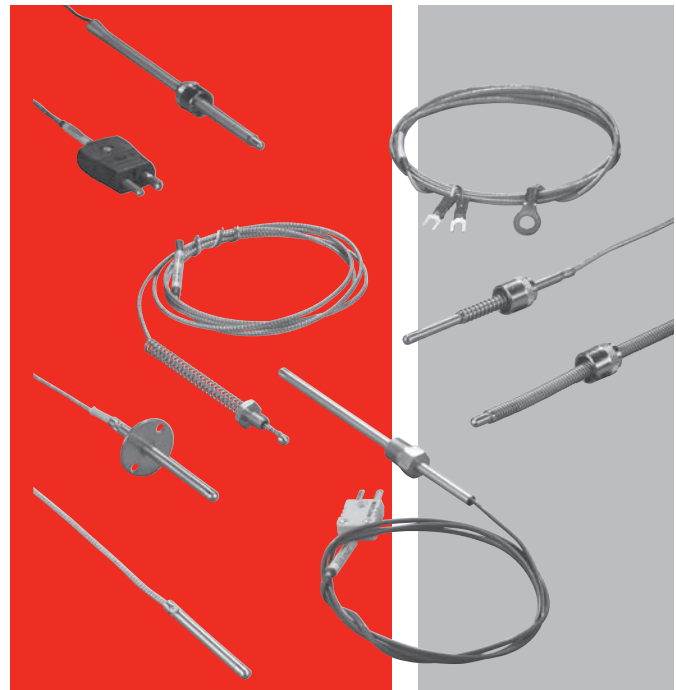

### Typical Applications

- Food processing equipment
- De-icing
- Plating baths
- Industrial processing
- Medical equipment
- Pipe tracing control
- Industrial heat treating
- Packaging equipment
- Liquid temperature measurement
- Refrigerator temperature control
- Oven temperature control

### Construction and Tolerances

Thermocouples feature flexible SERV-RITE® wire insulated with woven fiberglass or high temperature engineered resins. For added protection against abrasion, products can be provided with stainless steel wire braid and flexible armor. ASTM E230 color-coding identifies standard catalog thermocouple types.

The addition of a metal sheath over the thermocouple provides rigidity for accurate placement and added protection of the sensing junction. Mounting options include springs, ring terminals, specialized bolts, pipe style clamps and shims.

# Thermocouples



## General Applications Tube and Wire

### Bends

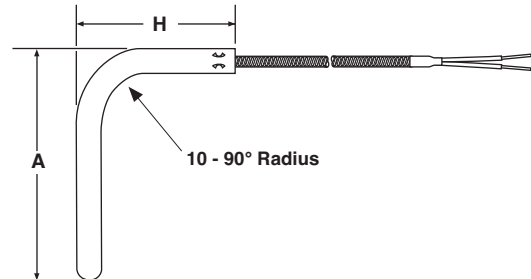
Diameter in.	Standard Bend Radius in.	Minimum "A" Dimension in.	Minimum "H" Dimension in.
0.125	3/8	1	2
0.188	3/8	1	2
0.250	1/2	2	2
0.375	3/4	3	2

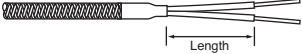
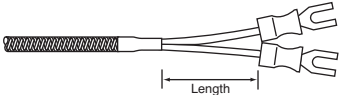
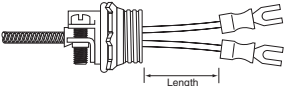
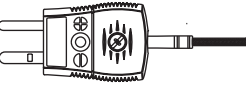
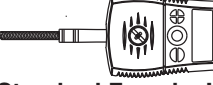
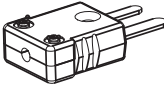

### Lead Terminations

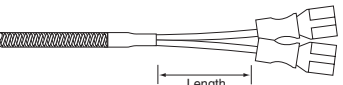
Termination	Code	Length
 <p>Split Leads</p>	A	2 1/2
 <p>#6 Spade Lugs</p>	B	2 1/2
 <p>#6 Spade Lugs and BX Connector</p>	C	2 1/2
 <p>Standard Male Plug</p>	D	—
 <p>Standard Female Jack</p>	E	—
 <p>Miniature Male Plug</p>	F	—
 <p>Miniature Female Jack</p>	G	—
 <p>1/4 inch Push-on Connectors</p>	H	2 1/2

# Thermocouples

## General Applications Tube and Wire

### Adjustable Spring Styles 10 and 11

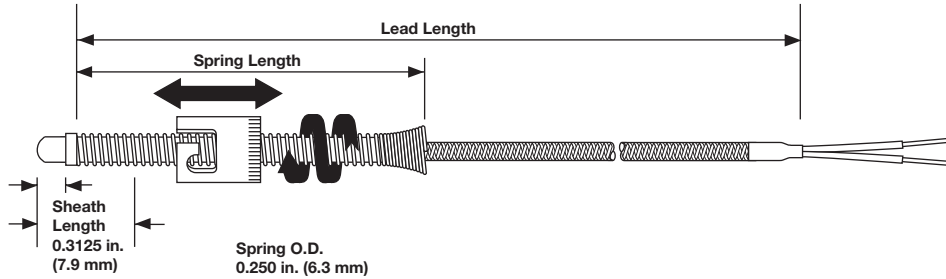

Adjustable spring style thermocouples bend to any angle to fit a wide range of hole depths, eliminating the need to stock numerous styles.

## Ordering Information

### Part Number

① ②	③	④	⑤	⑥	⑦	⑧ ⑨ ⑩	⑪
Const. Style	Sheath Diameter	Calibration	Lead Protection	Junction	Sheath Length	Lead Length	Term./Options
	D				B		

① ②	Construction Style
10 =	7/16 in. I.D. single slot (standard cap) - 6 in. spring
11 =	7/16 in. I.D. single slot (standard cap) - 12 in. spring

③	Sheath Diameter (in.) 316 SS
D =	3/16 in.

④	Calibration
J =	Type J
K =	Type K
T =	Type T
E =	Type E

⑤	Lead Protection
F =	Fiberglass (24 gauge stranded)
S =	Fiberglass with stainless steel overbraid (24 gauge stranded)
P =	Fiberglass (20 gauge stranded)
B =	Fiberglass with stainless steel overbraid (20 gauge stranded)
T =	PFA (24 gauge stranded)
U =	PFA with stainless steel overbraid (24 gauge stranded)
V =	PFA (20 gauge stranded)
W =	PFA with stainless steel overbraid (20 gauge stranded)

⑥	Junction
F =	Grounded, flat tip
G =	Grounded, round tip
D =	Grounded, drill point
R =	Ungrounded, flat tip
U =	Ungrounded, round tip
P =	Ungrounded, drill point

⑦	Sheath Length (in.)
B =	1 in. (25 mm)

⑧ ⑨ ⑩	Lead Length (in.)
Available lengths: 006 to 360 in., over 360 in. contact factory	

⑪	Termination/Options
<b>Firmware, Overlays, Parameter Settings</b>	
A =	Standard, 2 1/2 in. split leads
B =	2 1/2 in. split leads with #6 spade lugs
C =	2 1/2 in. split leads with #6 spade lugs and BX connector
D =	Standard male plug, quick disconnect
E =	Standard female jack, quick disconnect
F =	Miniature male plug, quick disconnect
G =	Miniature female jack, quick disconnect
H =	1/4 in. push-on connector

# Thermocouples

## General Applications Tube and Wire

### Adjustable Armor Style 12

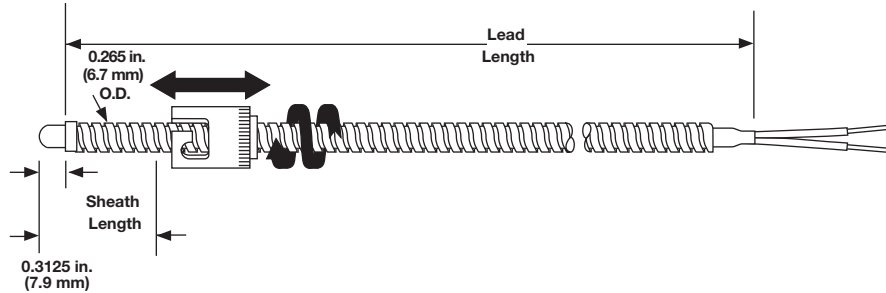

Adjustable armor thermocouples bend to any angle to fit a wide range of hole depths, eliminating the need to stock numerous styles. A stainless steel hose offers additional lead protection in demanding applications.

### Ordering Information

#### Part Number

① ②	③	④	⑤	⑥	⑦	⑧ ⑨ ⑩	⑪
Const. Style	Sheath Diameter	Calibration	Lead Protection	Junction	Sheath Length	Lead Length	Term./Options
12	D				B		

① ②	Construction Style
12 =	Adjustable armor thermocouple, 7/16 in. I.D. single slot (standard cap)

③	Sheath Diameter (in.) 316 SS
D =	3/16 in.

④	Calibration
J =	Type J
K =	Type K
T =	Type T
E =	Type E

⑤	Lead Protection
H =	Fiberglass with stainless steel flex hose (24 gauge stranded)
K =	PFA with stainless steel hose (24 gauge stranded)

⑥	Junction
F =	Grounded, flat tip
G =	Grounded, round tip
D =	Grounded, drill point
U =	Ungrounded, round tip
P =	Ungrounded, drill point
R =	Ungrounded, flat tip

⑦	Sheath Length (in.)
B =	1 in.

⑧ ⑨ ⑩	Lead Length (in.)
Available lengths: 006 to 360 in., over 360 in. contact factory	

⑪	Termination/Options
<b>Firmware, Overlays, Parameter Settings</b>	
A =	Standard, 2 1/2 in. split leads
B =	2 1/2 in. split leads with #6 spade lugs
C =	2 1/2 in. split leads with #6 spade lugs and BX connector
D =	Standard male plug, quick disconnect
E =	Standard female jack, quick disconnect
F =	Miniature male plug, quick disconnect
G =	Miniature female jack, quick disconnect
H =	1/4 in. push-on connector

# Thermocouples

## General Applications Tube and Wire

### Rigid Sheath

#### Styles 20, 21 and 22

#### 1/8 and 3/16 inch Diameter

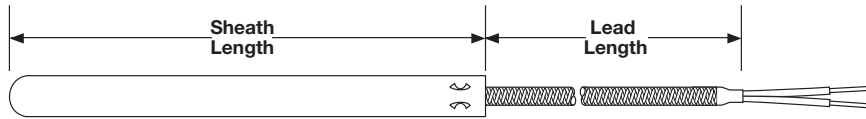

The rigid sheath provides protection and accurate placement through bulkheads or platens. Use with a compression fitting for water tight immersion application.

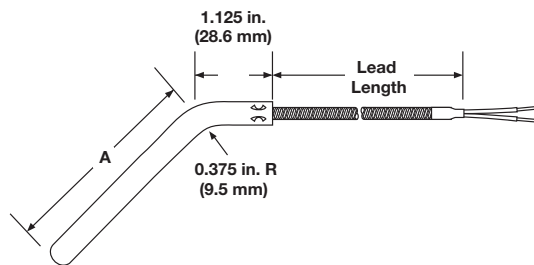
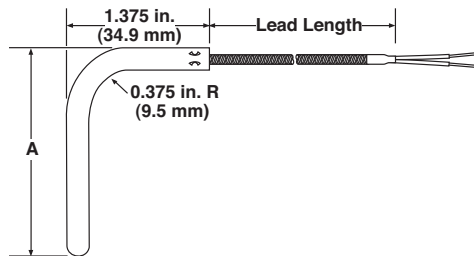

The bent rigid tube offers protection and accurate lead placement around machinery.

## Ordering Information

### Part Number

1 2	3	4	5	6	7	8 9 10	11
Const. Style	Sheath Diameter	Calibration	Lead Protection	Junction	Sheath Length	Lead Length	Term./Options

1 2	Construction Style
20 =	Plain sheath, straight
21 =	Plain sheath, 45° bend
22 =	Plain sheath, 90° bend

3	Sheath Diameter (in.) 316 SS
C =	1/8 in.
D =	3/16 in.
T =	3/16 in. epoxy sealed 300°F (149°C)

4	Calibration
J =	Type J
K =	Type K
T =	Type T
E =	Type E

5	Lead Protection
F =	Fiberglass (24 gauge stranded)
S =	Fiberglass with stainless steel overbraid (24 gauge stranded)
H =	Fiberglass with stainless steel hose (24 gauge stranded)
P* =	Fiberglass (20 gauge stranded)
B* =	Fiberglass with stainless steel overbraid (20 gauge stranded)
T =	PFA (24 gauge stranded)
U =	PFA with stainless steel overbraid (24 gauge stranded)
K =	PFA with stainless steel hose (24 gauge stranded)
V* =	PFA (20 gauge stranded)
W* =	PFA with stainless steel overbraid (20 gauge stranded)
* Not available with 1/8 in. diameter sheath.	

6	Junction
F =	Grounded, flat tip
G =	Grounded, round tip
D =	Grounded, drill point
R =	Ungrounded, flat tip
U =	Ungrounded, round tip
P =	Ungrounded, drill point
E =	Exposed

7	Sheath Length (in.)		
A* =	1/2 in.	J = 4 1/2 in.	S = 8 1/2 in.
B* =	1 in.	K = 5 in.	T = 9 in.
C =	1 1/2 in.	L = 5 1/2 in.	U = 9 1/2 in.
D =	2 in.	M = 6 in.	W = 10 in.
E =	2 1/2 in.	N = 6 1/2 in.	Y = 11 in.
F =	3 in.	P = 7 in.	Z = 12 in.
G =	3 1/2 in.	Q = 7 1/2 in.	
H =	4 in.	R = 8 in.	
* Not available in construction style 21 and 22.			

8 9 10	Lead Length (in.)
Available lengths: 006 to 360 in., over 360 in. contact factory	

11	Termination/Options
A =	Standard, 2 1/2 in. split leads
B =	2 1/2 in. split leads with #6 spade lugs
C =	2 1/2 in. split leads with #6 spade lugs and BX connector
D =	Standard male plug, quick disconnect
E =	Standard female jack, quick disconnect
F =	Miniature male plug, quick disconnect
G =	Miniature female jack, quick disconnect
H =	1/4 in. push-on connector

# Thermocouples

## General Applications Tube and Wire

### Rigid Sheath with Threaded Fitting

#### Styles 23 and 24

#### 1/8 and 3/16 inch Diameter

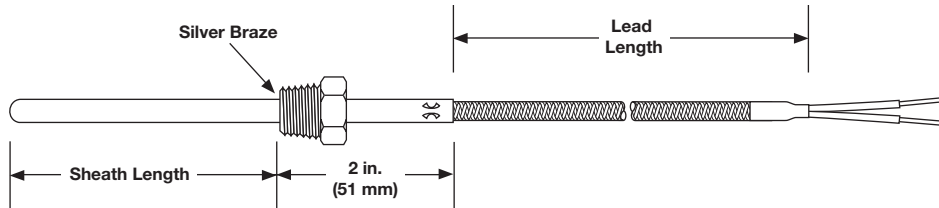

Rigid sheath with threaded fitting provides accurate placement in process applications.

## Ordering Information

### Part Number

1 2	3	4	5	6	7	8 9 10	11
Const. Style	Sheath Diameter	Calibration	Lead Protection	Junction	Sheath Length	Lead Length	Term./Options

1 2	Construction Style
23 =	Straight sheath with 1/8 in. National Pipe Thread (NPT) SS fitting
24 =	Straight sheath with 1/2 in. NPT SS fitting

3	Sheath Diameter (in.) 316 SS
C =	1/8 in.
D =	3/16 in.
T =	3/16 in. epoxy sealed 300°F (149°C)

4	Calibration
J =	Type J
K =	Type K
T =	Type T
E =	Type E

5	Lead Protection
F =	Fiberglass (24 gauge stranded)
S =	Fiberglass with stainless steel overbraid (24 gauge stranded)
H =	Fiberglass with stainless steel hose (24 gauge stranded)
P* =	Fiberglass (20 gauge stranded)
B* =	Fiberglass with stainless steel overbraid (20 gauge stranded)
T =	PFA (24 gauge stranded)
U =	PFA with stainless steel overbraid (24 gauge stranded)
K =	PFA with stainless steel hose (24 gauge stranded)
V* =	PFA (20 gauge stranded)
W* =	PFA with stainless steel overbraid (20 gauge stranded)

\* Not available with 1/8 in. diameter sheath.

6	Junction
F =	Grounded, flat tip
G =	Grounded, round tip
D =	Grounded, drill point
R =	Ungrounded, flat tip
U =	Ungrounded, round tip
P =	Ungrounded, drill point
E =	Exposed

7	Sheath Length (in.)				
A =	1/2 in.	J =	4 1/2 in.	S =	8 1/2 in.
B =	1 in.	K =	5 in.	T =	9 in.
C =	1 1/2 in.	L =	5 1/2 in.	U =	9 1/2 in.
D =	2 in.	M =	6 in.	W =	10 in.
E =	2 1/2 in.	N =	6 1/2 in.	Y =	11 in.
F =	3 in.	P =	7 in.	Z =	12 in.
G =	3 1/2 in.	Q =	7 1/2 in.		
H =	4 in.	R =	8 in.		

8 9 10	Lead Length (in.)
Available lengths: 006 to 360 in., over 360 in. contact factory	

11	Termination/Options
A =	Standard, 2 1/2 in. split leads
B =	2 1/2 in. split leads with #6 spade lugs
C =	2 1/2 in. split leads with #6 spade lugs and BX connector
D =	Standard male plug, quick disconnect
E =	Standard female jack, quick disconnect
F =	Miniature male plug, quick disconnect
G =	Miniature female jack, quick disconnect
H =	1/4 in. push-on connector

# Thermocouples

## General Applications Tube and Wire

### Flange Style 25

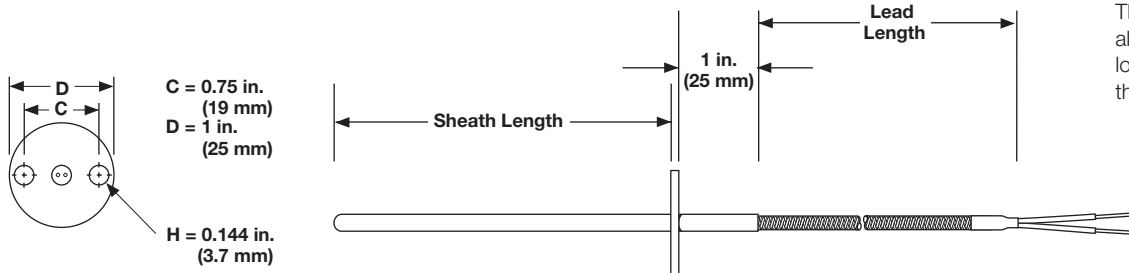

The flanged thermocouple allows rapid assembly and low profile when going through bulkheads.

## Ordering Information

### Part Number

1 2	3	4	5	6	7	8 9 10	11
Const. Style	Sheath Diameter	Calibration	Lead Protection	Junction	Sheath Length	Lead Length	Term./Options
25							

1 2	Construction Style
25	Thermocouple with flange

3	Sheath Diameter (in.) 316 SS
C =	1/8 in.
D =	3/16 in.
T =	3/16 in. epoxy sealed 300°F (149°C)

4	Calibration
J =	Type J
K =	Type K
T =	Type T
E =	Type E

5	Lead Protection
F =	Fiberglass (24 gauge stranded)
S =	Fiberglass with stainless steel overbraid (24 gauge stranded)
H =	Fiberglass with stainless steel hose (24 gauge stranded)
P* =	Fiberglass (20 gauge stranded)
B* =	Fiberglass with stainless steel overbraid (20 gauge stranded)
T =	PFA (24 gauge stranded)
U =	PFA with stainless steel overbraid (24 gauge stranded)
K =	PFA with stainless steel hose (24 gauge stranded)
V* =	PFA (20 gauge stranded)
W* =	PFA with stainless steel overbraid (20 gauge stranded)
* Not available with 1/8 in. diameter sheath.	

6	Junction
F =	Grounded, flat tip
G =	Grounded, round tip
D =	Grounded, drill point
R =	Ungrounded, flat tip
U =	Ungrounded, round tip
P =	Ungrounded, drill point
E =	Exposed
* Not available with 1/8 in. diameter sheath.	

7	Sheath Length (in.)				
D =	2 in.	L =	5 1/2 in.	T =	9 in.
E =	2 1/2 in.	M =	6 in.	U =	9 1/2 in.
F =	3 in.	N =	6 1/2 in.	W =	10 in.
G =	3 1/2 in.	P =	7 in.	Y =	11 in.
H =	4 in.	Q =	7 1/2 in.	Z =	12 in.
J =	4 1/2 in.	R =	8 in.		
K =	5 in.	S =	8 1/2 in.		

8 9 10	Lead Length (in.)
Available lengths: 006 to 360 in., over 360 in. contact factory	

11	Termination/Options
A =	Standard, 2 1/2 in. split leads
B =	2 1/2 in. split leads with #6 spade lugs
C =	2 1/2 in. split leads with #6 spade lugs and BX connector
D =	Standard male plug, quick disconnect
E =	Standard female jack, quick disconnect
F =	Miniature male plug, quick disconnect
G =	Miniature female jack, quick disconnect
H =	1/4 in. push-on connector



# Thermocouples

## General Applications Tube and Wire

### Rigid Sheath Styles 30, 31 and 32

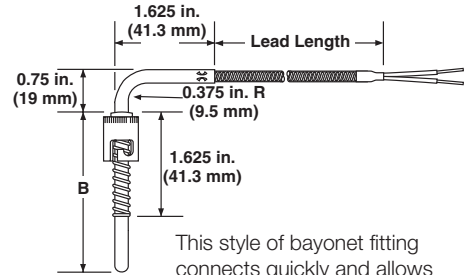
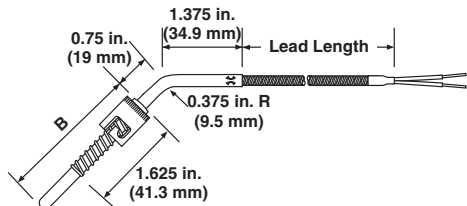
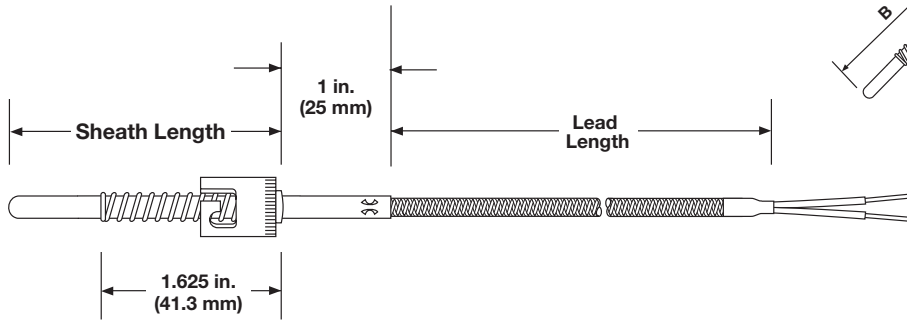

Bayonet fittings allow rapid attachment. Spring pressure on the junction tip assures fast response time.

This style of bayonet fitting connects quickly and allows leads to exit with a protective sheath.

## Ordering Information

### Part Number

1 2	3	4	5	6	7	8 9 10	11
Const. Style	Sheath Diameter	Calibration	Lead Protection	Junction	Sheath Length	Lead Length	Term./Options

1 2	Construction Style
30	$\frac{7}{16}$ in. I.D. single slot (standard cap) straight
31	$\frac{7}{16}$ in. I.D. single slot (standard cap) with spring, 45° bend
32	$\frac{7}{16}$ in. I.D. single slot (standard cap) with spring, 90° bend

3	Sheath Diameter (in.) 316 SS
C	$\frac{1}{8}$ in.
D	$\frac{3}{16}$ in.
T	$\frac{3}{16}$ in. epoxy sealed 300°F (149°C)

4	Calibration
J	Type J
K	Type K
T	Type T
E	Type E

5	Lead Protection
F	Fiberglass (24 gauge stranded)
S	Fiberglass with stainless steel overbraid (24 gauge stranded)
H	Fiberglass with stainless steel hose (24 gauge stranded)
P*	Fiberglass (20 gauge stranded)
B*	Fiberglass with stainless steel overbraid (20 gauge stranded)
T	PFA (24 gauge stranded)
U	PFA with stainless steel overbraid (24 gauge stranded)
K	PFA with stainless steel hose (24 gauge stranded)
V*	PFA (20 gauge stranded)
W*	PFA with stainless steel overbraid (20 gauge stranded)
* Not available with $\frac{1}{8}$ in. diameter sheath.	

6	Junction
F	Grounded, flat tip
G	Grounded, round tip
D	Grounded, drill point
R	Ungrounded, flat tip
U	Ungrounded, round tip
P	Ungrounded, drill point
E	Exposed

7	Sheath Length (in.)				
D	2 in.	L	5 1/2 in.	T	9 in.
E	2 1/2 in.	M	6 in.	U	9 1/2 in.
F	3 in.	N	6 1/2 in.	W	10 in.
G	3 1/2 in.	P	7 in.	Y	11 in.
H	4 in.	Q	7 1/2 in.	Z	12 in.
J	4 1/2 in.	R	8 in.		
K	5 in.	S	8 1/2 in.		

8 9 10	Lead Length (in.)
Available lengths: 006 to 360 in., over 360 in. contact factory	

11	Termination/Options
A	Standard, 2 1/2 in. split leads
B	2 1/2 in. split leads with #6 spade lugs
C	2 1/2 in. split leads with #6 spade lugs and BX connector
D	Standard male plug, quick disconnect
E	Standard female jack, quick disconnect
F	Miniature male plug, quick disconnect
G	Miniature female jack, quick disconnect
H	1/4 in. push-on connector

# Thermocouples

## General Applications Tube and Wire

### Large Diameter Rigid Sheath Styles 40, 41 and 42

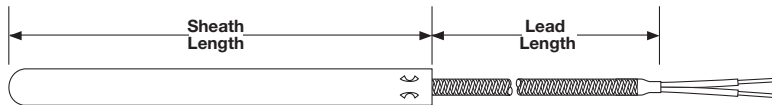

The rigid sheath provides protection and accurate placement through bulkheads or platens. Use with a compression fitting for water tight immersion application.

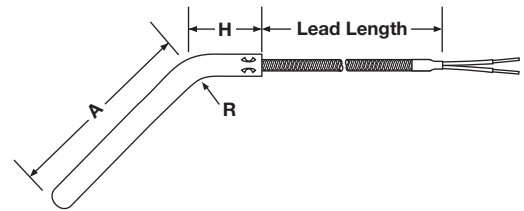

The bent rigid tube offers protection and accurate lead placement around machinery.

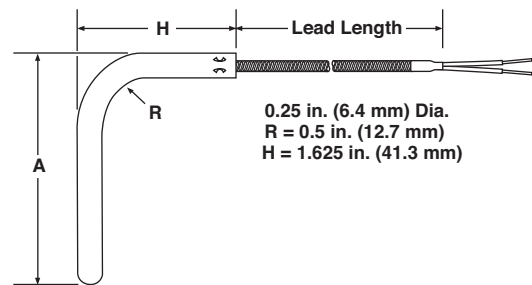

## Ordering Information

### Part Number

1	2	3	4	5	6	7	8	9	10	11
Const. Style	Sheath Diameter	Calibration	Lead Protection	Junction	Sheath Length	Lead Length	Lead Length			Term./Options

1	2	Construction Style
40	=	Plain sheath, straight, large, diameter
41	=	Plain (45°) large diameter
42	=	Plain (90°) large diameter

3	Sheath Diameter (in.) 316 SS
E	= 1/4 in.
U	= 1/4 in. epoxy sealed 300°F (149°C)

4	Calibration
J	= Type J
K	= Type K
T	= Type T
E	= Type E

5	Lead Protection
F	= Fiberglass (24 gauge stranded)
S	= Fiberglass with stainless steel overbraid (24 gauge stranded)
H	= Fiberglass with stainless steel hose (24 gauge stranded)
P	= Fiberglass (20 gauge stranded)
B	= Fiberglass with stainless steel overbraid (20 gauge stranded)
T	= PFA (24 gauge stranded)
U	= PFA with stainless steel overbraid (24 gauge stranded)
K	= PFA with stainless steel hose (24 gauge stranded)
V	= PFA (20 gauge stranded)
W	= PFA with stainless steel overbraid (20 gauge stranded)

6	Junction
F	= Grounded, flat tip
G	= Grounded, round tip
R	= Ungrounded, flat tip
U	= Ungrounded, round tip
E	= Exposed

7	Sheath Length (in.)				
A	= 1 in.	J	= 9 in.	S	= 17 in.
B	= 2 in.	K	= 10 in.	T	= 18 in.
C	= 3 in.	L	= 11 in.	U	= 19 in.
D	= 4 in.	M	= 12 in.	W	= 20 in.
E	= 5 in.	N	= 13 in.	Y	= 22 in.
F	= 6 in.	P	= 14 in.	Z	= 24 in.
G	= 7 in.	Q	= 15 in.		
H	= 8 in.	R	= 16 in.		

8	9	10	Lead Length (in.)
Available lengths: 006 to 360 in., over 360 in. contact factory			

11	Termination/Options
A	= Standard, 2 1/2 in. split leads
B	= 2 1/2 in. split leads with #6 spade lugs
C	= 2 1/2 in. split leads with #6 spade lugs and BX connector
D	= Standard male plug, quick disconnect
E	= Standard female jack, quick disconnect
F	= Miniature male plug, quick disconnect
G	= Miniature female jack, quick disconnect
H	= 1/4 in. push-on connector

# Thermocouples

## General Applications Tube and Wire

### Flexible Extensions Style 60

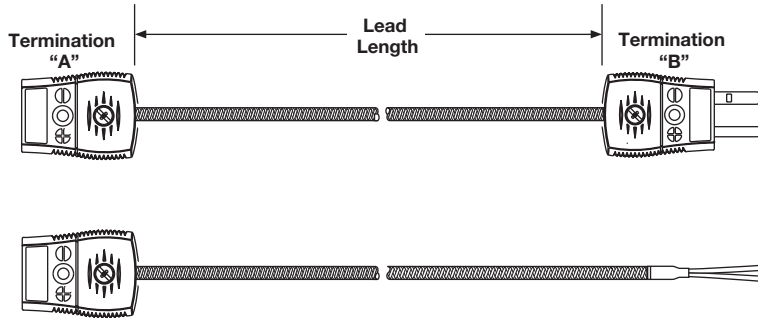

Flexible extensions allow thermocouples to be disconnected from a system without disturbing the remaining wiring.

## Ordering Information

### Part Number

1 2	3	4	5	6	7	8 9 10	11
Const. Style	Diameter	Calibration	Lead Protection	Junction	Term. "A"/Options	Lead Length	Term. B/Options
60	X			X			

1 2	Construction Style
60	Flexible extension

3	Diameter
X	Not applicable

4	Calibration
J	Type J
K	Type K
T	Type T
E	Type E

5	Lead Protection
F	Fiberglass (24 gauge stranded)
S	Fiberglass with stainless steel overbraid (24 gauge stranded)
H	Fiberglass with stainless steel hose (24 gauge stranded)
P	Fiberglass (20 gauge stranded)
B	Fiberglass with stainless steel overbraid (20 gauge stranded)
T	PFA (24 gauge stranded)
U	PFA with stainless steel overbraid (24 gauge stranded)
K	PFA with stainless steel hose (24 gauge stranded)
V	PFA (20 gauge stranded)
W	PFA with stainless steel overbraid (20 gauge stranded)

6	Junction
X	Not applicable

7	Termination "A"/Options
A	Standard, 2 <sup>1</sup> / <sub>2</sub> in. split leads
B	2 <sup>1</sup> / <sub>2</sub> in. split leads with spade lugs
C	2 <sup>1</sup> / <sub>2</sub> in. split leads with spade lugs and BX connector
D	Standard male plug, quick disconnect
E	Standard female jack, quick disconnect
F*	Miniature male plug, quick disconnect
G*	Miniature female jack, quick disconnect
H	1/4 in. push-on connector

\*Not available with SS hose.

8 9 10	Lead Length (in.)
	Available lengths: 006 to 360 in., over 360 in. contact factory

11	Termination "B"/Options
A	Standard, 2 <sup>1</sup> / <sub>2</sub> in. split leads
B	2 <sup>1</sup> / <sub>2</sub> in. split leads with #6 spade lugs
C	2 <sup>1</sup> / <sub>2</sub> in. split leads with #6 spade lugs and BX connector
D	Standard male plug, quick disconnect
E	Standard female jack, quick disconnect
F	Miniature male plug, quick disconnect
G	Miniature female jack, quick disconnect
H	1/4 in. push-on connector

# Thermocouples

## General Applications Tube and Wire

### Insulated Wire Styles 61 and 62

Constructed with SERV-RITE insulated thermocouple wire, Styles 61 and 62, are economical and versatile and can be ordered with an exposed or protected measuring junction. Style 61 is fitted with an exposed junction and is suitable for most general purpose applications, such

as measuring air, gas and surface temperatures. Style 62 is fitted with an encapsulated measuring junction that is ideal for corrosive fluids and gases, such as sulfuric acid, hydrofluoric acid, strong mineral acids and oils.

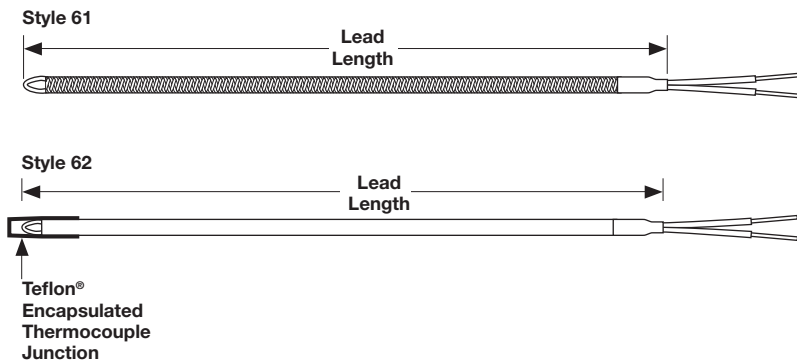

## Ordering Information

### Part Number

1	2	3	4	5	6	7	8	9	10	11
Const. Style	Diameter	Calibration	Lead Protection	Junction	Termination "A"	Lead Length	Term./Options			
	X			E	X					

1	2	Construction Style
61	=	SERIES 61
62*	=	SERIES 62
*Only available with wire (lead protection) options J or T (4th digit).		

3	Diameter
X	= Not applicable

4	Calibration
J	= Type J
K	= Type K
T	= Type T
E	= Type E

5	Lead Protection
P	= Fiberglass (20 gauge solid)
B	= Fiberglass with stainless steel overbraid (20 gauge solid)
F	= Fiberglass (24 gauge solid)
S	= Fiberglass with stainless steel overbraid (24 gauge solid)
T	= Extruded PFA (24 gauge solid)
J	= Extruded PFA (20 gauge solid)

6	Junction
E	= Exposed

8	9	10	Lead Length (in.)
Available lengths: 006 to 360 in., over 360 in. contact factory			

11	Termination/Options
A	= Standard, 2 1/2 in. split leads
B	= 2 1/2 in. split leads with spade lugs
C	= 2 1/2 in. split leads with #6 spade lugs and BX connector
D	= Standard male plug, quick disconnect
E	= Standard female jack, quick disconnect
F	= Miniature male plug, quick disconnect
G	= Miniature female jack, quick disconnect
H	= 1/4 in. push-on connector

# Thermocouples

## General Applications Tube and Wire

### Perfluoroalkoxy (PFA) Encapsulated Style 65

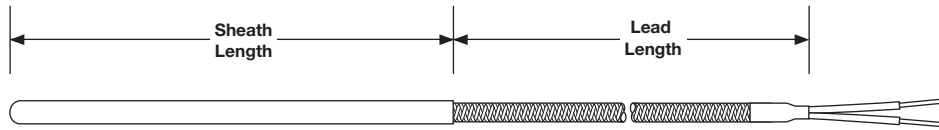

The rigid sheath is covered with a 0.010 in. (0.25 mm) wall of PFA for corrosion resistance in acid environments. An epoxy seal improves moisture resistance of the sensor and provides a barrier for migrating fumes in corrosive applications.

## Ordering Information

### Part Number

1 2	3	4	5	6	7	8 9 10	11
Const. Style	Diameter Under Covering	Calibration	Lead Protection	Junction	Sheath Length	Lead Length	Term./Options
65							

1 2	Construction Style
65 =	PFA coated sheath

3	Diameter (in.) Under Covering
D =	3/16 in. epoxy sealed 300°F (149°C)
E =	1/4 in. epoxy sealed 300°F (149°C)

4	Calibration
J =	Type J
K =	Type K
T =	Type T
E =	Type E

5	Lead Protection
T =	PFA (24 gauge stranded)
V =	PFA (20 gauge stranded)

6	Junction
U =	Ungrounded, round tip
G =	Grounded, round tip

7	Sheath Length (in.)		
B =	1 in.	J =	4 1/2 in.
C =	1 1/2 in.	K =	5 in.
D =	2 in.	L =	5 1/2 in.
E =	2 1/2 in.	M =	6 in.
F =	3 in.	N =	6 1/2 in.
G =	3 1/2 in.	P =	7 in.
H =	4 in.	Q =	7 1/2 in.
		R =	8 in.
		S =	8 1/2 in.
		T =	9 in.
		U =	9 1/2 in.
		W =	10 in.
		Y =	11 in.
		Z =	12 in.

8 9 10	Lead Length (in.)
Available lengths: 006 to 360 in., over 360 in. contact factory	

11	Termination/Options
A =	Standard, 2 1/2 in. split leads
B =	2 1/2 in. split leads with #6 spade lugs
C =	2 1/2 in. split leads with #6 spade lugs and BX connector
D =	Standard male plug, quick disconnect
E =	Standard female jack, quick disconnect
F =	Miniature male plug, quick disconnect
G =	Miniature female jack, quick disconnect
H =	1/4 in. push-on connector

# Thermocouples

## General Applications Tube and Wire

### Ring Terminal Style 70

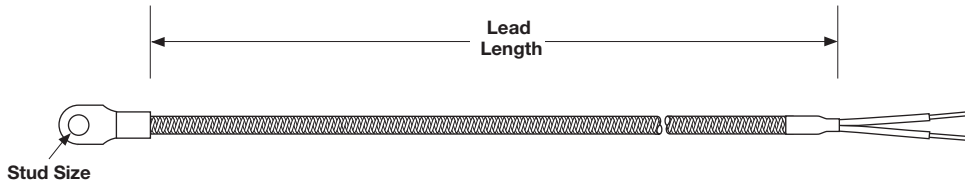

Stud Size

Note: Grounded junction shown.

The nickel terminal can be placed beneath existing screws or bolts to permit surface temperature measurement.

## Ordering Information

### Part Number

1 2	3	4	5	6	7	8 9 10	11
Const. Style	Diameter	Calibration	Lead Protection	Junction	Stud Size Hole Diameter	Lead Length	Term./Options
70	X						

1 2	Construction Style
70 =	Ring terminal thermocouple

3	Diameter
X =	Not applicable

4	Calibration
J =	Type J
K =	Type K
T =	Type T
E =	Type E

5	Lead Protection
F =	Fiberglass (24 gauge stranded)
S =	Fiberglass with stainless steel overbraid (24 gauge stranded)
P =	Fiberglass (20 gauge stranded)
B =	Fiberglass with stainless steel overbraid (20 gauge stranded)
T =	PFA (24 gauge stranded)
U =	PFA with stainless steel overbraid (24 gauge stranded)
V =	PFA (20 gauge stranded)
W =	PFA with stainless steel overbraid (20 gauge stranded)

6	Junction
G =	Grounded
U* =	Ungrounded
*Only available with 24 gauge wire.	

7	Stud Size - Hole Diameter (in.)
A* =	No. 6
B* =	No. 8
C* =	No. 10
D =	1/4
E =	3/8
*Only available with 24 gauge wire.	

8 9 10	Lead Length (in.)
Available lengths: 006 to 360 in., over 360 in. contact factory	

11	Termination/Options
A =	Standard, 2 1/2 in. split leads
B =	2 1/2 in. split leads with #6 spade lugs
C =	2 1/2 in. split leads with #6 spade lugs and BX connector
D =	Standard male plug, quick disconnect
E =	Standard female jack, quick disconnect
F =	Miniature male plug, quick disconnect
G =	Miniature female jack, quick disconnect
H =	1/4 in. push-on connector

# Thermocouples

## General Applications Tube and Wire

### Nozzle Style 71

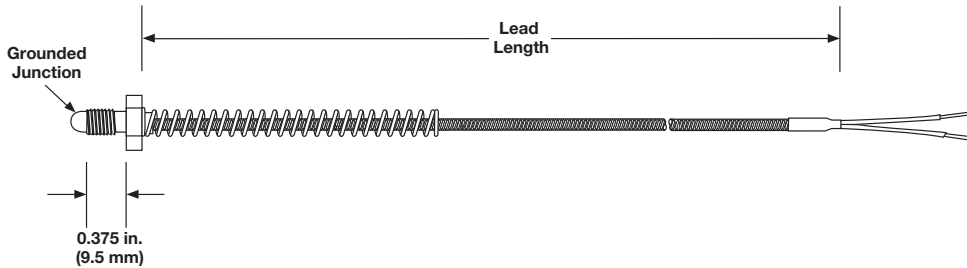

The nozzle thermocouple has a short installation depth and a low profile to allow control of thin platen sections.

## Ordering Information

### Part Number

1	2	3	4	5	6	7	8	9	10	11
Const. Style	Diameter	Calibration	Lead Protection	Junction	304 SS Bolt Size	Lead Length				Term./Options
71	X			G						

1	2	Construction Style
71		Nozzle thermocouple

3	Diameter
X	Not applicable

4	Calibration
J	Type J
K	Type K
T	Type T
E	Type E

5	Lead Protection
F	Fiberglass (24 gauge stranded)
S	Fiberglass with stainless steel overbraid (24 gauge stranded)
P*	Fiberglass (20 gauge stranded)
B*	Fiberglass with stainless steel overbraid (20 gauge stranded)
T	PFA (24 gauge stranded)
U	PFA with stainless steel overbraid (24 gauge stranded)
V*	PFA (20 gauge stranded)
W*	PFA with stainless steel overbraid (20 gauge stranded)

\*Not available with ungrounded junction.

6	Junction
G	Grounded
U	Ungrounded

7	304 SS, Bolt Size
A	1/4 in. x 28 UNF, 3/8 in. thread depth
B	8-32 thread
C	10-32 thread
M	M6 x 1

8	9	10	Lead Length (in.)
			Available lengths: 006 to 360 in., over 360 in. contact factory

11	Termination/Options
A	Standard, 2 1/2 in. split leads
B	2 1/2 in. split leads with #6 spade lugs
C	2 1/2 in. split leads with #6 spade lugs and BX connector
D	Standard male plug, quick disconnect
E	Standard female jack, quick disconnect
F	Miniature male plug, quick disconnect
G	Miniature female jack, quick disconnect
H	1/4 in. push-on connector

# Thermocouples

## General Applications Tube and Wire

### Pipe Clamp Style 72

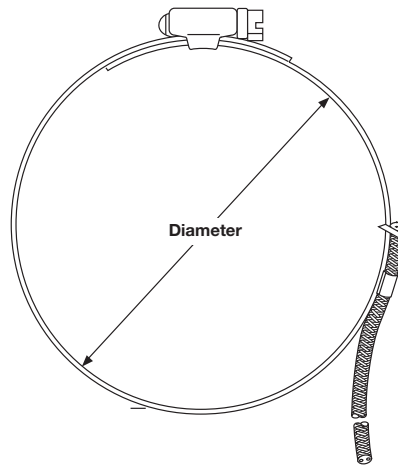
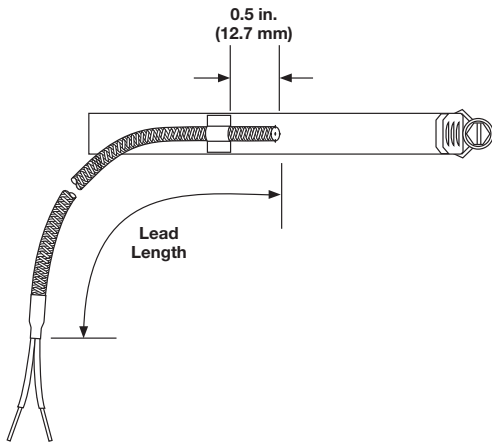

The stainless steel clamp allows temperature measurement without drilling or tapping which is ideal for measuring pipe temperatures.

## Ordering Information

### Part Number

1 2	3	4	5	6	7	8 9 10	11
Const. Style	Diameter	Calibration	Lead Protection	Junction	Clamp Band Dia. Range	Lead Length	Term./Options
72	X			G			

1 2	Construction Style
72 =	Pipe clamp thermocouple

3	Diameter
X =	Not applicable

4	Calibration
J =	Type J
K =	Type K
T =	Type T
E =	Type E

5	Lead Protection
S =	Fiberglass with stainless steel overbraid (24 gauge stranded)
B =	Fiberglass with stainless steel overbraid (20 gauge stranded)
U =	PFA with stainless steel overbraid (24 gauge stranded)
W =	PFA with stainless steel overbraid (20 gauge stranded)

6	Junction
G =	Grounded

7	Clamp Band Diameter Range (in.)
A =	$1^{11}/16$ to $1^{1}/4$
B =	$1^{1}/4$ to $2^{1}/4$
C =	$2^{1}/4$ to $3^{1}/4$
D =	$3^{1}/4$ to $4^{1}/4$
E =	$4^{1}/4$ to 5
F =	5 to 6
G =	6 to 7

8 9 10	Lead Length (in.)
Available lengths: 006 to 360 in., over 360 in. contact factory	

11	Termination/Options
A =	Standard, $2^{1}/2$ in. split leads
B =	$2^{1}/2$ in. split leads with #6 spade lugs
C =	$2^{1}/2$ in. split leads with #6 spade lugs and BX connector
D =	Standard male plug, quick disconnect
E =	Standard female jack, quick disconnect
F =	Miniature male plug, quick disconnect
G =	Miniature female jack, quick disconnect
H =	$1/4$ in. push-on connector



# Thermocouples

## General Applications Tube and Wire

### Grommet Style 73

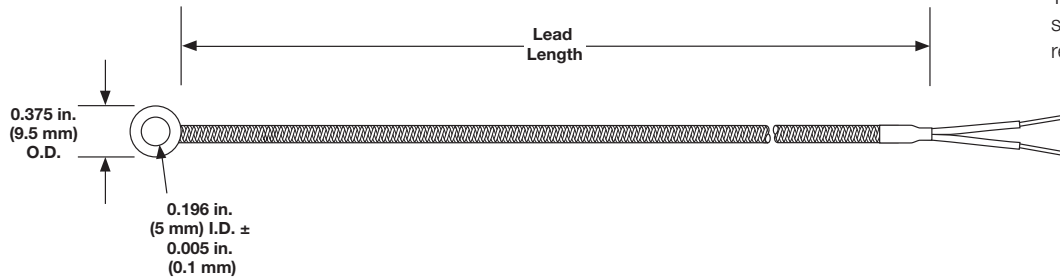

The extremely low profile of the stainless steel grommet provides fast response time.

## Ordering Information

### Part Number

1 2	3	4	5	6	7	8 9 10	11
Const. Style	Diameter	Calibration	Lead Protection	Junction	Grommet Size	Lead Length	Term./Options
73	X			G	A		

1 2	Construction Style
73 =	Grommet thermocouple

3	Diameter
X =	Not applicable

4	Calibration
J =	Type J
K =	Type K
T =	Type T
E =	Type E

5	Lead Protection
F =	Fiberglass (24 gauge solid)
T =	PFA (24 gauge solid)

6	Junction
G =	Grounded

7	Grommet Size (in.)
A =	0.195 in. I.D. x 0.375 in. O.D. x 0.035 in. thick

8 9 10	Lead Length (in.)
Available lengths: 006 to 360 in., over 360 in. contact factory	

11	Termination/Options
A =	Standard, 2 <sup>1</sup> / <sub>2</sub> in. split leads
B =	2 <sup>1</sup> / <sub>2</sub> in. split leads with #6 spade lugs
C =	2 <sup>1</sup> / <sub>2</sub> in. split leads with #6 spade lugs and BX connector
D =	Standard male plug, quick disconnect
E =	Standard female jack, quick disconnect
F =	Miniature male plug, quick disconnect
G =	Miniature female jack, quick disconnect
H =	1/4 in. push-on connector

# Thermocouples

## General Applications Tube and Wire

### Brass Shim Style 74

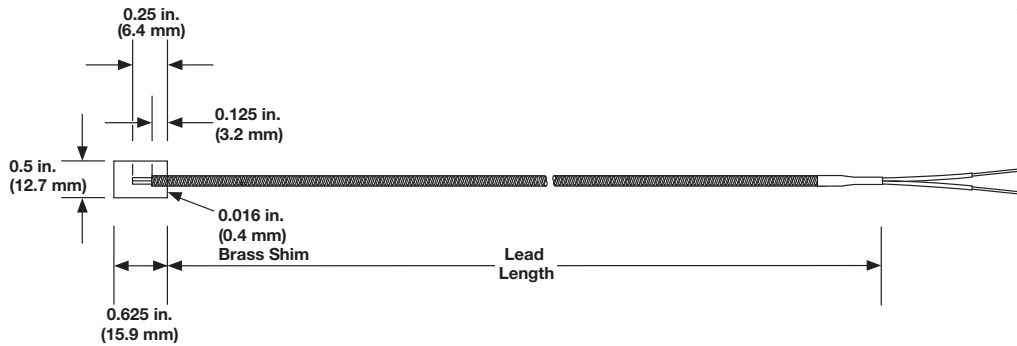

The shim stock thermocouple has a low profile and can be placed between components for surface temperature measurement.

## Ordering Information

### Part Number

① ②	③	④	⑤	⑥	⑦	⑧ ⑨ ⑩	⑪
Const. Style	Diameter	Calibration	Lead Protection	Junction	Shim Size	Lead Length	Term./Options
74	X			G	A		

① ②	Construction Style
74	Shim stock thermocouple

③	Diameter
X	Not applicable

④	Calibration
J	Type J
K	Type K
T	Type T
E	Type E

⑤	Lead Protection
F	Fiberglass (24 gauge solid)
T	PFA (24 gauge solid)

⑥	Junction
G	Grounded

⑦	Shim Size (in.)
A	$1/2 \times 5/8 \times 0.016$ in. brass

⑧ ⑨ ⑩	Lead Length (in.)
	Available lengths: 006 to 360 in., over 360 in. contact factory

⑪	Termination/Options
A	Standard, 2 <sup>1</sup> / <sub>2</sub> in. split leads
B	2 <sup>1</sup> / <sub>2</sub> in. split leads with #6 spade lugs
C	2 <sup>1</sup> / <sub>2</sub> in. split leads with #6 spade lugs and BX connector
D	Standard male plug, quick disconnect
E	Standard female jack, quick disconnect
F	Miniature male plug, quick disconnect
G	Miniature female jack, quick disconnect
H	1/4 in. push-on connector

# Thermocouples

## General Applications Tube and Wire

### Stainless Steel Shim Style 75

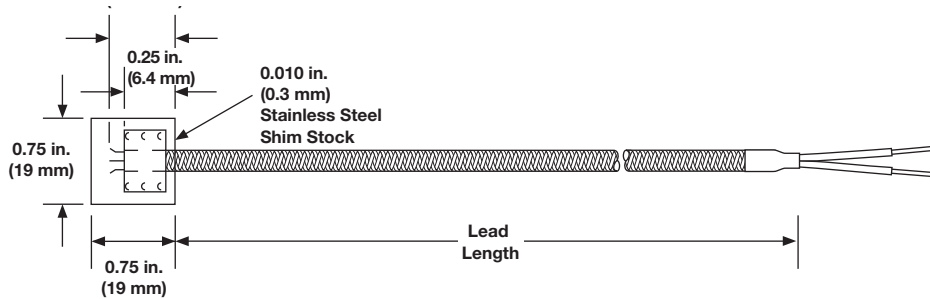

The shim stock thermocouple has a low profile and can be placed between components for surface temperature measurement.

## Ordering Information

### Part Number

① ②	③	④	⑤	⑥	⑦	⑧ ⑨ ⑩	⑪
Const. Style	Diameter	Calibration	Lead Protection	Junction	Shim Size	Lead Length	Term./Options
75	X			G	A		

① ②	Construction Style
75 =	Stainless steel shim stock thermocouple

③	Diameter
X =	Not applicable

④	Calibration
J =	Type J
K =	Type K

⑤	Lead Protection
F =	Fiberglass (24 gauge stranded)
S =	Fiberglass with stainless steel overbraid (24 gauge stranded)
T =	PFA (24 gauge stranded)
U =	PFA with stainless steel overbraid (24 gauge stranded)

⑥	Junction
G =	Grounded

⑦	Shim Size (in.)
A =	$\frac{3}{4} \times \frac{3}{4} \times 0.010$ in., 430 SS

⑧ ⑨ ⑩	Lead Length (in.)
	Available lengths: 006 to 360 in., over 360 in. contact factory

⑪	Termination/Options
A =	Standard, 2 $\frac{1}{2}$ in. split leads
B =	2 $\frac{1}{2}$ in. split leads with #6 spade lugs
C =	2 $\frac{1}{2}$ in. split leads with #6 spade lugs and BX connector
D =	Standard male plug, quick disconnect
E =	Standard female jack, quick disconnect
F =	Miniature male plug, quick disconnect
G =	Miniature female jack, quick disconnect
H =	$\frac{1}{4}$ in. push-on connector



# Thermocouples

## General Applications Tube and Wire

### Melt Bolt

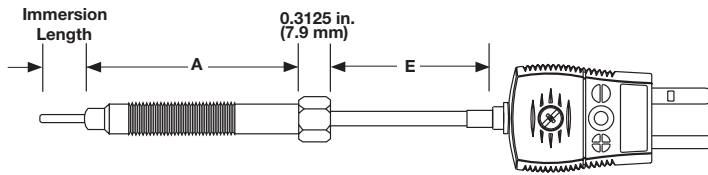

Fixed Immersion – Style M1

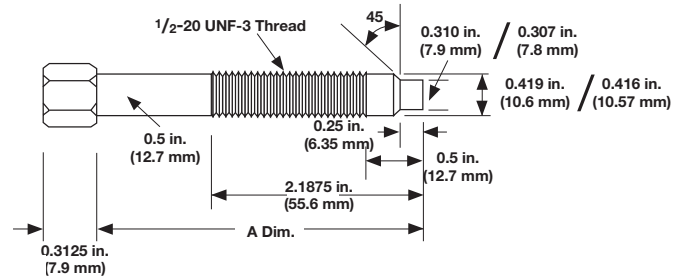

Standard Dimensions for Melt Bolts

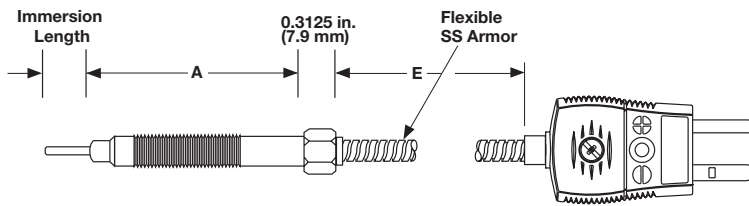

Fixed Immersion – Style M3

## Ordering Information

### Part Number

①	②	③	④	⑤	⑥	⑦	⑧	⑨	⑩	⑪	⑫	⑬ ⑭	⑮
	Style	Sheath O.D.	Lead Wire Const.	Melt Bolt Length "A"	Cold End Term.	Probe Const.		Imm. Length "I" (in.)	Imm. Length "I" (fract. in.)	Junction	Calibration	Extension Length "E"	
M						A	0						0

②	Style
1 =	Fixed immersion
3 =	Fixed immersion with flex armor

③	Sheath O.D. (in.)
G =	0.125

④	Lead Wire Construction
0 =	No flex armor (M1)
R =	SS flex armor (M3 only)

⑤	Melt Bolt Length "A" (in.)
1 =	3
2 =	6

⑥	Cold End Terminations
A =	Standard male plug
B =	Standard female jack
C =	Standard plug with mating connector
T =	Zero standard 1 1/2 in. split leads (Style M3 only)
U =	1 1/2 in. split leads with spade lugs (Style M3 only)
W =	1 1/2 in. split leads with BX connector and spade lugs (Style M3 only)

⑦	Probe Construction
A =	Mineral insulated with 304 SS sheath

⑨	Immersion Length "I" (in.)
1 =	1

⑩	Immersion Length "I" (fractional in.)
1 =	1/8
0 =	Flush

⑪	Junction
U =	Ungrounded
G =	Grounded

⑫	Calibration
J =	Standard limits
K =	Standard limits
3 =	Special limits
4 =	Special limits

⑬ ⑭	Extension Length "E"
	Whole inches: 02 to 99

# Thermocouples

## Mineral Insulated (MI)

Watlow's mineral insulated (MI) thermocouples are fast-responding, durable and capable of handling high temperatures.

Manufactured with best-in-class XACTPAK®, Watlow's trademark for metal sheathed, mineral insulated (MI) thermocouple material, XACTPAK responds fast because the protective metal outer sheath allows use of smaller diameter thermocouple conductors. The rock hard compacted MgO insulation further enhances the sensor's ability to "read" temperature by transferring heat quickly to the measuring junction.

The XACTPAK protecting sheath and compacted insulation outperform bare wire thermocouples in most applications.

### Performance Capabilities

- Easily handles temperatures up to 2200°F (1200°C)
- Meets or exceeds initial calibration tolerances per ASTM E 230

### Features and Benefits

#### Special mineral insulation

- Protects thermocouple from moisture and thermal shock
- Permits operation in high temperature, high pressure environments

#### Diameters as small as 0.020 in. (0.50 mm)

- Ideal when physical space or extremely fast response are critical

#### Flexibility of the XACTPAK material

- Allows forming and bending of the thermocouple, without risk of cracking, to meet design requirements

#### Outer sheath

- Protects wires from oxidation and hostile environments

#### Wide range of sheath materials, diameters and calibrations

- Meet specific requirements

#### In-house manufacturing of XACTPAK material

- Rigid quality control procedures
- Ensures high standards are met
- Single source reliability

#### Custom capabilities

- Include options such as special lead lengths, lead wires and terminations

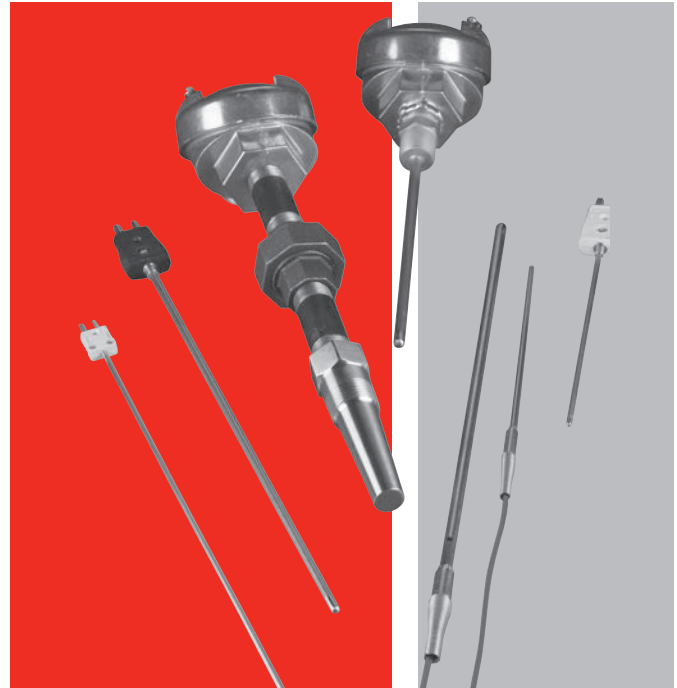

### Typical Applications

- Heat treating
- Furnaces/kilns
- Turbines
- Bearing temperature
- Power stations
- Steam generators
- Diesel engines
- Nuclear reactors
- Atomic research
- Jet engines and test cells
- Rocket engines
- Semiconductor manufacturing
- Refineries/oil processing
- Catalytic reformers
- Food processing

# Thermocouples



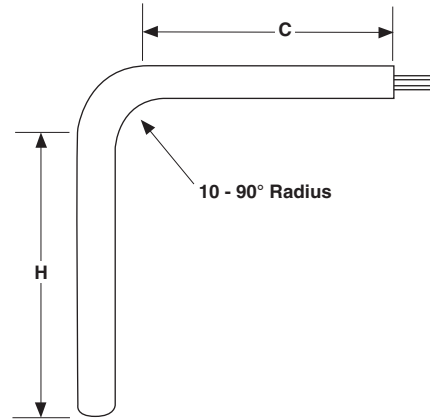

## Mineral Insulated

### Bends

Diameter in.	Standard Bend Radius in.	Minimum "H" Dimension in.	Minimum "C" Dimension in.
0.063	3/16	1/2	1 1/2
0.090	1/4	3/4	1 1/2
0.125	3/8	1	2
0.188	1/2	1	2
0.250	3/4	2	2
0.313	1 1/4	2	2
0.375	1 1/2	3	2
0.500	2	4	2

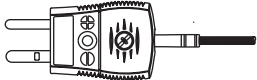
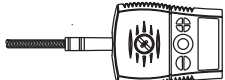
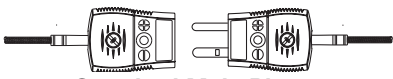

### Lead Terminations

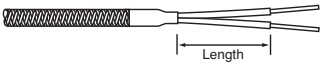
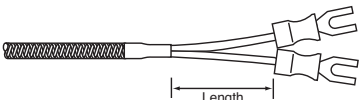
Termination	Code	Length
 <p>Standard Male Plug</p>	A	—
 <p>Standard Female Jack</p>	B	—
 <p>Standard Male Plug with Mating Connector</p>	C	—
 <p>Miniature Male Plug</p>	F	—
 <p>Miniature Female Jack</p>	G	—
 <p>Miniature Male Plug with Mating Connector</p>	H	—
 <p>Split Leads</p>	T	1 1/2
 <p>#8 Spade Lugs</p>	U	1 1/2

# Thermocouples



## Mineral Insulated

### Fitting Options

#### Fixed Fittings

Fitting Type	Material	Sheath Size in.	NPT Thread Size in.	Hex Size in.	Length in.	Code
 <p><b>Fixed Single Thread 1/8 NPT</b> Customer Specified</p>	303 SS	0.063 to 0.250	1/8	7/16	11/16	A
 <p><b>Fixed Single Thread 1/4 NPT</b> Customer Specified</p>	303 SS	0.125 to 0.250	1/4	9/16	7/8	B
 <p><b>Fixed Single Thread 1/2 NPT</b> Customer Specified</p>	303 SS	0.125 to 0.250	1/2	7/8	1	D
 <p><b>Fixed Double Thread 1/2 NPT</b> Customer Specified</p>	303 SS	0.125 to 0.250	1/2	7/8	1 <sup>3</sup> / <sub>4</sub>	F

#### Compression Fittings

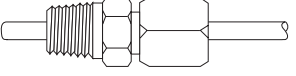
Fitting Type	Material	Sheath Size in.	NPT Thread Size in.	Hex Size in.	Length in.	Code
 <p><b>Non-Adjustable Compression Brass</b></p>	Brass	0.125	1/8	1/2	1	J
		0.188	1/8	1/2	1 <sup>1</sup> / <sub>8</sub>	J
		0.250	1/8	1/2	1 <sup>3</sup> / <sub>16</sub>	J
 <p><b>Non-Adjustable Compression SS</b></p>	303 SS	0.063	1/8	1/2	1 <sup>1</sup> / <sub>4</sub>	L
		0.125	1/8	1/2	1 <sup>1</sup> / <sub>4</sub>	L
		0.188	1/8	1/2	1 <sup>5</sup> / <sub>16</sub>	L
		0.250	1/8	1/2	1 <sup>5</sup> / <sub>16</sub>	L
 <p><b>Adjustable Compression TFE Gland</b></p>	303 SS	0.063	1/8	1/2	1 <sup>1</sup> / <sub>4</sub>	G
		0.125	1/8	1/2	1 <sup>1</sup> / <sub>4</sub>	G
		0.188	1/8	1/2	1 <sup>1</sup> / <sub>4</sub>	G
		0.250	1/4	7/8	2 <sup>7</sup> / <sub>16</sub>	X
 <p><b>Adjustable Compression Lava Gland</b></p>	303 SS	0.063	1/8	1/2	1 <sup>1</sup> / <sub>4</sub>	Q
		0.125	1/8	1/2	1 <sup>1</sup> / <sub>4</sub>	Q
		0.188	1/8	1/2	1 <sup>1</sup> / <sub>4</sub>	Q
		0.250	1/4	7/8	2 <sup>7</sup> / <sub>16</sub>	V

**Compression Fittings:** Compression fittings are shipped finger-tight on the sheath allowing field installation. Once non-adjustable fittings are deformed, they cannot be relocated. Adjustable fittings come with tetrafluorethylene (TFE) sealant or lava sealant glands.



# Thermocouples

## Mineral Insulated

### Fitting Options (Continued)

#### Adjustable Spring Loaded

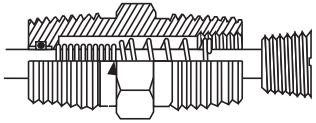
Fitting Type	Material	Sheath Size in.	NPT Thread Size in.	Hex Size in.	Length in.	Code
	316 SS	0.250	1/2	7/8	2	H

#### Bayonet Lockcap and Spring

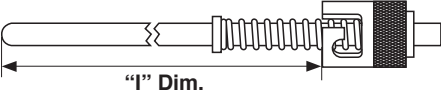
Fitting Type	Material	Sheath Size in.	Length in.	Code
	Plated Steel	0.125	1 <sup>5</sup> / <sub>8</sub>	W
	Plated Steel	0.188	1 <sup>5</sup> / <sub>8</sub>	W
	Plated Steel	0.063	1 <sup>5</sup> / <sub>8</sub>	W

#### Weld Pads

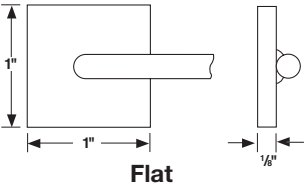
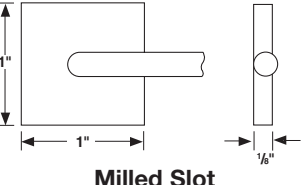
Weld Pad Type	Material	Code
 Flat	304 SS*	2
 Milled Slot	304 SS	5

\*Alloy 600 available on special order and recommended for use with alloy 600 sheath.

# Thermocouples

## Mineral Insulated

### Cut and Stripped Style AB

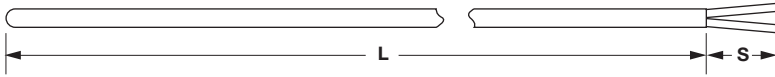

Watlow's Style AB thermocouple allows self termination of the thermocouple. Style AB is simply a section of XACTPAK material, junctioned and stripped and is the most basic of all the mineral insulated thermocouple styles.

Its XACTPAK mineral insulation construction protects the thermocouple from moisture, thermal shock, high temperatures and high pressure.

### Performance Capabilities

- Maximum temperature depends on sheath material, calibration and other variables

### Features and Benefits

#### Cold end stripped and sealed with epoxy

- Inhibits moisture penetration

#### Dual element style

- Allows two instruments to run from the same element, reducing costs

## Ordering Information

### Part Number

①	②	③	④	⑤	⑥	⑦	⑧ ⑨	⑩	⑪	⑫	⑬	⑭	⑮
A	B	Sheath O.D.	Special Options	Fittings, Weld Pads		Sheath Material	Sheath Length "L" (whole in.)	Sheath Length "L" (fract. in.)	Junction	Calibration	Strip Length "S" (whole in.)	Strip Length "S" (fract. in.)	
A	B				0								0

③ Sheath O.D. (in.)	
B =	0.020
C =	0.032
D =	0.040
E =	0.063
G =	0.125
H =	0.188
J =	0.250

④ Special Options	
0 =	No spring loaded and extension leads
1 =	Extension leads only
2 =	Spring loading hardware with extension leads

⑤ Fittings, Weld Pads	
0 =	None
<b>Notes:</b> If required, enter code from pages 54 to 55. If none, enter "0". Weld pads only available for 0.063 in. diameter and larger.	

⑦ Sheath Material	
A =	304/304L SS
C =	304/304L SS with Teflon® encapsulation
E =	316/316L SS with Teflon® encapsulation
F =	316/316L SS
Q =	Alloy 600 (Type K)

⑧ ⑨ Sheath Length "L" (whole in.)	
Available lengths: 01 to 99, for lengths over 99 inches contact factory	

⑩ Sheath Length (fractional in.)	
0 =	0
4 =	1/2

⑪ Junction			
	Grounded	Ungrounded	Exposed
Single	G	U	E
Dual*	H	W (isolated)	D (isolated)

\*Only available for 0.063 diameter in alloy 600.

⑫ Calibration				
	E	J	K	T
Standard limits	E	J	K	T
Special limits	2	3	4	8

⑬ Strip Length "S" (whole in.)	
0, 1, 2 and 3 - 1 in. max. on 0.040 and smaller	

⑭ Strip Length "S" (fractional in.)	
0 =	0
1 =	1/8
2 =	1/4
3 =	3/8
4 =	1/2
5 =	5/8
6 =	3/4
7 =	7/8

# Thermocouples

## Mineral Insulated

### Mini Plug or Jack Termination Style AC

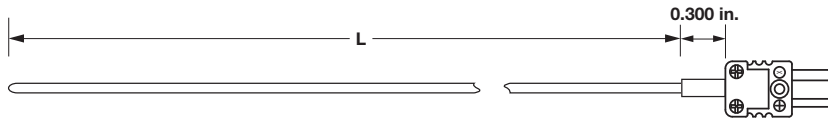

## Ordering Information

### Part Number

①	②	③	④	⑤	⑥	⑦	⑧ ⑨	⑩	⑪	⑫	⑬ ⑭	⑮
A	C	Sheath O.D.	Connector Type	Fittings, Weld Pads	0	Sheath Material	Sheath Length "L" (whole in.)	Sheath Length "L" (fract. in.)	Junction	Calibration	00	0

③ Sheath O.D. (in.)	
B =	0.020
C =	0.032
D =	0.040
E =	0.063
G =	0.125

④ Connector Type	
F =	Miniature plug
G =	Miniature jack
H =	Miniature plug with mating connector

**Note:** Miniature plugs and jacks 400°F (200°C) (0.125 in. max. O.D.).

⑤ Fittings, Weld Pads	
0 =	None

**Notes:** If required, enter code from pages 54 to 55. If none, enter "0."  
Weld pads only available for 0.063 in. and 0.125 in. diameters.

⑦ Sheath Material	
A =	304/304L SS
C =	PFA coated over 304/304L SS (available on G diameter)
E =	316/316L SS with Teflon® encapsulation
F =	316/316L SS
Q =	Alloy 600 (Type K)

⑧ ⑨ Sheath Length "L" (whole in.)	
Available lengths: 01 to 99, for lengths over 99 inches contact factory. Maximum length for PFA coating is 48 in.	

⑩ Sheath Length "L" (fractional in.)	
0 =	0
4 =	1/2

⑪ Junction			
	Grounded	Ungrounded	Exposed
Single	G	U	E

⑫ Calibration				
	E	J	K	T
Standard limits	E	J	K	T
Special limits	2	3	4	8

# Thermocouples

## Mineral Insulated

### Standard Plug or Jack Termination Style AC

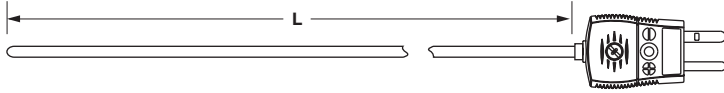

## Ordering Information

### Part Number

①	②	③	④	⑤	⑥	⑦	⑧ ⑨	⑩	⑪	⑫	⑬ ⑭	⑮
A	C	Sheath O.D.	Connector Type	Fittings, Weld Pads		Sheath Material	Sheath Length "L" (whole in.)	Sheath Length "L" (fract. in.)	Junction	Calibration		
A	C				0						00	0

③ Sheath O.D. (in.)	
D =	0.040
E =	0.063
G =	0.125
H =	0.188
J =	0.250

④ Connector Type	
A =	Standard plug
B =	Standard jack
C =	Standard plug with mating connector
<b>Note:</b> Standard plug and jacks 425°F (218°C).	

⑤ Fittings, Weld Pads	
0 =	None
<b>Notes:</b> Standard plug and jacks 425°F (218°C). Weld pads only available for 0.063 in. diameter and larger.	

⑦ Sheath Material	
A =	304/304L SS
F =	316/316L SS
C =	PFA coated over 304/304L SS (available on G, H, J diameters)
E =	316/316L SS with Teflon® encapsulation
Q =	Alloy 600 (Type K)

⑧ ⑨ Sheath Length "L" (whole in.)	
Available lengths: 01 to 99, for lengths over 99 inches contact factory. Maximum length for PFA coating is 48 in.	

⑩ Sheath Length "L" (fractional in.)	
0 =	0
4 =	1/2

⑪ Junction			
	Grounded	Ungrounded	Exposed
Single	G	U	E
Dual*	H	W (isolated)	D (isolated)
* Only available for 0.063 in. diameter and larger.			

⑫ Calibration				
	E	J	K	T
Standard limits	E	J	K	T
Special limits	2	3	4	8

# Thermocouples

## Mineral Insulated

### Metal Transitions with Spring Strain Relief Style AF

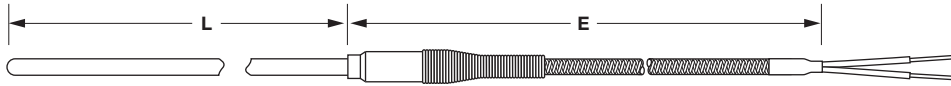

## Ordering Information

### Part Number

①	②	③	④	⑤	⑥	⑦	⑧ ⑨	⑩	⑪	⑫	⑬ ⑭	⑮
A	Style	Sheath O.D.	Lead Wire Const.	Fittings, Weld Pads	Lead Wire Term.	Sheath Material	Sheath Length "L" (whole in.)	Sheath Length "L" (fract. in.)	Junction	Calibration	Lead Wire Length "E" (whole ft)	Special Rqmts.
<b>A</b>	<b>F</b>											

②	Style
F =	Metal transition with strain relief and 300°F (149°C)

③	Sheath O.D. (in.)
B =	0.020
C =	0.032
D =	0.040
E =	0.063
G =	0.125
H =	0.188
J =	0.250

④	Lead Wire Construction			
		Standard	Overbraided	Flex Armor
Fiberglass	Solid	A	J	R
FEP	Solid	C	L	T
Fiberglass	Stranded*	B	K	S
FEP	Stranded*	D	M	U

\*Stranded lead wire available only for sheath O.D. 0.063 in. and larger.

⑤	Fittings, Weld Pads
0 =	None

**Notes:** If required, enter code from pages 54 to 55. If none, enter "0".  
Weld pads available for 0.063 in. and larger.

⑥	Lead Wire Termination
A =	Standard male plug
B =	Standard female jack
C =	Standard plug with mating connector
F =	Miniature male plug
G =	Miniature female jack
H =	Miniature plug with mating connector
T =	Standard, 1 1/2 in. split leads
U =	1 1/2 in. split leads with #8 spade lugs

⑦	Sheath Material
A =	304/304L SS
F =	316/316L SS
C =	PFA coated over 304/304L SS (available on G, H and J diameter)
E =	316/316L SS with Teflon® encapsulation
Q =	Alloy 600 (Type K)

⑧ ⑨	Sheath Length "L" (whole in.)
Available lengths: 01 to 99, for lengths over 99 inches contact factory. Maximum length for PFA coating is 48 in.	

⑩	Sheath Length "L" (fractional in.)
0 =	0
4 =	1/2

⑪	Junction		
	Grounded	Ungrounded	Exposed
Single	G	U	E
Dual*	H	W (isolated)	D (isolated)

\*Only available for 0.063 in. diameter and larger.

⑫	Calibration			
	E	J	K	T
Standard limits	E	J	K	T
Special limits	2	3	4	8

⑬ ⑭	Lead Wire Length "E" (whole feet)
Available lengths: 01 to 30, for lengths over 30 contact factory	

⑮	Special Requirements
0 =	Standard 300°F (149°C)
H =	High temperature 1000°F (538°C) potting
M =	500°F (260°C)

# Thermocouples

## Mineral Insulated

### Miniature Transitions Style AQ

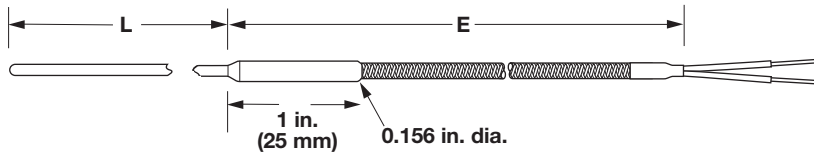

Note: 300°F (149°C) potting standard

## Ordering Information

### Part Number

①	②	③	④	⑤	⑥	⑦	⑧ ⑨	⑩	⑪	⑫	⑬ ⑭	⑮
	Style	Sheath O.D.	Lead Wire Const.		Lead Wire Term.	Sheath Material	Sheath Length "L" (whole in.)	Sheath Length "L" (fract. in.)	Junction	Calibration	Lead Wire Length "E" (whole ft)	Special Rqmts.
A	Q			0								

② Style	
Q =	Miniature metal transition with 300°F (149°C)

③ Sheath O.D. (in.)	
B =	0.020
C =	0.032
D =	0.040
E =	0.063

④ Lead Wire Construction	
A =	Fiberglass solid - 30 gauge
B =	Fiberglass solid - 24 gauge
C =	FEP solid - 30 gauge
D =	FEP solid - 24 gauge

⑥ Lead Wire Termination	
A =	Standard male plug
B =	Standard female jack
C =	Standard plug with mating connector
F =	Miniature male plug
G =	Miniature female jack
H =	Miniature plug with mating connector
T =	Standard, 1 1/2 in. split leads
U =	1 1/2 in. split leads with #8 spade lugs

⑦ Sheath Material	
A =	304/304L SS
F =	316/316L SS
Q =	Alloy 600 (Type K)

⑧ ⑨ Sheath Length "L" (whole in.)	
Available lengths: 01 to 99, for lengths over 99 inches contact factory	

⑩ Sheath Length "L" (fractional in.)	
0 =	0
4 =	1/2

⑪ Junction			
	Grounded	Ungrounded	Exposed
Single	G	U	E

⑫ Calibration		
	J	K
Standard limits	J	K
Special limits	3	4

⑬ ⑭ Lead Wire Length "E" (whole feet)	
Available lengths: 01 to 30	

⑮ Special Requirements	
0 =	Standard 300°F (149°C)
M =	500°F (260°C) potting

# Thermocouples

## Mineral Insulated

### Connection Head Style AR

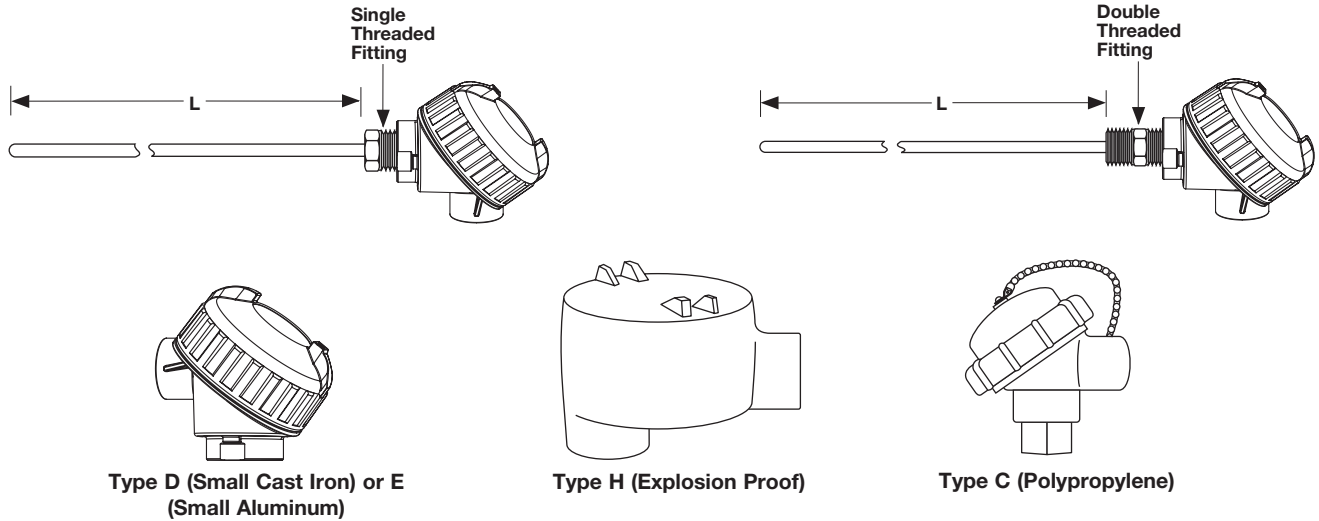

## Ordering Information

### Part Number

1	2	3	4	5	6	7	8	9	10	11	12	13	14	15
A	R	Sheath O.D. (in.)	Connection Head	Head Mounting Fittings	0	Sheath Material	Sheath Length "L" (whole in.)	Sheath Length "L" (fract. in.)	Junction	Calibration				
												00		0

3	Sheath O.D. (in.)
G =	0.125
H =	0.188
J =	0.250

4	Connection Head
C =	Polypropylene
D =	Small cast iron
E =	Small aluminum
H =	Explosion proof
U =	E head with 5750 transmitter*
V =	C head with 5750 transmitter*
W =	H head with 5750 transmitter*

\* For units with a transmitter, the order must specify a temperature range and °F or °C.

5	Head Mounting Fittings
0 =	Single threaded 303 SS
F =	Double threaded 303 SS 1/2 in. NPT
H* =	Spring loaded double threaded 316 SS 1/2 in. NPT

\*0.250 in. diameter only

7	Sheath Material
A =	304/304L SS
F =	316/316L SS
Q =	Alloy 600 (Type K)

8	9	Sheath Length "L" (whole in.)
Available lengths: 01 to 99, for lengths over 99 inches contact factory		

10	Sheath Length "L" (fractional in.)
0 =	0
1 =	1/8
2 =	1/4
3 =	3/8
4 =	1/2
5 =	5/8
6 =	3/4
7 =	7/8

11	Junction		
	Grounded	Ungrounded	Exposed
Single	G	U	E
Dual	H	W (isolated)	D (isolated)

12	Calibration			
	E	J	K	T
Standard limits	E	J	K	T
Special limits	2	3	4	8

# Thermocouples

## Mineral Insulated

### Wafer Head Style AS

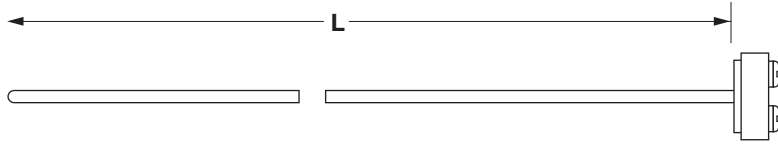

The Style AS thermocouple features a “wafer” head, which allows quick access to terminal screws for wiring. This thermocouple is an economical choice because the termination is attached directly to the XACTPAK sheath.

### Performance Capabilities

- Cold end termination temperature rating up to 1000°F (540°C)

### Features and Benefits

#### Termination directly to sheath

- Allows quick hookup and disassembly

#### Terminal head

- Available in a wide range of materials in both single and dual configurations

## Ordering Information

### Part Number

①	②	③ Sheath O.D. (in.)	④ Cold End Term.	⑤ Fittings, Weld Pads	⑥	⑦ Sheath Material	⑧ ⑨ Sheath Length “L” (whole in.)	⑩ Sheath Length “L” (fract. in.)	⑪ Junction	⑫ Calibration	⑬ ⑭	⑮
A	S		C		0						00	0

③ Sheath O.D. (in.)	
G =	0.125
H =	0.188
J =	0.250

④ Cold End Termination	
C =	Ceramic 1000°F (540°C), 1 <sup>1</sup> / <sub>8</sub> in. diameter x 5 <sup>5</sup> / <sub>8</sub> in. thick

⑤ Fittings, Weld Pads	
0 =	None
<b>Note:</b> If required, enter code from pages 54 to 55. If none, enter “0”.	

⑦ Sheath Material	
A =	304/304L SS
F =	316/316L SS
Q =	Alloy 600 (Type K)

⑧ ⑨ Sheath Length “L” (whole in.)	
Available lengths: 01 to 99, for lengths over 99 inches contact factory	

⑩ Sheath Length L (fractional in.)	
0 =	0
4 =	1/2

⑪ Junction			
	Grounded	Ungrounded	Exposed
Single	G	U	E
Dual	H	W (isolated)	D (isolated)

⑫ Calibration				
	E	J	K	T
Standard limits	E	J	K	T
Special limits	2	3	4	8



# Thermocouples

## Mineral Insulated

For Use With Thermowells  
Style AT

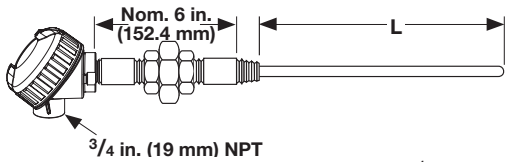

**Type 1** - 6 inch N-U-N typical (2 each 1/2 x 3 inch steel pipe nipples and 1 each malleable union)

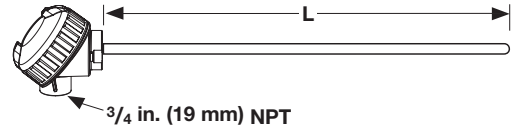

**Type 4** - Connection Head Only with 1/2 inch NPT process connection

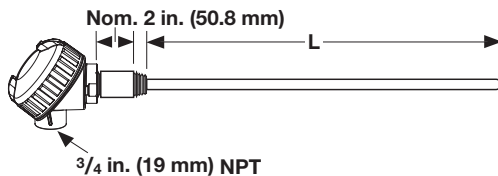

**Type 3** - 1/2 x 3 inch steel pipe nipple typical

## Ordering Information

### Part Number

1	2	3	4	5	6	7	8 9	10	11	12	13	14	15
		Sheath O.D. (in.)	Connection Head	Cold End Config.		Sheath Material	Sheath Length "L" (whole in.)	Sheath Length "L" (fract. in.)	Junction	Calibration		Spring-Loading	
A	T	J			0							0	0

3	Sheath O.D. (in.)
J =	0.250

4	Connection Head
C =	Polypropylene (1/2 in. NPT thermocouple opening only)
D =	Small cast iron
E =	Small aluminum
H =	Explosion proof (1/2 in. NPT and 3/4 in. NPT thermocouple opening only)

5	Cold End Configuration
1 =	Type 1, 6 in. nipple-union-nipple
3 =	Type 3, 3 in. nipple
4 =	Type 4, no extensions
<b>Note:</b> Steel nipple and unions are standard.	

7	Sheath Material
A =	304/304L SS
F =	316/316L SS
Q =	Alloy 600 (Type K)

8 9	Sheath Length "L" (whole in.)
Available lengths: 01 to 99, for lengths over 99 inches contact factory	

10	Sheath Length "L" (fractional in.)
0 =	0
1 =	1/8
2 =	1/4
3 =	3/8
4 =	1/2
5 =	5/8
6 =	3/4
7 =	7/8

11	Junction	
	Grounded	Ungrounded
Single	G	U
Dual	H	W (isolated)

12	Calibration			
	E	J	K	T
Standard limits	E	J	K	T
Special limits	2	3	4	8

14	Spring-Loading
Y =	Yes
N =	No

**Note:** For a complete sensor, add thermowell part number to the 15-digit AT part number. For sheath length, use "AR" (as required) and the factory will determine correct length.

# Thermocouples

EXTENDED  
CAPABILITY

## EXACTSENSE®

The EXACTSENSE® thermocouple from Watlow provides the accuracy, time response and durability required to help manufacturers improve the control of their diesel engine aftertreatment systems. The resulting benefits include more efficient regeneration, better fuel economy and improved emissions to meet the more stringent global requirements.

The EXACTSENSE thermocouple features integrated electronics within a molded connector housing. The electronics convert the thermocouple signal into either an analog or digital output signal that is compatible with the engine control module (ECM). Having a sensor with integrated electronics helps improve overall system accuracy and enables the use of information about the sensor such as part number, serial number, date of manufacture, time response, calibration, drift and more to enhance system performance or improve diagnostic capabilities.

The EXACTSENSE thermocouple includes WATCOUPLE™ sensing technology. This technology uses materials selected for their stability and longevity at high temperatures making this thermocouple an ideal choice for burner, flame and turbo applications. The durable mineral insulated thermocouple construction is also superior for applications requiring long immersion depths up to 7.9 in. (200 mm). The EXACTSENSE is point sensitive unlike RTDs, which average the temperature over the length of the element. These EXACTSENSE features provide the ability to accurately measure the temperature near the center of larger pipes without complex algorithms.

The mineral insulated construction also enables the tip to be tapered. This durable closed tip construction results in faster response times than competing sensor technologies can achieve with their less durable open tip constructions. EXACTSENSE tapered construction results in improved control and increased sensor life.

The EXACTSENSE thermocouple meets the demanding requirements for over-the-road medium and heavy-duty vehicles as well as on off-road equipment including construction, mining, agriculture, marine and locomotive. The EXACTSENSE thermocouple is available with a variety of standard options to meet specific manufacturer requirements.

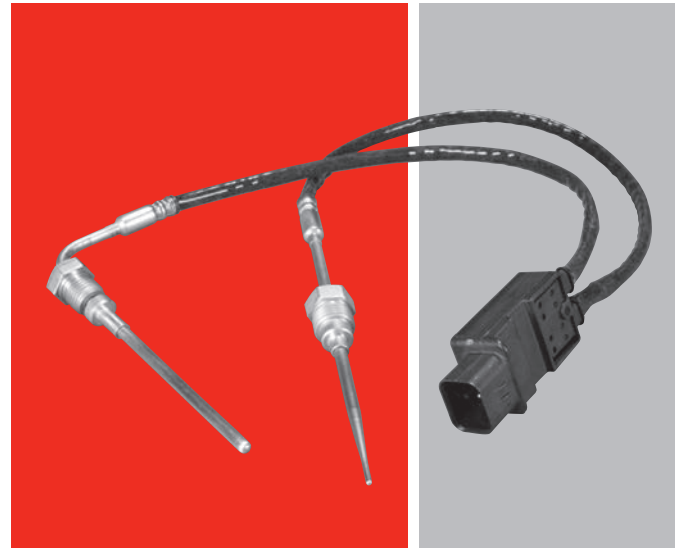

## Features and Benefits

### Integrated electronics

- Provide high system accuracy resulting in improved fuel economy
- Enable the availability of information for system performance monitoring and improved diagnostic capability
- Allow a variety of output signals compatible with ECMs

### WATCOUPLE thermocouple technology

- Provides reliability in rugged environments
- Operates at a wide range of temperatures
- Maximizes stability at high temperatures
- Provides longer sensor life

### Tapered tip construction

- Provides faster response time
- Increases life of sensors due to closed tip construction

### Long immersion depth

- Improves detection of actual process temperatures

## Typical Applications

- Diesel particulate filter (DPF)
- Diesel oxidation catalyst (DOC)
- Selective catalytic reduction (SCR)
- Exhaust gas recirculation (EGR)
- Lean NOx trap (LNT)
- Turbocharger
- Burner
- Reformer

## EXACTSENSE

### Specifications

#### Sensor Type

- Mineral insulated thermocouple

#### Output Options

- Analog 0 – 5V ratiometric analog voltage signal (RAVS)
- Analog 0 – 5V non-ratiometric analog voltage signal (AVS)
- LIN 2.1 or 1.3 compatible
- CAN J1939

#### Analog Supply Voltage (Vs1)

- 5V  $\pm$  0.25VDC

#### LIN Supply Voltage (Vs2)

- 9 to 17VDC

#### CAN Supply Voltage

- 6 to 16VDC

#### LIN Output Communication Speed

- 9600, 19200 baud rate
- LIN 2.1 or 1.3 compatible

#### CAN Output Communication Speed

- 250,000, 500,000 baud rate

#### Operating Temperature Range of Sensor

- -40 to 1382°F (-40 to 750°C) (stainless)
- -40 to 1832°F (-40 to 1000°C) (alloy 600)
- -40 to 2012°F (-40 to 1100°C) (Haynes® 230)

#### Analog Accuracy with Electronics

- $\pm$ 18°F ( $\pm$ 10°C) from -40 to 932°F (-40 to 500°C)
- $\pm$ 22.5°F ( $\pm$ 12.5°C) from 932 to 1832°F (500 to 1000°C)

#### LIN Accuracy with Electronics

- $\pm$ 14.4°F ( $\pm$ 8°C) from -40 to 2012°F (-40 to 1100°C)

#### CAN Accuracy with Electronics

- 12.6°F ( $\pm$ 7°C) from -40 to 1112°F (-40 to 600°C)

#### Response Time (T63) 0.08 in. (2.1 mm) Tip

- ~3 seconds in air moving at 70 meters/second

#### Response Time (T63) 0.16 in. (4.0 mm) Tip

- ~7 seconds in air moving at 70 meters/second

#### Immersion Depth (A Dimension)

- 0.98 to 7.87 in. (25 to 200 mm)

#### Operating Temperature Range of Electronics and Connector

- -40 to 248°F (-40 to 120°C)

#### Operating Temperature Range of Sensor to Wire Interface

- -40 to 392°F (-40 to 200°C)

#### Electromagnetic Interference (EMI), Radio Control Frequency (RFI)

- 100V/meter 20MHz to 2GHz

### Materials and Mounting

#### Sheath Materials

- 316 SS, alloy 600 or Haynes® 230

#### Mounting Fittings

- M12x1.5-6g, M14x1.5-6g and M16x1.5-6g, 400 SS

#### Lead Wire

- 0.96 mm<sup>2</sup> (18 AWG - 19 strands of 30 AWG) stranded wire with Tefzel® insulation

#### Protective Sleeve

- 392°F (200°C) silicone coated fiberglass sleeve (optional)

#### Connector

- Tyco Electronics 776488-1 (AMPSEAL 16 SERIES) with 2 rows of 2 gold plated pins
- Mating connector: Tyco plug 776487-1, Tyco S&F gold plated socket 776492-1, Tyco plug seal 776363-1

## EXACTSENSE

### Dimensional Drawings

#### Bent Probe (90°)

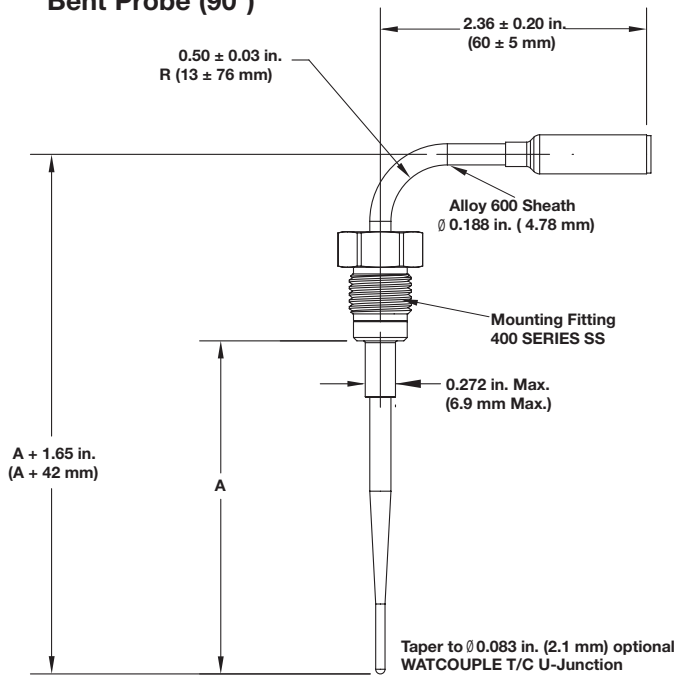

#### Assembly (Shown with Three Inputs)

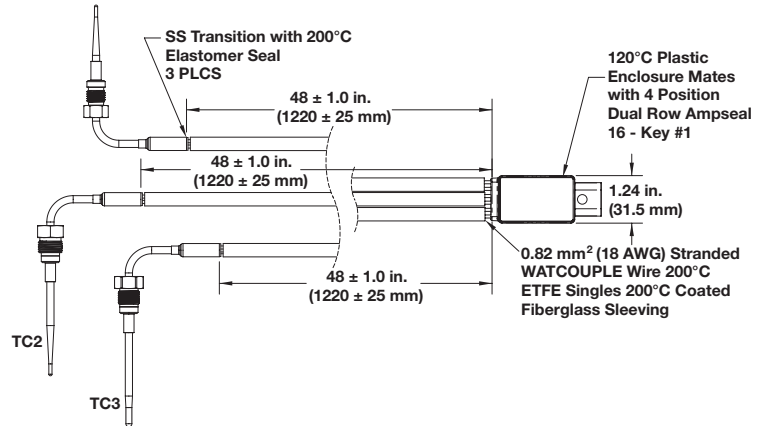

#### Electronic Housing

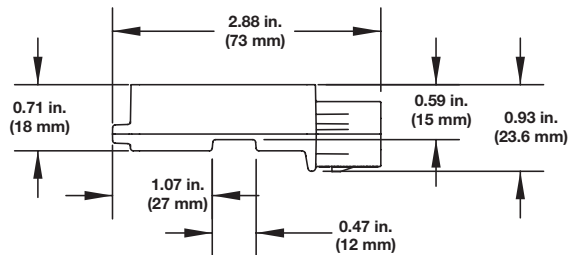

#### Straight Probe

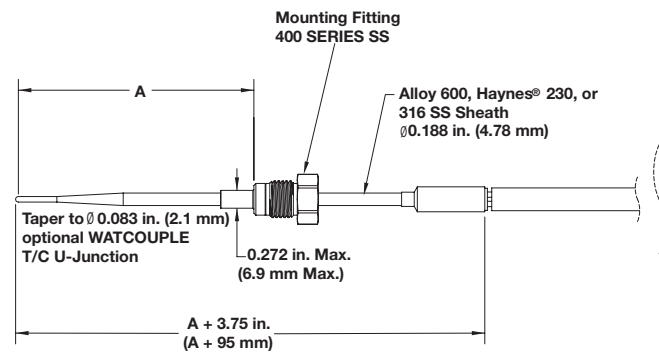

# Thermocouples

## Base Metal

Watlow offers two basic types of base metal thermocouples with protection tubes: bare and ceramic insulated elements. Many variations of each type are available to meet your application needs.

### Performance Capabilities

- 2300°F (1260°C) maximum temperature

### Features and Benefits

#### Insulated wire thermocouples

- Suitable for most general purpose applications

#### Bare and ceramic insulated elements

- Available in ASTM E 230 Types K and J can be twisted or butt welded
- Choices include straight or angle types, two- or four-hole insulators and single or dual element

#### Protected thermocouples

- Supplied complete with head, block and protection tube
- Several styles available

### Typical Applications

- Metal processing such as aluminum, zinc, brass (with appropriate protection tube)
- Chemical
- Petrochemical
- Industrial storage tanks

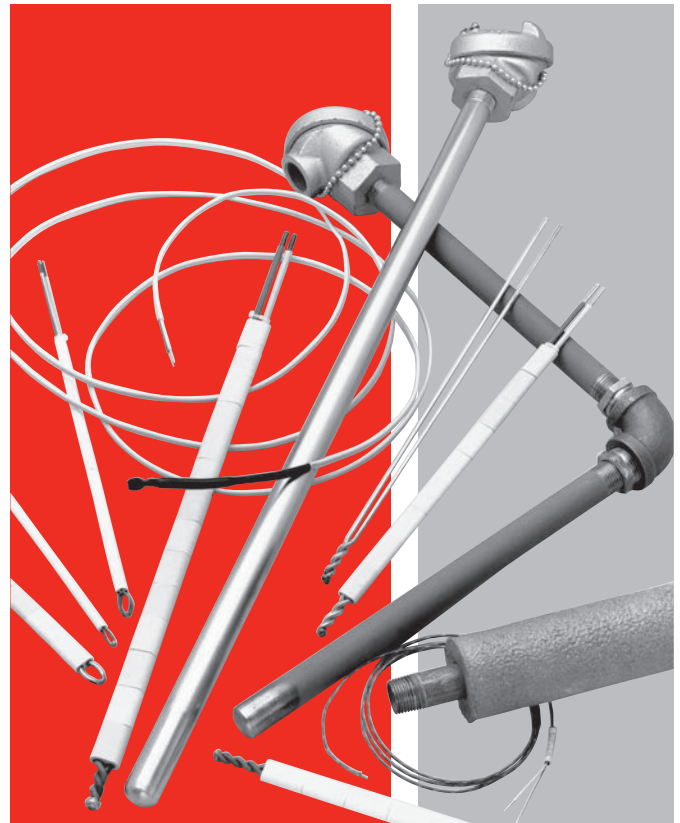

# Thermocouples

## Base Metal

### Bare Elements

To order, specify: Part number-length

Example: 1402-36 or 1432-BW-24

### Straight Elements with Two-Hole Insulators

To order, specify: Part number-length

Example: 1409-48 or 1436-BW-18

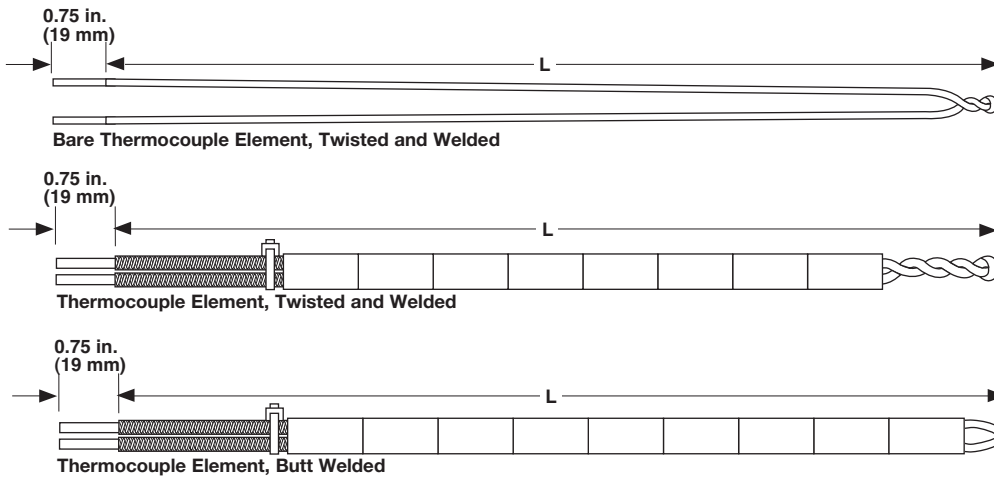

Part Number				AWG Gauge	Insulator Part No.	Length (in.)
Type K		Type J				
Twisted and Welded	Butt Welded	Twisted and Welded	Butt Welded			
1402	1432-BW	—	—	8	BARE	12, 18, 24, 30, 36, 42, 48, 54, 60, 66, 72
1403	1433-BW	—	—	11	BARE	
1404	1434-BW	1503	1576-BW	14	BARE	
1409	1436-BW	1507	1578-BW	8	301	
1410	1437-BW	—	—	11	304	
1411	1438-BW	1509	1579-BW	14	304	
1412	1439-BW	1510	1580-BW	20	328	

Note: For special limits, add -SP to part number, example (1409-12-SP)

### Angle Type with Two-Hole Insulators

To order, specify: Part number-cold leg length-hot leg length

Example: 1440-BW-12-24

Part Number		Insulator Part No. Hot and Cold Sections*	Hot Leg Length (in.)
Type K			
Butt Welded	AWG Gauge		
1440-BW	8	301	24, 30, 36, 42, 48, 54, 60

Note: For special limits, add -SP to part number, example (1440-BW-12-24-SP)

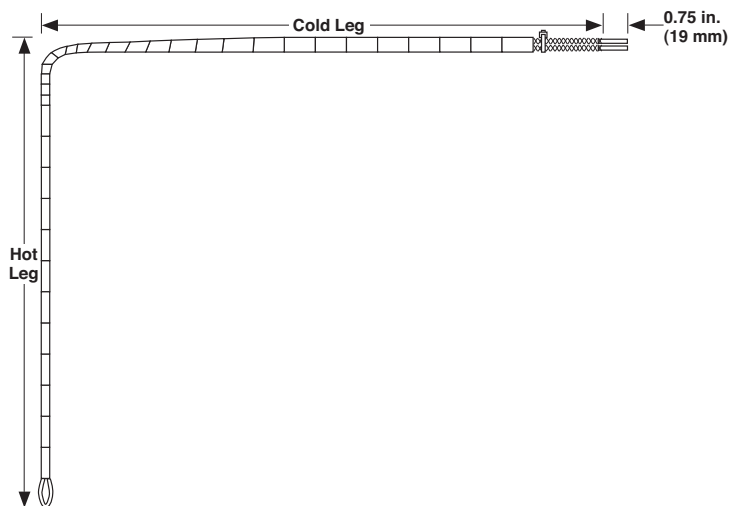

# Thermocouples

## Base Metal

### Dual Elements with Four-Hole Insulators

To order, specify: Part number-length

Example: 1442-BW-36

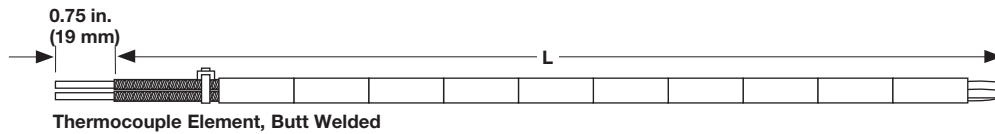

Part Number (Butt Welded Only)		AWG Gauge	Insulator Part No.	Length
Type K	Type J			
1442-BW	1584-BW	14	360	12, 18, 24, 30, 36, 42, 48
1443-BW	1585-BW	20	378	54, 60, 66, 72

Note: For special limits, add -SP to part number, example (1442-BW-12-SP)

### Standard Thermocouple with Protection Tubes

#### Straight Type

To order, specify: Part number-length

Example: 1409-1308-24

#### Metal Tube

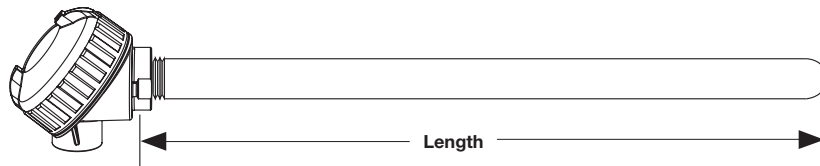

Part Number		AWG Gauge	Protection Tube		Pipe Diameter in.	Construction	Cast Iron Head	Length in.
Type K	Type J		Material	NPT Size in.				
1409-1395	1507-1395	8	Alloy 601	1/2	0.840	Seamless	70900203	12, 18, 24, 30, 36, 42, 48, 54, 60
1409-1396	1507-1396	8	Alloy 601	3/4	1.050	Seamless	70900202	
1409-1341	1507-1341	8	304 SS	1/2	0.840	Welded	70900203	
1409-1342	1507-1342	8	304 SS	3/4	1.050	Welded	70900202	
1409-1307	1507-1307	8	446 SS	1/2	0.840	Seamless	70900203	
1409-1308	1507-1308	8	446 SS	3/4	1.050	Seamless	70900202	
1409-1309	1507-1309	8	446 SS	1	1.315	Seamless	70900201	

Note: For special limits, add -SP to part number, example (1409-1395-12-SP)

# Thermocouples

## Base Metal

### Standard Thermocouple with Protection Tubes

#### 90 Degree Angle Type

**To order, specify:** Part number- cold leg length, hot leg length.  
Standard cold leg length is 18 inches.

**Example:** 1414-1395-18-24

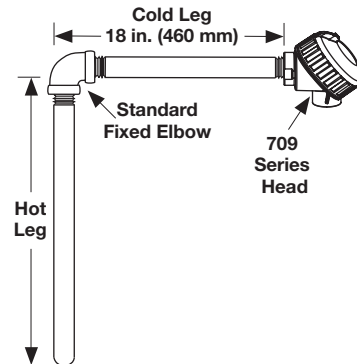

Part Number		AWG Gauge	Protection Tube		Construction	Cast Iron Head	Length in.
Type K	Type J		Material	NPT Size in.			
1414-1307-18	1517-1307-18	8	446 SS	1/2	Seamless	70900203	12, 18, 24, 30, 36
1414-1328-18	1517-1328-18	8	Black steel	1	Welded	70900201	
1414-1395-18	1517-1395-18	8	Alloy 601	1/2	Seamless	70900203	
1415-1307-18	1518-1307-18	14	446 SS	1/2	Seamless	70900203	
1415-1326-18	1518-1326-18	14	Black steel	1/2	Welded	70900203	
1415-1328-18	1518-1328-18	14	Black steel	1	Welded	70900201	
1415-1395-18	1518-1395-18	14	Alloy 601	1/2	Seamless	70900203	

#### Pipe Diameters

1/2 in. NPT = 0.840

3/4 in. NPT = 1.050

1 in. NPT = 1.315

**Note:** For special limits, add -SP to part number, example (1414-1395-18-24-SP)



# Thermocouples

## High Temperature

As a long time leader in the field of temperature measurement, Watlow continues to meet the demands of technological advances by developing thermocouples using materials with unusually high performance characteristics and superior quality.

Watlow's modern facilities are built to ensure that products meet compliance with today's complex specifications, standards and industrial or governmental regulatory requirements. Thermocouples are tested and certified to meet document compliance with agency standards—proof that Watlow products meet reliability and high performance standards.

### Performance Capabilities

- Compliance with recognized agency tolerances and specifications
- Temperature ranges up to 3100°F (1700°C)
- NIST traceable calibration certificates
- Thermocouple limits set to ITS-90 reference standards

### Features and Benefits

#### Thermocouple conductors

- Ideal for all temperature applications

#### Wide selection of sheath materials

- Meets specific application temperatures

#### Insulation materials

- Meets demanding application temperatures

#### Grounded and ungrounded junctions

- Meets electrical configurations

#### Testing and certification services

- Ideal for demanding applications

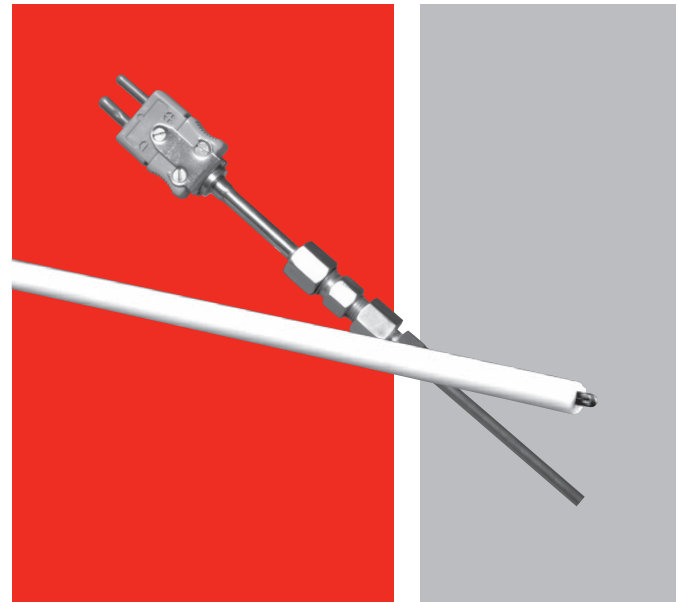

### Typical Applications

- Semiconductor: CVD processing, control spikes
- Diesel engines
- Jet engines
- Laboratory research
- Nuclear environments
- Power stations and steam generators
- Rocket engines
- Turbines
- Vacuum furnaces
- Exhaust gas sensing
- Glass manufacturing
- Heat treating and control sensors
- Ferrous and non-ferrous metals

# Thermocouples

## High Temperature

### Noble Metal

Watlow's noble metal thermocouples tolerate higher temperatures and provide greater accuracy than base metal thermocouples. Choose from ASTM E230 Types B, R or S, depending on temperature and tolerance requirements.

Thermocouples can be ordered as bare elements, elements with insulators or as assemblies. A typical assembly includes a head, alumina insulators and a protecting tube. A variety of hardware choices are available.

### Type B, R or S, 24 AWG

**To order, specify:** Part number-calibration-length

**Example:** 2114-R-24-MC

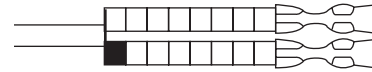

Enlarged picture of copper sleeves

For use with standard, general purpose heads; platinum assemblies can be furnished with MC-124 copper sleeves at no additional charge. Add the suffix "-MC" to part number.

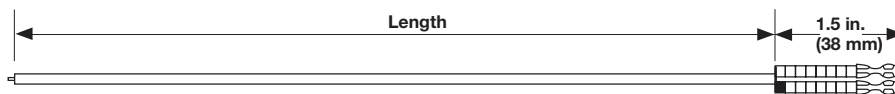

Elements with Insulators; Shown with Optional MC-124 Copper Sleeves

Calibration	Length in.	Part Number Bare T/C	Part Number T/C with Alumina Insulator*
B	12	2110-B-12	2114-B-12
	18	2110-B-18	2114-B-18
	24	2110-B-24	2114-B-24
	30	2110-B-30	2114-B-30
	36	2110-B-36	2114-B-36
	42	2110-B-42	2114-B-42
	48	2110-B-48	2114-B-48
R	12	2110-R-12	2114-R-12
	18	2110-R-18	2114-R-18
	24	2110-R-24	2114-R-24
	30	2110-R-30	2114-R-30
	36	2110-R-36	2114-R-36
	42	2110-R-42	2114-R-42
	48	2110-R-48	2114-R-48
S	12	2110-S-12	2114-S-12
	18	2110-S-18	2114-S-18
	24	2110-S-24	2114-S-24
	30	2110-S-30	2114-S-30
	36	2110-S-36	2114-S-36
	42	2110-S-42	2114-S-42
	48	2110-S-48	2114-S-48

\*Insulation consists of a one-piece two-hole alumina (0.125 diameter) insulator. For lengths over 24 in. (610 mm), a single piece alumina <sup>3</sup>/<sub>16</sub> inch diameter insulator is used.

# Thermocouples

## High Temperature

### Noble Metal

### Thermocouple Assemblies

**To order, specify:** Part number-calibration-length of tube

**Example:** 2144-S-24

2147-R-36

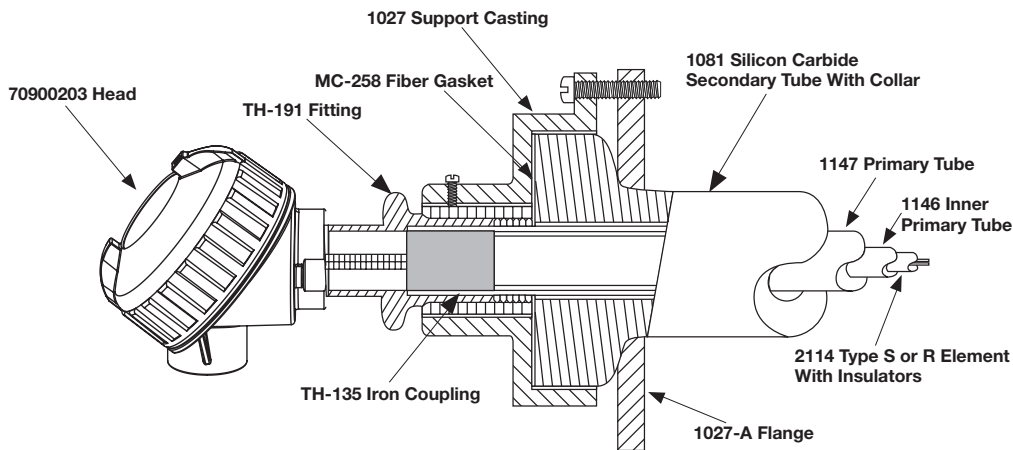

Typical Assembly with 70900203 Head

### 70900203 Head\* and Alumina Ceramics

Part Number*	Calibration	AWG Gauge	Protecting Tubes	Size I.D. x O.D. in.	Length in.
2144	B, R, S	24	1147 Alumina Primary only	7/16 x 11/16	12, 18, 24, 30, 36, 42, 48
2145	B, R, S	24	1147 Primary only 1146 Alumina Inner Primary	1/4 x 11/16	
2147	B, R, S	24	1147 Alumina Primary 1146 Alumina Inner Primary 1081 Secondary	1/4 x 13/4	

\*Specify Type B, R or S by adding -B, -R or -S after the part number. Types B, R and S thermocouples and the thermoelements are provided in accordance with ITS-90.

# Thermocouples

## High Temperature

### Exotic Metal Sheath

The specification tables shown on the following pages detail Watlow's highly specialized line of metal sheathed thermocouple configurations. Some combinations of noble or refractory metal sheaths, high temperature insulations and compatible thermocouple conductors can withstand temperatures as high as 3100°F (1700°C); others can be used in unusually corrosive environments. Pressure, atmosphere and other process variables all affect service life and operating maximums.

These sensors are constructed with hard-fired ceramic insulators strung onto the thermocouple conductors and inserted into the sheath with minimum practical clearance. This type of "loose pack" assembly cannot be bent or formed in the field. Contact the factory for special pre-bent sensors.

### High Temperature Insulation Materials

All of our most common exotic sheathed thermocouples are produced using hard-fired ceramic insulators strung onto the thermocouple conductors and inserted into the sheath with minimum practical clearance.

This type of "loose pack" assembly cannot be bent or formed in the field. Please contact the factory for special pre-bent assemblies.

Part Number	Insulation	Approximate Upper Useful Temperature	Approximate Melting Point	Remarks
<b>B</b>	Alumina Oxide (Al <sub>2</sub> O <sub>3</sub> ) (99.6% min. purity)	2800°F (1540°C)	3660°F (2015°C)	Comparable electrical properties to MgO. Used primarily in loose pack constructions because of availability and low cost.
<b>D</b>	Hafnia Oxide (HfO <sub>2</sub> )	4530°F (2500°C)	5000°F (2760°C)	Hafnia is replacing BeO in applications where BeO cannot be used because of safety concerns. Hafnia can be used up to 4530°F (2500°C)

### High Temperature Sheath Materials

Below is a table with our most common sheath materials.

Sheath Material	Approximate Melting Point	Max. Recommended Temperature	Environment	Available Constructions (in.)				Remarks
				0.063	0.125	0.188	0.250	
Molybdenum (mo)	4750°F (2620°C)	3450°F (1900°C)	Inert, vacuum, reducing	N/A	LP	N/A	N/A	Molybdenum is a refractory metal that is brittle and available in uncompact styles only. Do not use in oxidizing environments above 750°F (400°C). Vacuum at <10(-2) torr to 3100°F (1700°C). Vacuum <10(-4) torr to 3400°F (1870°C). Stable in inert gases to 3450°F (1900°C). Avoid contamination with graphite, carbon and hydrocarbons.
Alloy 600	2470°F (1345°C)	2150°F (1175°C)	Inert, vacuum, reducing, oxidizing	N/A	LP	N/A	LP	Maximum temperature 2150°F (1175°C). Most widely used thermocouple sheath material. Good high temperature strength, corrosion resistance, resistance to chloride ion stress corrosion cracking and oxidation resistance to high temperatures. Do not use in sulfur bearing environments. Good in nitriding environments.

# Thermocouples

## High Temperature

### Exotic Metal Sheath

#### High Temperature Sensing Wire

Calibration Type	Conductors	Approximate Upper Useful Temperature	Melting Point	Remarks
ASTM Type B	PT-30% Rh vs. Pt-6% Rh	3100°F (1700°C)	3250°F (1790°C)	Type B is composed of a positive leg (BP) which is approximately 70% platinum and 30% rhodium and a negative leg (BN) which is approximately 94% platinum and 6% rhodium. When protected by compacted mineral insulation and appropriate outer sheath, Type B is usable from 1600 to 3100°F (870 to 1700°C). Type B is available in standard limits and special limits ITS-90 scale.
ASTM Type R	PT-13% Rh vs. Pt	2700°F (1480°C)	3200°F (1760°C)	Type R is composed of a positive leg (RP) which is 87% platinum and 13% rhodium, and a negative leg (RN) which is 100% platinum. When protected by compacted mineral insulation and appropriate outer sheath, Type R is usable from 32 to 2700°F (0 to 1480°C). Type R is available in standard limits and special limits ITS-90 scale.
ASTM Type S	PT-10% Rh vs. Pt	2700°F (1480°C)	3200°F (1760°C)	Type S is composed of a positive leg (SP) which is 90% platinum and 10% rhodium, and a negative leg (SN) which is 100% platinum. When protected by compacted mineral insulation and appropriate outer sheath, Type S is usable from 32 to 2700°F (0 to 1480°C). Type S has a lower EMF output than Type R and is available in standard limits and special limits ITS-90 scale.

# Thermocouples

## High Temperature

### Exotic Metal Sheath

### Plug or Jack Termination

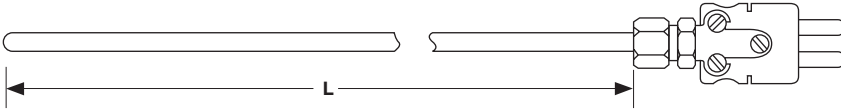

- High temperature insulations
- Loose pack assemblies
- Plug or jack cold end terminations

## Ordering Information

### Part Number

① ②	③	④	⑤	⑥	⑦	⑧ ⑨	⑩	⑪	⑫	⑬ ⑭	⑮
HC	Sheath O.D.	Connector Type	0	Insulation	Sheath Material	Sheath Length "L" (in.)	Sheath Length "L" (fract. in.)	Junction	Calibration	00	Special Rqmts.

③ Sheath O.D. (in.)	
G =	0.125
H* =	0.188
J* =	0.250
* Not available with molybdenum sheath, see chart on page 74.	

④ Connector Type	
A =	Standard plug
B =	Standard jack
C =	Standard plug with mating connector
<b>Note:</b> Standard plugs and jacks 400°F (205°C), 0.250 in. max. O.D.	

⑥ Insulation	
B =	Loose pack Al <sub>2</sub> O <sub>3</sub>
D =	Loose pack HfO <sub>2</sub>

⑦ Sheath Material	
3 =	Molybdenum
Q =	Alloy 600

⑧ ⑨ Sheath Length "L" (in.)	
Whole inches: 01 to 60	

⑩ Sheath Length "L" (fractional in.)	
0 =	0
4 =	1/2

⑪ Junction	
U =	Ungrounded - Single
Contact Factory	Ungrounded - Dual

⑫ Calibration	
B =	ASTM Type B - Standard limits
R =	ASTM Type R - Standard limits
S =	ASTM Type S - Standard limits
<b>Note:</b> For special limits contact the factory.	

⑮ Special Requirements	
0 =	None
<b>Note:</b> If required, contact the factory.	

# Thermocouples

## High Temperature

### Exotic Metal Sheath

### Metal Transitions

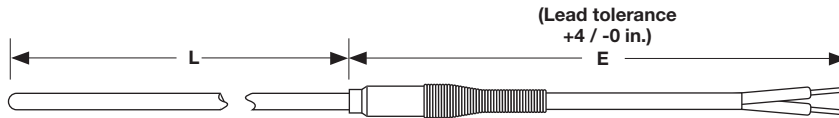

- High temperature insulations
- Loose pack assemblies
- Transition with lead wire termination
- Standard maximum continuous operating temperature of 500°F (260°C) for the transition.

## Ordering Information

### Part Number

① ②	③	④	⑤	⑥	⑦	⑧ ⑨	⑩	⑪	⑫	⑬ ⑭	⑮
	Sheath O.D.	Lead Wire Const.	Lead Wire Term.	Insulation	Sheath Material	Sheath Length "L" (in.)	Sheath Length "L" (fract. in.)	Junction	Calibration	Lead Wire Length "E" (ft)	Special Rqmts.
HF											

③ Sheath O.D.	
G =	0.125
H* =	0.188
J* =	0.250
* Not available with molybdenum sheath.	

④ Lead Wire Construction	
A =	Fiberglass solid - standard
J =	Fiberglass solid - overbraid

⑤ Lead Wire Termination	
A =	Standard plug
B =	Standard jack
C =	Standard plug with mating connector
F =	Miniature plug
G =	Miniature jack
H =	Miniature plug with mating connector
T =	Standard - 1 1/2 in. split leads
U =	1 1/2 in. split leads with space lugs
W =	1 1/2 in. split leads with BX connector and spade lugs

⑥ Insulation	
B =	Loose pack Al <sub>2</sub> O <sub>3</sub>
D =	Loose pack HfO <sub>2</sub>

⑦ Sheath Material	
3 =	Molybdenum
Q =	Alloy 600

⑧ ⑨ Sheath Length "L" (in.)	
Whole inches: 01 to 60	

⑩ Sheath Length "L" (fractional in.)	
0 =	0
4 =	1/2

⑪ Junction	
U =	Ungrounded - Single
Contact Factory	Ungrounded - Dual

⑫ Calibration	
B =	ASTM Type B - Standard limits
R =	ASTM Type R - Standard limits
S =	ASTM Type S - Standard limits
<b>Note:</b> For special limits contact the factory.	

⑬ ⑭ Lead Wire Length "E" (ft)	
Whole feet: 01 to 25 (01 foot standard)	

⑮ Special Requirements	
M =	Standard 500°F (260°C) potting

# Thermocouples

## MICROCOIL™

### Accurate, Repeatable, Fast Response in Perpendicular Surface Measurement

Watlow's MICROCOIL™ miniature thermocouple provides surface temperature measurements that deliver an unparalleled degree of accuracy. This patented technology achieves critical isothermal surface temperature measurement and offers superior design flexibility.

Typical sensor-to-sensor repeatability of one to two percent (DT) can be achieved with the MICROCOIL because sensor areas that are vulnerable to normal production variances are not inside of the thermal gradient. Weld location, insulation thickness and welded tip thickness no longer impact measurement in an isothermal environment. Therefore, the inherent challenges of measuring surface temperatures no longer exist.

The MICROCOIL thermocouple utilizes Watlow's XACTPAK® mineral insulated thermocouple cable. When used with an ungrounded junction, the sensor is electrically isolated from the surface being measured. For higher voltage applications, the aluminum nitride sensor disc option can be used for additional protection. The helix design of the MICROCOIL thermocouple elicits a faster response time because the surface temperature conducts only through the diameter of the cable and the width of the sensor disk.

Thermal analysis demonstrates the superior performance of the MICROCOIL technology. This patented process achieves critical isothermal area for a long length of a very small cable, ensuring accurate and repeatable measurement.

Standard straight sensors experience poor accuracy of response time, non-repeatable results as well as errors ranging from 20 to 30 percent and higher.

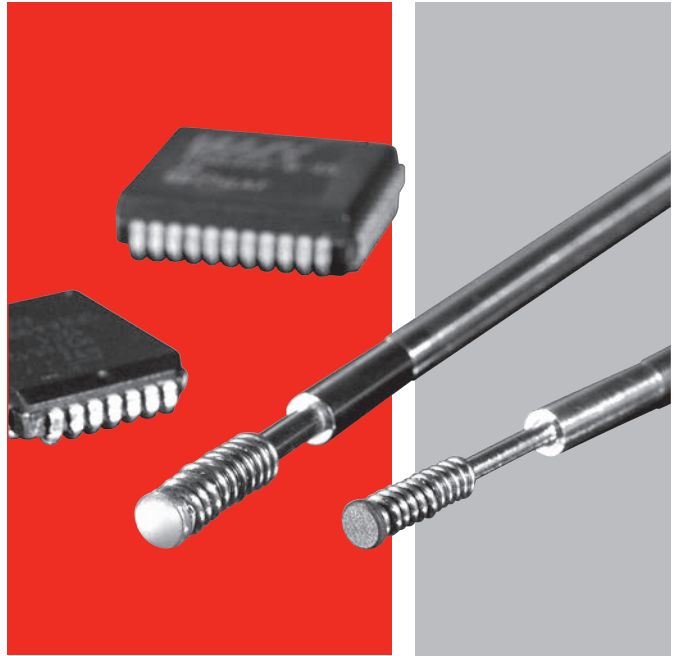

### Features and Benefits

#### Miniature size

- Allows for precision measurement in tight spaces

#### XACTPAK mineral insulated thermocouple cable

- Electronically isolated and shielded 1292°F (700°C) maximum continuous temperature
- Offers exact measurement for demanding applications

#### Self leveling and loading

- Provides superior repeatability of measurement for a wide variety of surfaces

#### Typical Applications

- Environmental chambers
- Chip cases
- Heat sinks
- Packaging
- Platens



# Thermocouples

## MICROCOIL

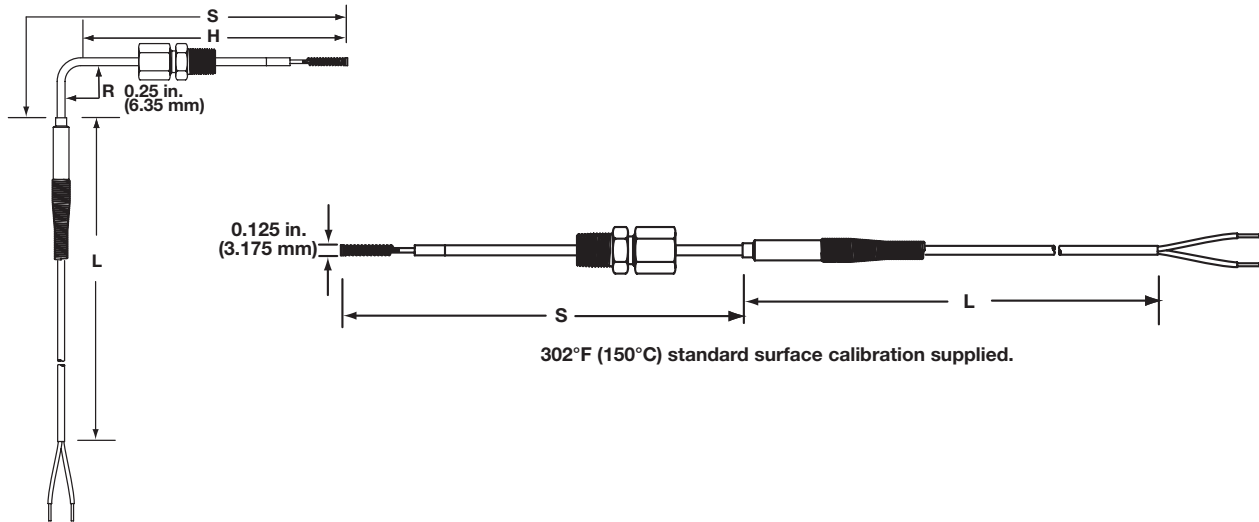

### Ordering Information

#### Part Number

① ②	③	④	⑤ ⑥	⑦	⑧	⑨	⑩ ⑪	⑫
MC	Temp. Rating	Junction Type	Sheath Length "S"	Hot Leg Length "H"	Fitting, Optional	Lead Length Const.	Lead Length "L"	Lead Wire Term.

**Type K Calibration.** 0.020 inch diameter Alloy 718 thermocouple sheath, 0.125 inch coil diameter, 12.5 oz approx. spring force for 0.0500 inch compression.

③ Temperature Rating	
C =	Copper tip 662°F (350°C) max.
N =	Aluminum nitride 1292°F (700°C) max.

④ Junction Type	
G =	Grounded single junction
U =	Ungrounded single junction

⑤ ⑥ Sheath Length "S"	
XX =	02 to 18 in.

⑦ Hot Leg Length "H", if 90° bend (in.)	
0 =	N/A, straight length
A =	1.125
D =	1.500
H =	2.000
M =	2.500
S =	3.000

**Notes:** Bend radius is 0.25 in.  
 Cold leg length (1 inch min.) = S - H - 0.4 inch  
 If a fitting is ordered, it will be installed hand tightened onto the hot leg.  
 If a fitting is ordered, the min. hot leg length "H" is 2.500 in.

⑧ Fitting, Optional	
0 =	None
C =	Compression fitting, adjustable, 1/8 in. NPT, TFE gland

⑨ Lead Length Construction, Solid Conductors	
1 =	24 gauge fiberglass
2 =	26 gauge FEP with shield and drain not attached
5 =	24 gauge FEP with stainless steel overbraid

⑩ ⑪ Lead Length "L"	
XX =	03 to 99 in.

⑫ Lead Wire Terminations	
A =	Standard male plug
B =	Standard female jack
C =	Standard plug with mating connector
F =	Miniature male plug
G =	Miniature female jack
H =	Miniature plug with mating connector
T =	Standard, 1.5 in. split leads
U =	1.5 in. split leads with spade lugs

# Thermocouples

## Radio Frequency

Watlow's TR thermocouple probe is designed for use in plasma generation applications to ensure accurate temperature readings through radio or conduction environments where traditional sensors are ineffective. Radio frequency energy can cause serious temperature measurement errors when exposed to these types of environments.

The TR probe is constructed using a unique combination of high performance materials. The sensor tip is made from high thermal conductivity materials to provide a quick response time. High dielectric insulation electrically insulates the sensor from capacitive coupling. Lead wires are twisted to improve common mode rejection and reduce induced EMI (electromagnetic interference).

### Features and Benefits

#### 3000VDC dielectric rating

- Allows thermocouple to be used in platens with dc bias

#### High thermal conductivity design

- Ensures accurate, repeatable measurements

#### High CMMR lead wire design

- Reduces induced error from EMI

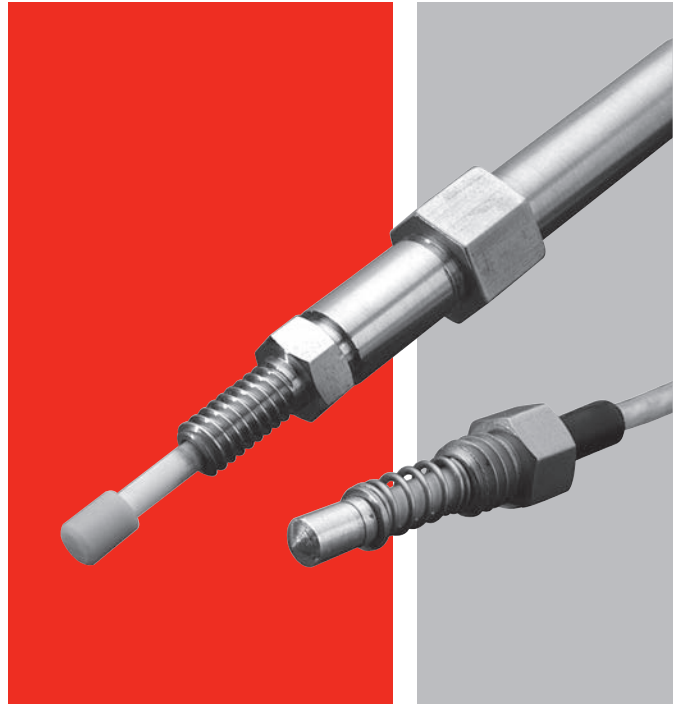

### Options

- Type K calibration
- 0.875 in. (22.23 mm) to 1.5 in. (3 mm) immersion depths
- $\frac{5}{16}$  - 18 or M8 threaded fitting
- 500°F (260°C) or 932°F (500°C) rated constructions

# Thermocouples

## Radio Frequency

### TR Thermocouple

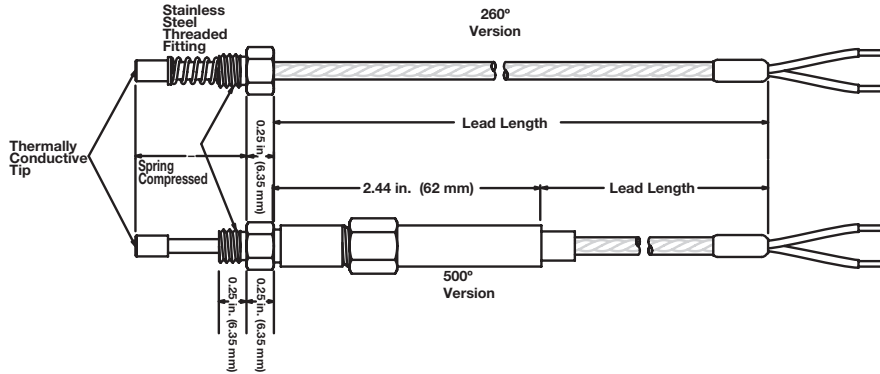

#### Platen Modification Detail

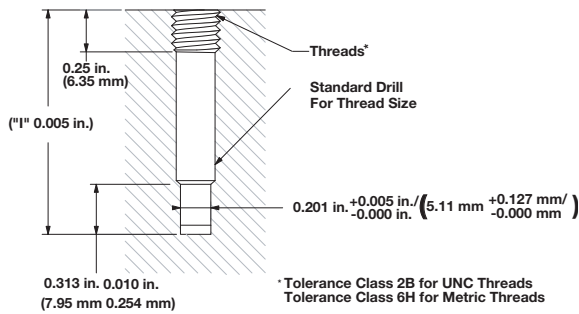

#### Tip Shape

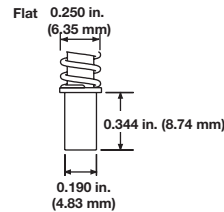

## Ordering Information

### Part Number

1	2	3	4	5	6	7	8	9	10	11	12
TR		Max. Temp.	Tip Shape	Imm. Depth "I"	Threaded Fitting Size	Junction Type	Calibration	Lead Length "L"	Lead Wire Term.		

3	Maximum Temperature
C =	260°C silver-plated copper tip
N =	500°C aluminum nitride tip (AlN)

4	Tip Shape
F =	Flat

5	6	Immersion Depth "I" (in.)
From Tip to top of threads, spring compressed		
08 =		0.875
10 =		1.000
11 =		1.125
12 =		1.250
13 =		1.375
15 =		1.500

7	Threaded Fitting Size
5 =	5/16-18 UNC-2A
8 =	M8 x 1.25-6g

8	Junction Type
U =	Ungrounded single

9	Calibration
K =	Special limits K ( $\pm 1.1^\circ\text{C}$ or $\pm 0.4\%$ )

10	11	Lead Length "L"
XX =		12 to 48 in.

12	Lead Wire Terminations
A =	Standard male plug
B =	Standard female jack
C =	Standard plug with mating connector
F =	Miniature male plug
G =	Miniature female jack
H =	Miniature plug with mating connector
T =	Standard, 1.5 in. split leads
U =	1.5 in. split leads with spade lugs

# Thermocouples

## TRUE SURFACE (TST)

### Increase Surface Temperature Accuracy with Improved Thermocouple Design

Watlow's TRUE SURFACE thermocouple (TST) offers superior accuracy for measuring flat surface temperatures. This compact, highly accurate sensor isolates the thermocouple junction from ambient airflow. The TST typically achieves accuracy and repeatability between one to two percent ( $\Delta T$ ).

The TST, with its removable molded cover, fits into corners and other tight locations. TSTs are easy to install with a variety of commonly used screw types.

Watlow's TST sensor is ideal for many applications including semiconductor chambers, platens, packaging, cleaning and food preparation.

### Features and Benefits

#### Isothermal measuring junction

- Offers excellent thermal conductivity for the measuring junction

#### Molded insulator

- Isolates the isothermal measuring block from ambient airflow

#### Compact, universal package

- Fits into corners and other tight locations easily (0.44 in. (11.88 mm) side by 0.24 in. (6.10 mm) high)
- Molded insulator is removable for applications where an even smaller package is needed

#### Temperature rating of 400°F (200°C)

- Offers superior application flexibility for a wide variety of surfaces

### Options

- Ungrounded or grounded junction(s)
- Type J or K calibrations
- Shielded lead wire with drain, either isolated from or connected to the sensor sheath

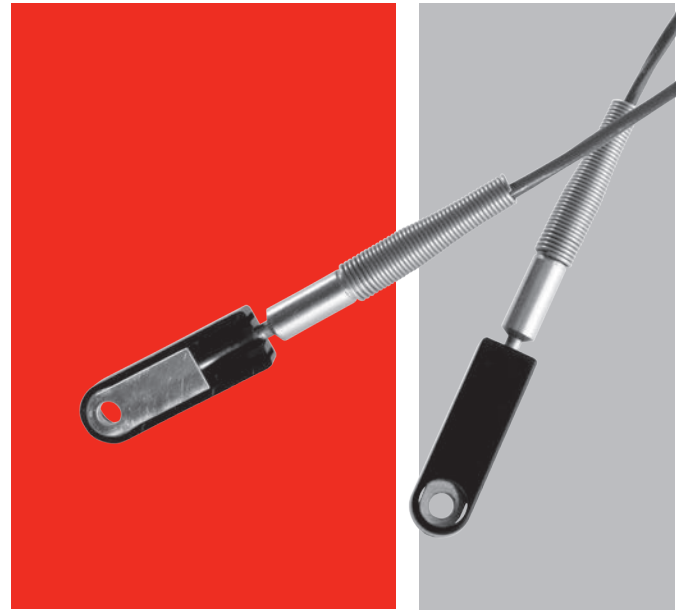

### Steady State Temperature Measurement Test

- **Purpose:** To determine and compare the steady state error of the Watlow TST and a common "washer"-style thermocouple at several temperature settings with and without ambient airflow.
- **Test Description:** Each sensor was attached to a brass hot plate and allowed to reach equilibrium before temperature readings were taken. Room temperature air was then blown onto the hot plate and the sensors. Temperature readings were taken after the system reached the new equilibrium point. The test was performed with a 20, 40, 60 and 80°C differential between the hot plate temperature and ambient.
- **Results:** Ambient temperature = 25°C.

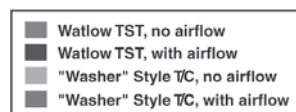
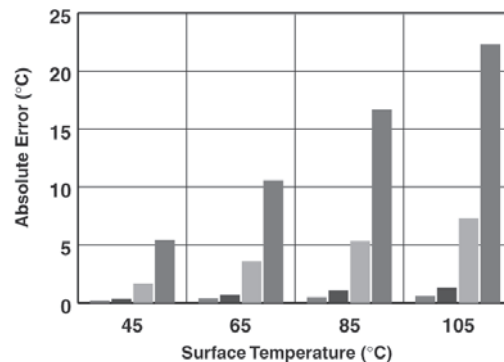

# Thermocouples

## TRUE SURFACE (TST)

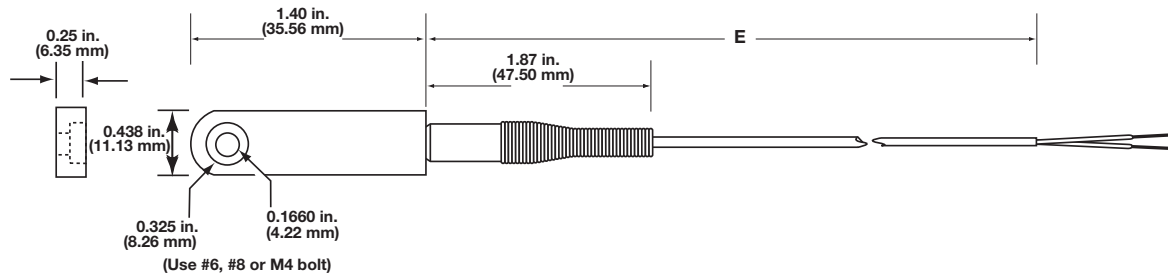

### Ordering Information

#### Part Number

1 2 3	4	5	6	7	8 9
	Lead Wire Const.	Lead Wire Term.	Junction Type	Calibration	Lead Length "E"
TST					

4 Lead Wire Construction	
2 =	FEP 26 gauge solid
3 =	FEP 26 gauge solid with shield and ground, not continuous to sheath (Terminations A, B and C are not available with this lead wire construction).

5 Lead Wire Terminations	
A =	Standard male plug
B =	Standard female jack
C =	Standard plug with mating connector
F =	Miniature male plug
G =	Miniature female jack
H =	Miniature plug with mating connector
T =	Standard, 1.5 in. split leads
U =	1.5 in. split leads with spade lugs

6 Junction Type		
	Grounded	Ungrounded
Single	G	U

7 Calibration		
	J	K
Standard limits	J	K
Special limits	3	4

8 9 Lead Length "E"	
01 to 99 feet	

# Thermocouples

## Multipoints

Temperature variances exist in all systems, regardless of materials, working fluid or system design. There is not a process that involves heating a particular medium where temperature of that medium is consistent throughout—temperature gradients always exist. Sensing temperature at a single location during a process is acceptable for many applications because temperature gradients are often insignificant. However, there is a need for many applications to monitor temperature in multiple locations to ensure a safe, accurate and cost efficient process. Installing multiple, independent temperature sensors may be impractical due to cost or space limitations.

Multipoint temperature sensors accurately measure temperatures at various locations along the sensor's length. They are used across a broad range of processes and installations—predominately in applications involving a large or complex process where close temperature control is necessary.

Multipoint temperature sensors are designed to meet requirements of specific applications that include temperature, pressure, chemical environments, time response and number of points required. Sensors are constructed from a variety of protecting tube materials that use XACTPAK mineral insulated, metal-sheathed cable. Multipoint temperature sensors are available in standard or special ASTM thermocouple calibration tolerances. For applications requiring extreme accuracy, special constructions can be made with platinum resistance temperature detectors (RTDs).



### Typical Applications

- Chemical processing
- Petroleum distillation towers
- Semiconductor manufacturing
- Profiles of furnaces and kilns
- Combustion research
- Storage tanks
- Air flow ducts

# Thermocouples

## Multipoints

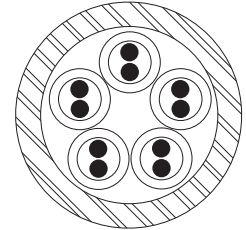
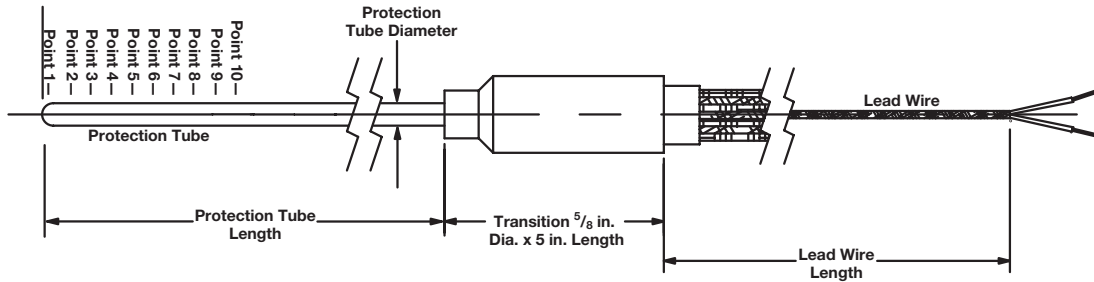

Thermocouple sensors made from mineral insulated, metal-sheathed cable are positioned inside the overall protection sheath.

**Note:** Sensor point locations are measured from the protection tube tip. Please specify point location when ordering.

## Ordering Information

### Part Number

① ②	③	④ ⑤	⑥	⑦	⑧	⑨ ⑩ ⑪	⑫	⑬ ⑭	⑮
AW	Prot. Tube Dia.	Number of Points	Prot. Tube Materials	Calibration	Junction	Protection Tube Length	Lead Wire Const.	Lead Wire Length	Lead Wire Term.

③ Protection Tube Diameter (in.)	
G =	0.125
H =	0.188
J =	0.250

④ ⑤ Number of Points	
	01, 02, 03, 04, 05, 06, 07, 08, 09, 10

⑥ Protection Tube Materials	
F =	316 SS
Q =	Alloy 600

⑦ Calibration		
	<b>J</b>	<b>K</b>
Standard limits	J	K
Special limits	3	4

⑧ Junction	
G =	Grounded
U =	Ungrounded

⑨ ⑩ ⑪ Protection Tube Length (in.)	
	006 to 096

⑫ Lead Wire Construction	
A =	Fiberglass solid wire
C =	FEP solid wire

⑬ ⑭ Lead Wire Length (ft)	
	01 to 25

⑮ Lead Wire Terminations	
A =	Standard male plug
B =	Standard female jack
C =	Standard plug with mating connector
F =	Miniature male plug
G =	Miniature female jack
H =	Miniature plug with mating connector
T =	Standard, 1½ in. split leads





# Resistance Temperature Sensors

Product	Description	Temperature		Accuracy	Page
		°F	°C		
<b>RTDs</b>	Accurate, repeatable and interchangeable over a wide operating range.	-328 to 1200	-200 to 650	DIN Class A ± 0.06% at 32°F (0°C) DIN Class B ±0.12% at 32°F (0°C)	<b>88</b>
<b>Thermistors</b>	Highly sensitive to small changes in temperature, fairly accurate over a limited temperature range.	-75 to 500	-60 to 260	±1% at 77°F (25°C) to ±15% at 32°F (0°C)	<b>99</b>
<b>ENVIROSEAL™ HD</b>	Suited for heavy-duty applications including those in harsh environments.	-40 to 392	-40 to 200	Available with either RTD or thermistors. See information above.	<b>106</b>

Resistance Temperature Sensors



# Resistance Temperature Sensors



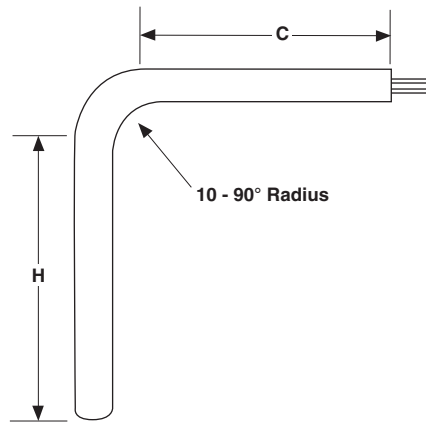

## RTDs

### Bends

Diameter in.	Standard Bend Radius in.	Minimum "H" Dimension in.	Minimum "C" Dimension in.
0.125	3/8	2	2
0.188	3/8	2	2
0.250	1/2	2	2

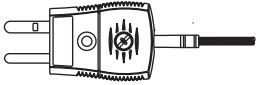
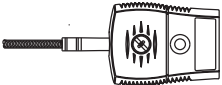
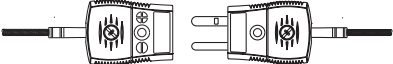

### Lead Terminations

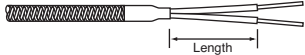
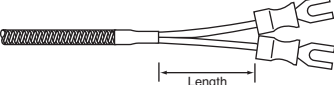
Termination	Code	Length
 Standard Male Plug	A	—
 Standard Female Jack	B	—
 Standard Male Plug with Mating Connector	C	—
 Miniature Male Plug	J	—
 Miniature Female Jack	K	—
 Miniature Male Plug with Mating Connector	L	—
 Split Leads	T	1 1/2*
 #8 Spade Lugs	U	1 1/2*

\* When style contains jacketed wire.

# Resistance Temperature Sensors



## RTDs

### Fitting Options

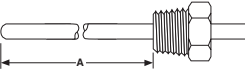
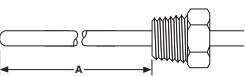
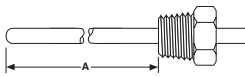
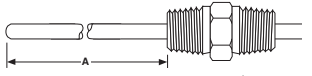
#### Fixed Fittings

Fitting Type	Material	Sheath Size in.	NPT Thread Size in.	Hex Size in.	Length in.	Code
 <p><b>Fixed Single Thread 1/8 NPT</b> Customer Specified</p>	303 SS	0.063 to 0.250	1/8	7/16	1 1/16	A
 <p><b>Fixed Single Thread 1/4 NPT</b> Customer Specified</p>	303 SS	0.125 to 0.250	1/4	9/16	7/8	B
 <p><b>Fixed Single Thread 1/2 NPT</b> Customer Specified</p>	303 SS	0.125 to 0.250	1/2	7/8	1	D
 <p><b>Fixed Double Thread 1/2 NPT</b> Customer Specified</p>	303 SS	0.125 to 0.250	1/2	7/8	1 3/4	F

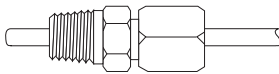
#### Compression Fittings

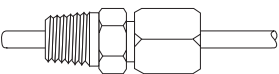
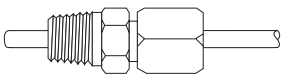
Fitting Type	Material	Sheath Size in.	NPT Thread Size in.	Hex Size in.	Length in.	Code
 <p><b>Non-Adjustable Compression Brass</b></p>	Brass	0.125	1/8	1/2	1	J
		0.188	1/8	1/2	1 1/8	J
		0.250	1/8	1/2	1 3/16	J
 <p><b>Non-Adjustable Compression SS</b></p>	303 SS	0.063	1/8	1/2	1 1/4	L
		0.125	1/8	1/2	1 1/4	L
		0.188	1/8	1/2	1 5/16	L
		0.250	1/8	1/2	1 5/16	L
 <p><b>Adjustable Compression TFE Gland</b></p>	303 SS	0.063	1/8	1/2	1 1/4	G
		0.125	1/8	1/2	1 1/4	G
		0.188	1/8	1/2	1 1/4	G
		0.250	1/4	7/8	2 7/16	X
 <p><b>Adjustable Compression Lava Gland</b></p>	303 SS	0.063	1/8	1/2	1 1/4	Q
		0.125	1/8	1/2	1 1/4	Q
		0.188	1/8	1/2	1 1/4	Q
		0.250	1/4	7/8	2 7/16	V

**Compression Fittings:** Compression fittings are shipped finger-tight on the sheath allowing field installation. Once non-adjustable fittings are deformed, they cannot be relocated. Adjustable fittings come with Tetrafluorethylene (TFE) sealant or lava sealant glands.

# Resistance Temperature Sensors

## RTDs

### Fitting Options (Continued)

#### Adjustable Spring Loaded

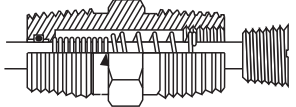
Fitting Type	Material	Sheath Size in.	NPT Thread Size in.	Hex Size in.	Length in.	Code
	316 SS	0.250	1/2	7/8	2	H

#### Bayonet Lockcap and Spring

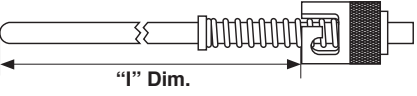
Fitting Type	Material	Sheath Size in.	Length in.	Code
	Plated Steel	0.125	1 <sup>5</sup> / <sub>8</sub>	W
	Plated Steel	0.188	1 <sup>5</sup> / <sub>8</sub>	W

# Resistance Temperature Sensors

## RTDs

Watlow manufactures a variety of RTD sensors that are specially designed to ensure precise and repeatable temperature measurement. Watlow sensors are built to meet the most demanding industrial applications while providing a lower total cost of ownership for our customers.

### Performance Capabilities

- Precise and stable within the wide temperature range of -328 to 1200°F (-200 to 650°C)

### Features and Benefits

#### Strain-free construction

- Provides dependable, accurate readings
- Allows elements from different lots to be substituted with no recalibration needed

#### High signal-to-noise output

- Increases accuracy of data transmission
- Permits greater distances between sensor and measuring equipment

#### Temperature coefficient (alpha) carefully controlled while insulation resistance values exceed DIN-IEC-751 standards

- Ensures sensor sensitivity
- Minimizes self heating
- Allows precise measurement
- Repeatable

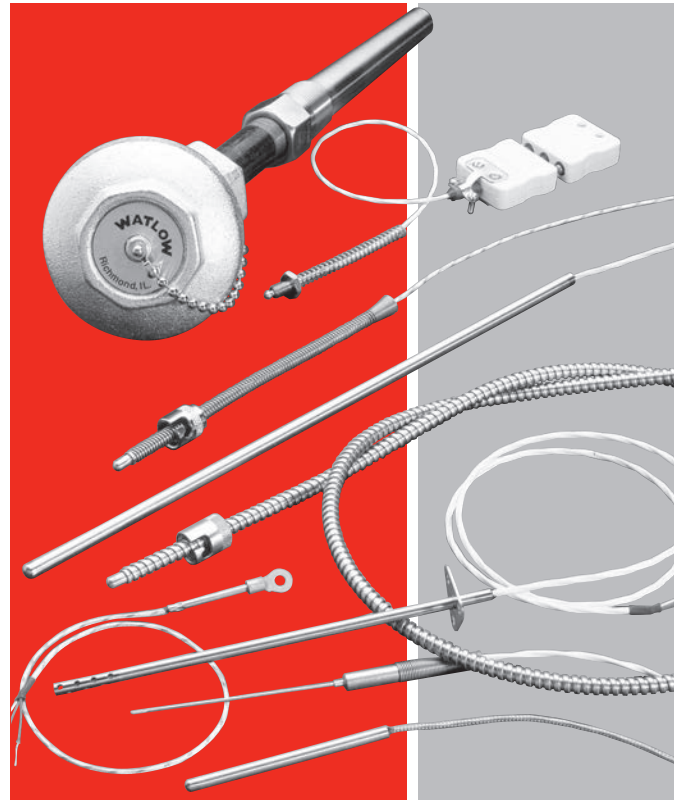

### Typical Applications

- Stoves, grills, fryers and other food equipment
- Textile production
- Plastics processing
- Petrochemical processing
- Air, gas and liquid temperature measurement
- Exhaust gas temperature measurement
- Semiconductor processing
- Bearing and gear boxes

# Resistance Temperature Sensors

## RTDs

### Standard Industrial Insulated Leads Style RB

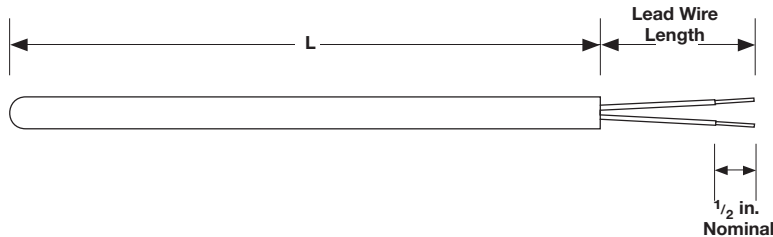

## Ordering Information

### Part Number

①	②	③	④	⑤	⑥	⑦	⑧	⑨	⑩	⑪	⑫	⑬	⑭	⑮
RB		Sheath O.D. (in.)	Lead Wire Const.	Fittings	Lead Wire Term.	Sheath Const.	Sheath Length "L" (in.)	Sheath Length "L" (fract. in.)	Element	Initial Element Accuracy	Lead Wire Length (ft)			0

③ Sheath O.D. (in.)	
G =	0.125
H =	0.188
J =	0.250
<b>Note:</b> 0.125 dia. supplied with 28 gauge wire. 0.188 and 0.250 dia. supplied with 24 gauge wire.	

④ Lead Wire Construction*			
	Standard	Overbraid	Flex Armor
Fiberglass stranded	A	J*	R*
PFA stranded	B	L*	T*
Certain option combinations must be furnished with a transition between the sheath and lead wire. Contact the factory if a transition is unacceptable.			
*May require a transition.			

⑤ Fittings	
If required, enter the order code from pages 89 to 90. If none enter "0".	

⑥ Lead Wire Termination	
A* =	Standard male plug 400°F (200°C)
B* =	Standard female jack
C* =	Standard plug with mating connector
J* =	Male miniature plug
K* =	Female miniature jack
L* =	Male/female mini set
T =	Standard leads
U =	Leads with spade lugs
* Requires two-or three-wire, single element only.	

⑦ Sheath Construction	
A =	316/316L SS

⑧ ⑨ Sheath Length "L" (in.)	
Available lengths: 02 to 36	

⑩ Sheath Length "L" (fractional in.)	
0 =	No fraction, whole inches
4 =	1/2 in.

⑪ Element			
	2-Wire	3-Wire	4-Wire
100Ω single	A	B	C
100Ω dual*	D	E	—
1000Ω single	J	K	L
* Available in 0.250 inch diameter only.			

⑫ Initial Element Accuracy @ 0°C	
A =	DIN Class A (±0.06%)
B =	DIN Class B (±0.12%)

⑬ ⑭ Lead Wire Length (ft)	
Whole feet: 01 to 99	
<b>Note:</b> Single wires for 4 feet and under. Duplex wires for over 4 feet.	

**Note:** Applies to low temperature RTD's only.

## Features and Benefits

### High accuracy

- Dependable readings

### Customized diameters

- From 0.125 to 0.250 inch

### Epoxy sealed

- Resists moisture and pull out
- Standard 500°F (260°C) potting

### Durable rigid sheath

- 316 stainless steel -58 to 500°F (-50 to 260°C)

### Internal heat transfer paste

- Quick time response

# Resistance Temperature Sensors

## RTDs

### Plug or Jack Termination Style RC

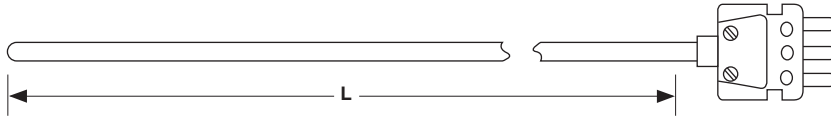

## Ordering Information

### Part Number

① ②	③	④	⑤	⑥	⑦	⑧ ⑨	⑩	⑪	⑫	⑬ ⑭	⑮		
RC		Sheath O.D. (in.)	Cold End Term.	Fittings	0	Sheath Const.	A	Sheath Length "L" (in.)	Sheath Length "L" (fract. in.)	Element	Initial Element Accuracy	00	0

③ Sheath O.D. (in.)	
G =	0.125
H =	0.188
J =	0.250
<b>Note:</b> 0.125 dia. supplied with 28 gauge wire. 0.188 and 0.250 dia. supplied with 24 gauge wire.	

④ Cold End Termination	
A =	Standard plug
C =	Standard plug with mating connector
<b>Note:</b> Standard plugs and jacks 400°F (200°C).	

⑤ Fittings	
If required, enter the order code from pages 89 to 90. If none enter "0".	

⑦ Sheath Construction	
A =	316/316L SS

⑧ ⑨ Sheath Length "L" (in.)	
Whole inches: 02 to 36	

⑩ Sheath Length "L" (fractional in.)	
0 =	No fraction, whole inches
4 =	1/2 in.

⑪ Element		
	2-Wire	3-Wire
100Ω single	A	B
1000Ω single	J	K

⑫ Initial Element Accuracy @ 0°C	
A =	DIN Class A (±0.06%)
B =	DIN Class B (±0.12%)

## Features and Benefits

### Durable rigid sheath

- 316 SS -58 to 500°F (-50 to 260°C)

### Durable connectors with copper pins

- 400°F (200°C) temperature rating
- Provides simple connection to extension leads

### Brazed adapter

- Provides superior connector attachment

### High accuracy

- Ensures dependable readings

# Resistance Temperature Sensors

## RTDs

### Metal Transitions Style RF

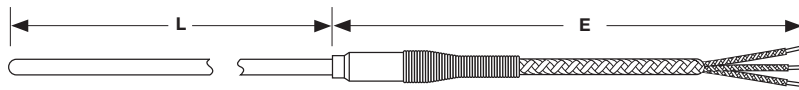

## Ordering Information

### Part Number

1 2	3	4	5	6	7	8 9	10	11	12	13 14	15
RF	Sheath O.D. (in.)	Lead Wire Const.	Fittings	Lead Wire Term.	Sheath Const.	Sheath Length "L" (in.)	Sheath Length "L" (fract. in.)	Element	Initial Element Accuracy	Lead Wire Length (ft)	
RF											0

3	Sheath O.D. (in.)
G =	0.125
H =	0.188
J =	0.250
<b>Note:</b> All sheath diameters, MI cable only (high temp) are 24 gauge duplex lead wire.	

4	Lead Wire Construction		
	Standard	Overbraid	Flex Armor
Fiberglass stranded	A	J	R
PFA stranded	B	L	T

5	Fittings
If required, enter the order code from pages 89 to 90. If none enter "0".	

6	Lead Wire Termination
A*	Standard male plug
B*	Standard female jack
C*	Standard plug with mating connector
J*	Male miniature plug
K*	Female miniature jack
L*	Male/female mini set
T	Standard leads
U	Leads with spade lugs
* Requires two- or three-wire, single element only.	

7	Sheath Construction
K =	316/316L SS mineral insulated

8 9	Sheath Length "L" (in.)
Whole inches: 03 to 99, metric lengths and lengths over 99 inches contact factory. Maximum length 165 inches.	

10	Sheath Length "L" (fractional in.)
0 =	No fraction, whole inches
4 =	1/2 in.

11	Element	
	2-Wire	3-Wire
100Ω single	A	B

12	Initial Element Accuracy @ 0°C	
A =	DIN Class A (±0.06%)	
B =	DIN Class B (±0.12%)	

13 14	Lead Wire Length (ft)
Whole feet: 01 to 99	

## Features and Benefits

### Stainless steel transitions filled with 500°F (260°C) epoxy

- Protects sensor from moisture
- Encapsulates connection between wire and cable

### Coiled spring strain relief

- Protects lead wire against sharp bends in the transition area

### Flexible mineral insulated construction

- Provides a bendable and highly durable sensor

### Temperature rating

- -328 to 1200°F (-200 to 650°C)

### High accuracy

- Ensures dependable readings

### Diameters available

- 0.125 to 0.250 inch O.D.



# Resistance Temperature Sensors

## RTDs

### Connection Head/Optional Transmitter Style RR



## Ordering Information

### Part Number

1	2	3	4	5	6	7	8	9	10	11	12	13	14	15
RR		Sheath O.D. (in.)	Con. Head	Head Mtg. Fittings		Sheath Const.	Sheath Length "L" (in.)	Sheath Length "L" (fract. in.)	Element	Initial Element Accuracy			Tag Style	
RR					0							00		

3 Sheath O.D. (in.)	
G =	0.125
H =	0.188
J =	0.250
<b>Note:</b> 0.125 dia. supplied with 28 gauge wire. 0.188 and 0.250 dia. supplied with 24 gauge wire.	

4 Connection Head	
C =	Polypropylene
D =	Cast iron
E =	Cast aluminum
H =	Explosion proof
U* =	E head with 5750 transmitter
V* =	C head with 5750 transmitter
W* =	H head with 5750 transmitter
* For units with transmitter, the order must specify a range and degree F or C, as well as a temperature span.	

5 Head Mounting Fittings	
O =	Single threaded, 303 SS
F =	Double threaded, 303 SS 1/2 in. NPT
H* =	Spring loaded, double threaded, 316 SS 1/2 in. NPT
* Available in 0.250 inch diameter only.	

7 Sheath Construction		
	-58 to 500°F (-50 to 260°C) 316 SS	-328 to 1200°F (-200 to 650°C) 316 SS
Standard industrial (0.125 - 0.250 in. O.D.)	A	—
Mineral insulated (0.125 - 0.250 in. O.D.)	—	K

8 9 Sheath Length "L" (in.)	
A =	Sheath construction requires 2 in. min to 36 in. max. length
K =	Sheath construction requires 3 in. min to 99 in. max. length

10 Sheath Length "L" (fractional in.)	
0 =	No fraction, whole inches
1 =	1/8
2 =	1/4
3 =	3/8
4 =	1/2
5 =	5/8
6 =	3/4
7 =	7/8

11 Element			
	2-Wire	3-Wire	4-Wire
100Ω single	A	B	C
100Ω dual *, **	D	E	—
1000Ω single **	J	K	L
* Available in 0.250 inch diameter only. ** Available with standard industrial construction only.			

12 Initial Element Accuracy @ 0°C	
A =	DIN Class A (±0.06%)
B =	DIN Class B (±0.12%)

15 Tag Style	
0 =	Polymeric
1 =	300 SERIES SST

## Features and Benefits

### Connection heads

- Provides superior dust and moisture resistance

### Weatherproof plastic heads

- Resists weak acids, organic solvents, alkalis, sunlight and dust

### Complete assembly available

- Head-mounted 4-20mA transmitter, three- or four-wire input and non-isolated

# Resistance Temperature Sensors

## RTDs

### For Use With Thermowells Style RT

Type 1

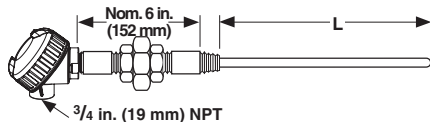

6 inch N-U-N Typical (2 each 1/2 X 3 inch steel pipe nipples and 1 each malleable union)

Type 3

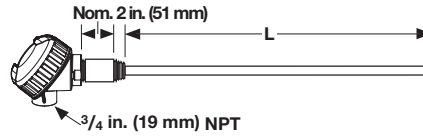

1/2 x 3 inch long steel pipe nipple typical

Type 4

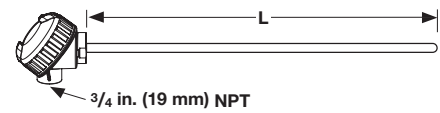

## Ordering Information

### Part Number

1	2	3	4	5	6	7	8	9	10	11	12	13	14	15
RT	Sheath O.D. (in.)	Conn. Head	Cold End Config.		Sheath Const.	Sheath Length "L" (in.)	Sheath Length "L" (fract. in.)	Element	Initial Element Accuracy		Spring-Loading	Tag Style		
RT				0							0			

3 Sheath O.D. (in.)	
J =	0.250
<b>Note:</b> Supplied with 24 gauge wire.	

4 Connection Head	
C =	Polypropylene
D =	Cast iron
E =	Cast aluminum
H =	Explosion proof
U* =	E head with 5750 transmitter
V* =	C head with 5750 transmitter
W* =	H head with 5750 transmitter
* For units with transmitter, the order must specify a range and degree F or C, as well as a temperature span.	

5 Cold End Configuration	
1 =	Type 1
3 =	Type 3
4 =	Type 4

7 Sheath Construction		
	-58 to 500°F (-50 to 260°C) 316 SS	-328 to 1200°F (-200 to 650°C) 316 SS
Standard industrial (0.125 - 0.250 in. O.D.) (Max. length 36 in.)	A	—
Mineral insulated (0.125 - 0.250 in. O.D.) (Max. length 165 in.)	—	K

8 9 Sheath Length "L" (in.) - See Drawings Above	
*When ordering a complete assembly with thermowell, specify "AR" as required and reference pages 115 to 120 for "U" dimension; otherwise, specify the "L" dimension in whole inches.	
<b>*Note,</b> maximum sheath length is 36 inches for sheath construction A.	

10 Sheath Length "L" (fractional in.)	
0 =	No fraction, whole inches
1 =	1/8
2 =	1/4
3 =	3/8
4 =	1/2
5 =	5/8
6 =	3/4
7 =	7/8

11 Element			
	2-Wire	3-Wire	4-Wire
100Ω single	A	B	C
100Ω dual*	D	E	—
1000Ω single*	J	K	L
* Available with standard industrial construction only.			

12 Initial Element Accuracy @ 0°C	
A =	DIN Class A (±0.06%)
B =	DIN Class B (±0.12%)

14 Spring -Loading	
Y =	Yes
N =	No

15 Tag Style	
0 =	Polymeric
1 =	300 SERIES SST

## Features and Benefits

### High quality thermowells and pipe wells

- Protects sensor

### Mineral insulated construction

- Available in 0.125 to 0.250 inch O.D.

### Available with spring-loading

- Ensures positive contact

### Complete assembly available

- Head-mounted 4-20mA transmitter, three- or four-wire input and non-isolated

### Variety of connection head options

- Meets your application requirements

# Resistance Temperature Sensors

## RTDs

### Specialty Construction Styles

#### Adjustable Spring Style

Part Number 10 = 6 in.  
Part Number 11 = 12 in.

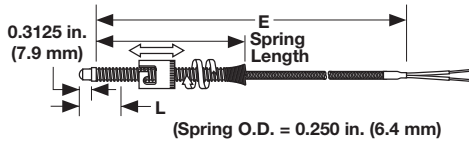

#### Open Air

Part Number 50

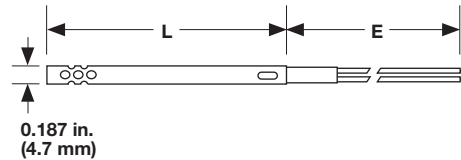

#### Adjustable Armor Style

Part Number 12

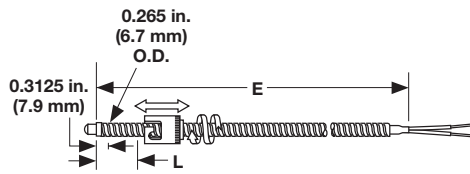

#### Open Air with Flange

Part Number 55

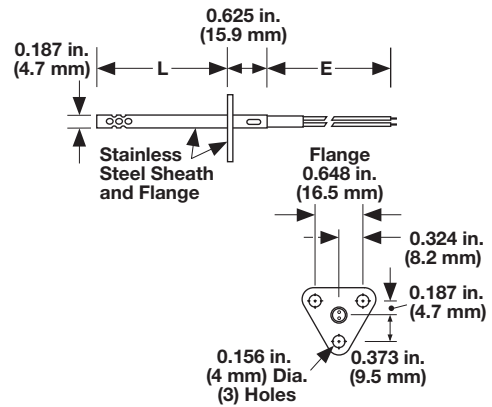

#### Cartridge with Flange

Part Number 25

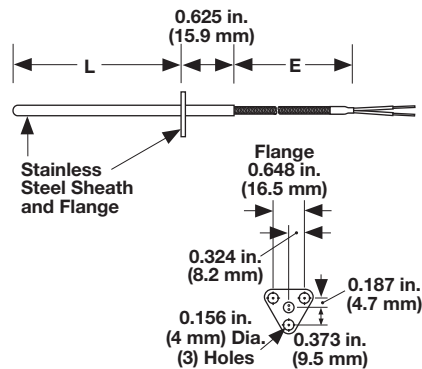

#### Surface Mount

Part Number 80

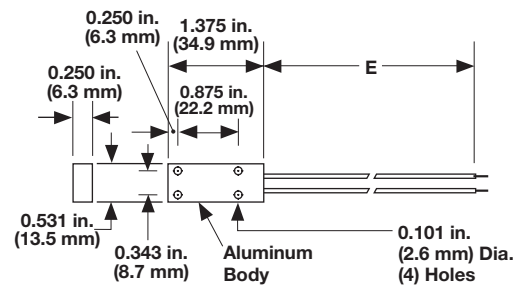

# Resistance Temperature Sensors

## RTDs

### Specialty RTDs

### Ordering Information

#### Part Number

①	② ③	④	⑤	⑥ ⑦	⑧	⑨ ⑩ ⑪	⑫
	Const. Styles	Diameter (in.)	Element Type	Lead Type	Sheath Length "L" (in.)	Lead Wire Length "E" (ft)	Term.
S							

② ③	Construction Styles
10 =	6 inch adjustable spring style
11 =	12 inch adjustable spring style
12 =	Adjustable armor style
25 =	Cartridge with flange
50 =	Open air
55 =	Open air with flange
80 =	Surface mount
<b>Note:</b> See previous page for construction style drawings.	

④	Diameter (in.)
D =	0.188
A =	Not applicable: surface mount

⑤	Element Type
C =	RTD 2-wire, 100Ω DIN 0.00385
D =	RTD 3-wire, 100Ω DIN 0.00385

⑥ ⑦	Lead Type
L4 =	Fiberglass and SS armor
M4 =	Fiberglass
N4 =	Fiberglass and SS overbraid
T2 =	PFA

⑧	Sheath Length "L" (in.)		
A =	Not applicable	K = 5.0 in.	T = 9.0 in.
C* =	1.5 in.	L = 5.5 in.	U = 9.5 in.
D =	2.0 in.	M = 6.0 in.	W = 10 in.
E =	2.5 in.	N = 6.5 in.	Y = 11 in.
F =	3.0 in.	P = 7.0 in.	Z = 12 in.
G =	3.5 in.	Q = 7.5 in.	
H =	4.0 in.	R = 8.0 in.	
J =	4.5 in.	S = 8.5 in.	
* 1.5 required for VAT construction: No. 10, 11, 12)			

⑨ ⑩ ⑪	Lead Wire Length "E" (ft)	
012 =	1 ft	084 = 7 ft
024 =	2 ft	096 = 8 ft
036 =	3 ft	108 = 9 ft
048 =	4 ft	120 = 10 ft
060 =	5 ft	180 = 15 ft
072 =	6 ft	

⑫	Terminations
A =	1.5 inch stripped split leads, no terminals
B =	No. 8 spade terminals
H =	0.25 in. female quick connect terminals

### Specifications

- Two- or three-wire
- Resistance: 100Ω at 0°C
- Alpha curve: 0.00385Ω/Ω/°C
- Tolerance at 0°C: ±0.12%
- Range: -58 to 500°F (-50 to 260°C)

# Resistance Temperature Sensors

## Thermistors

Watlow thermistors are designed to ensure fast, accurate and repeatable temperature measurement. Thermistors are highly sensitive to small changes in temperature and maintain accurate temperatures over a limited range. These sensors are made with either epoxy-coated or glass-coated constructions and can be used in the most demanding environmental conditions.

### Performance Capabilities

- Epoxy thermistors are suitable for use from -75 to 302°F (-60 to 150°C). Glass-coated thermistors are available for use from -75 to 500°F (-60 to 260°C). Please contact the factory for availability. Thermistors have an accuracy of  $\pm 1\%$  at 77°F (25°C).

### Features and Benefits

#### Designed to maintain accuracy over the life of the sensor

- Improved process control

#### High resistance

- Large signal change compared to RTDs minimizing the impact of lead wire resistance errors

#### Interchangeable

- Maintains good system repeatability

#### Small mass and internal heat transfer paste

- Quick time response

#### Point sensitive

- Able to sense temperature in a very specific location

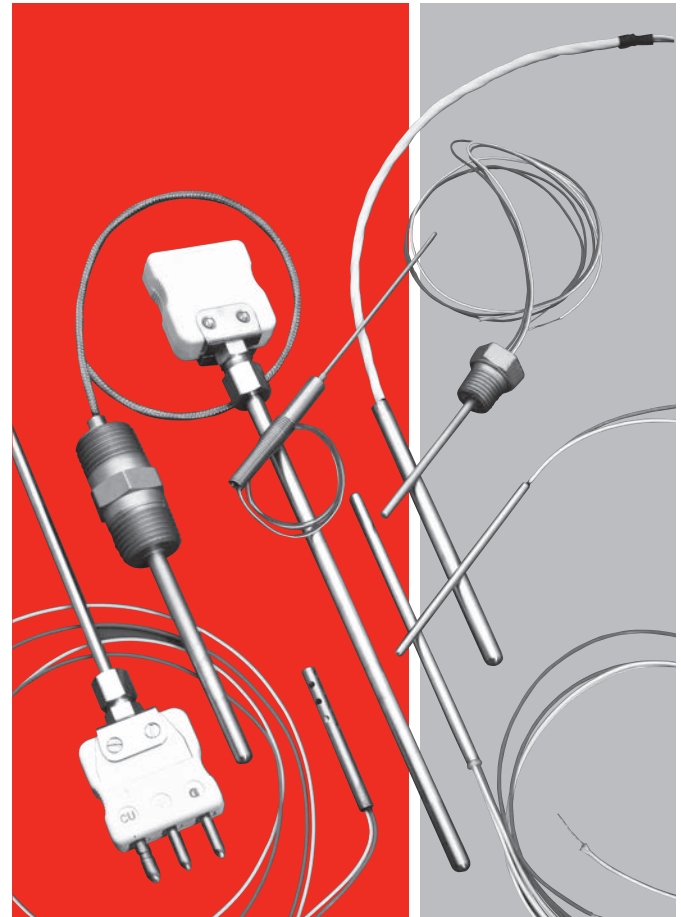

### Typical Applications

#### Heating, ventilation and air conditioning (HVAC)

- Air conditioning
- Refrigeration and freezer temperature control

#### Food preparation

- Deep fryers
- Food storage systems

#### Medical

- Blood analysis and dialysis equipment
- Infant incubators

#### Industrial electronics

- Fluid temperature measurement
- Liquid level indicators

# Resistance Temperature Sensors



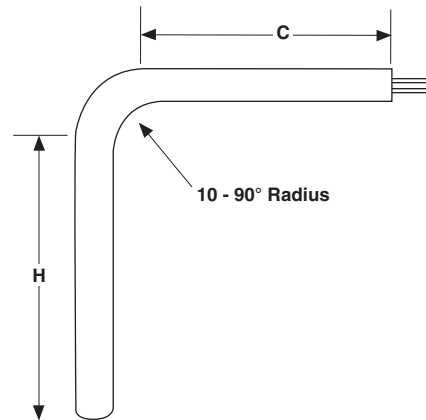

## Thermistors

### Bends

Diameter in.	Standard Bend Radius in.	Minimum "H" Dimension in.	Minimum "C" Dimension in.
0.125	3/8	2	2
0.188	3/8	2	2
0.250	1/2	2	2

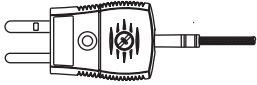
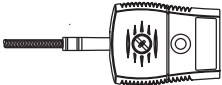
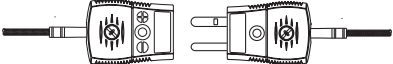

### Lead Terminations

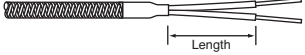
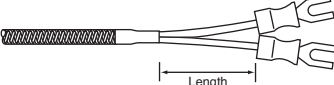
Termination	Code	Length
 Standard Male Plug	A	—
 Standard Female Jack	B	—
 Standard Male Plug with Mating Connector	C	—
 Miniature Male Plug	J	—
 Miniature Female Jack	K	—
 Miniature Male Plug with Mating Connector	K	—
 Split Leads	T	1 1/2*
 #8 Spade Lugs	U	1 1/2*

\* When style contains jacketed wire.

# Resistance Temperature Sensors

## Thermistors

### Fitting Options

#### Fixed Fittings

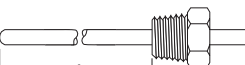
Fitting Type	Material	Sheath Size in.	NPT Thread Size in.	Hex Size in.	Length in.	Code
 <p><b>Fixed Single Thread 1/8 NPT</b> Customer Specified</p>	303 SS	0.063 to 0.250	1/8	7/16	1 1/16	A
 <p><b>Fixed Single Thread 1/4 NPT</b> Customer Specified</p>	303 SS	0.125 to 0.250	1/4	9/16	7/8	B
 <p><b>Fixed Single Thread 1/2 NPT</b> Customer Specified</p>	303 SS	0.125 to 0.250	1/2	7/8	1	D
 <p><b>Fixed Double Thread 1/2 NPT</b> Customer Specified</p>	303 SS	0.125 to 0.250	1/2	7/8	1 3/4	F

#### Compression Fittings

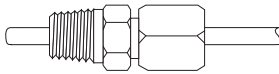
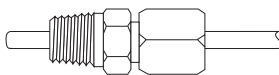
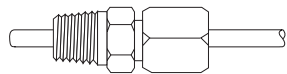
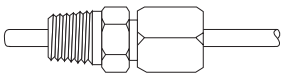
Fitting Type	Material	Sheath Size in.	NPT Thread Size in.	Hex Size in.	Length in.	Code
 <p><b>Non-Adjustable Compression Brass</b></p>	Brass	0.125	1/8	1/2	1	J
		0.188	1/8	1/2	1 1/8	J
		0.250	1/8	1/2	1 3/16	J
 <p><b>Non-Adjustable Compression SS</b></p>	303 SS	0.063	1/8	1/2	1 1/4	L
		0.125	1/8	1/2	1 1/4	L
		0.188	1/8	1/2	1 5/16	L
		0.250	1/8	1/2	1 5/16	L
 <p><b>Adjustable Compression TFE Gland</b></p>	303 SS	0.063	1/8	1/2	1 1/4	G
		0.125	1/8	1/2	1 1/4	G
		0.188	1/8	1/2	1 1/4	G
		0.250	1/4	7/8	2 7/16	X
 <p><b>Adjustable Compression Lava Gland</b></p>	303 SS	0.063	1/8	1/2	1 1/4	Q
		0.125	1/8	1/2	1 1/4	Q
		0.188	1/8	1/2	1 1/4	Q
		0.250	1/4	7/8	2 7/16	V

**Compression Fittings:** Compression fittings are shipped finger-tight on the sheath allowing field installation. Once non-adjustable fittings are deformed, they cannot be relocated. Adjustable fittings come with TFE or lava sealant glands.

# Resistance Temperature Sensors

## Thermistors

### Fitting Options (Continued)

#### Adjustable Spring Loaded

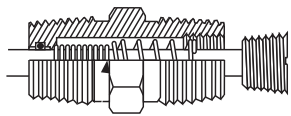
Fitting Type	Material	Sheath Size in.	NPT Thread Size in.	Hex Size in.	Length in.	Code
	316 SS	0.250	1/2	7/8	2	H

#### Bayonet Lockcap and Spring

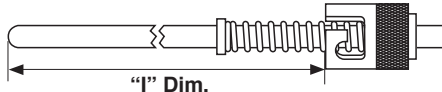
Fitting Type	Material	Sheath Size in.	Length in.	Code
	Plated Steel	0.125	1 <sup>5</sup> / <sub>8</sub>	W
	Plated Steel	0.188	1 <sup>5</sup> / <sub>8</sub>	W



# Resistance Temperature Sensors

## Thermistors

### Standard Industrial Thermistor with Insulated Leads Style TB

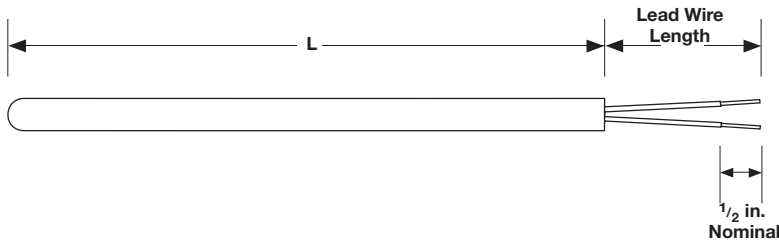

## Ordering Information

### Part Number

①	②	③ Sheath O.D. (in.)	④ Lead Wire Const.	⑤ Fittings	⑥ Lead Wire Term.	⑦ Temp. Rating & Accuracy	⑧ ⑨ Sheath Length "L" (in.)	⑩ Sheath Length "L" (fract. in.)	⑪ Element/ Resistance	⑫ Sheath	⑬ ⑭ Lead Wire Length "E" (ft)	⑮
T	B		B							0		0

③ Sheath O.D. (in.)	
H =	0.188
J =	0.250

④ Lead Wire Construction	
B =	Standard - PFA

⑤ Fittings	
If required, enter order code from pages 101 to 102. If none enter "0".	

⑥ Lead Wire Termination	
T =	Standard leads
U =	Leads with spade lugs

⑦ Temperature Rating and Accuracy	
A* =	-75 to 302°F (-60 to 150°C) ±1% accuracy @ 25°C
B** =	-75 to 500°F (-60 to 260°C) ±15% accuracy @ 25°C
* Only available with 1,000, 2,200, 3,000 or 10,000Ω	
** Only available with 100,000Ω	

⑧ ⑨ Sheath Length "L" (in.)	
Whole inches: 02 to 36	

⑩ Sheath Length "L" (fractional in.)	
0 =	0
4 =	1/2 in.

⑪ Element/Resistance at 77°F (25°C)	
E =	1,000Ω
G =	3,000Ω
T =	100,000Ω
F* =	2,200Ω
* Compatible with EZ-ZONE controllers	

⑫ Sheath Construction	
0 =	316 SS

⑬ ⑭ Lead Wire Length "E" (ft)	
Whole feet: 01 to 99	

## Features and Benefits

### Rigid 316 stainless steel sheath

- Ideal for industrial applications

### Cold end epoxy seal

- Rated to 260°C (500°F)

### Internal heat transfer paste

- Quick time response

# Resistance Temperature Sensors

## Thermistors

### Specialty Construction Styles

#### Adjustable Spring Style

Part Number 10 = 6 in.  
Part Number 11 = 12 in.

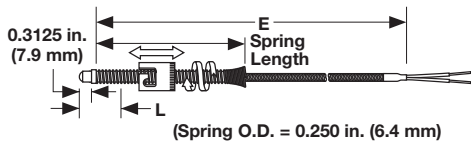

#### Adjustable Armor Style

Part Number 12

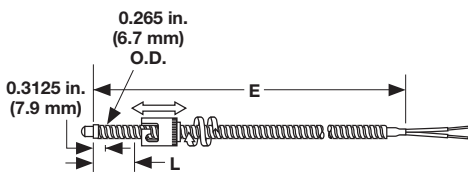

#### Cartridge with Flange

Part Number 25

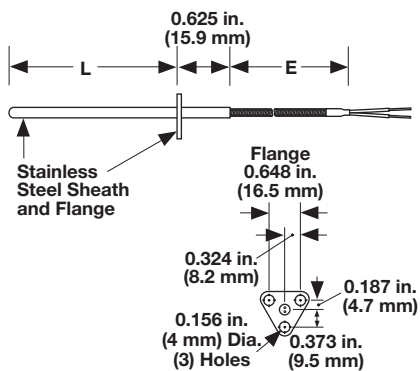

#### Open Air

Part Number 50

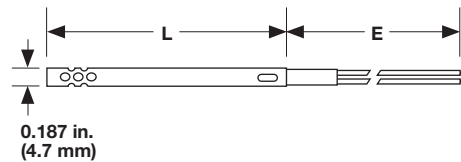

#### Open Air with Flange

Part Number 55

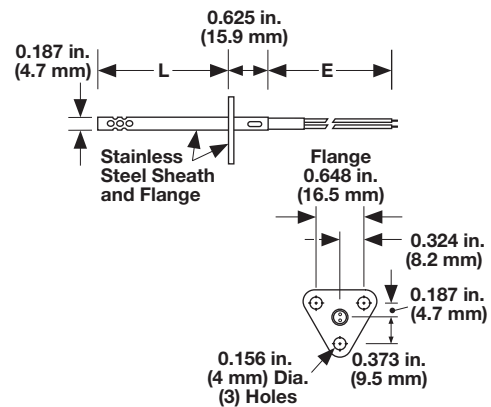

#### Surface Mount

Part Number 80

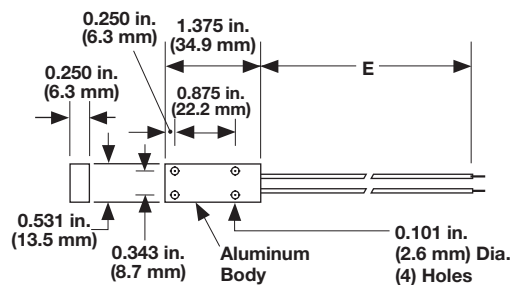

# Resistance Temperature Sensors

## Thermistors

### Specialty Thermistors

### Ordering Information

#### Part Number

1	2 3	4	5	6 7	8	9 10 11	12
S	Const. Styles	Diameter (in.)	Element Type	Lead Type	Sheath Length "L" (in.)	Lead Wire Length "E" (ft)	Term.
S							

2 3	Construction Styles
10 =	6 inch adjustable spring style
11 =	12 inch adjustable spring style
12 =	Adjustable armor style
25 =	Cartridge with flange
50 =	Open air
55 =	Open air with flange
80 =	Surface mount
<b>Note:</b> See previous page for construction style drawings.	

4	Diameter (in.)
D =	0.188
A =	Not applicable: surface mount

5	Element Type
M =	Thermistor No. 11, 1,000Ω
N =	Thermistor No. 12, 3,000Ω
P =	Thermistor No. 16, 100,000Ω
<b>Note:</b> Contact the factory for other thermistors which are available on request. See Style TB thermistor.	

6 7	Lead Type
L4 =	Fiberglass and SS armor
M4 =	Fiberglass
N4 =	Fiberglass and SS overbraid
T2 =	PFA

8	Sheath Length "L" (in.)		
A =	Not applicable	K = 5.0 in.	T = 9.0 in.
C* =	1.5 in.	L = 5.5 in.	U = 9.5 in.
D =	2.0 in.	M = 6.0 in.	W = 10 in.
E =	2.5 in.	N = 6.5 in.	Y = 11 in.
F =	3.0 in.	P = 7.0 in.	Z = 12 in.
G =	3.5 in.	Q = 7.5 in.	
H =	4.0 in.	R = 8.0 in.	
J =	4.5 in.	S = 8.5 in.	
* 1.5 required for VAT construction: No. 10, 11, 12			

9 10 11	Lead Wire Length "E" (ft)	
012 =	1 ft	084 = 7 ft
024 =	2 ft	096 = 8 ft
036 =	3 ft	108 = 9 ft
048 =	4 ft	120 = 10 ft
060 =	5 ft	180 = 15 ft
072 =	6 ft	

12	Terminations
A =	1.5 inch stripped split leads, no terminals
B =	No. 8 spade terminals
H =	0.25 in. female quick connect terminals

### Specifications

- Metal oxide, sintered and encapsulated
- Negative temperature coefficient
- Non-linear temperature/resistance curve
- Resistance at 77°F (25°C) and ranges:

Epoxy Bead Tolerance			
Configuration	Resistance	Accuracy @ 25°C	Max. Temp.
#11	1K	±1%	150°C
#12	3K	±1%	150°C

Glass Bead Tolerance			
Configuration	Resistance	Accuracy @ 25°C	Max. Temp.
#16	100K	±20%	300°C

# Resistance Temperature Sensors

EXTENDED  
CAPABILITY

## ENVIROSEAL™ HD Sensors

Watlow's ENVIROSEAL™-HD temperature sensor keeps out moisture, oil and contaminants in all heavy-duty applications including those outside applications exposed to harsh weather, oils and other extreme moisture environments. The ENVIROSEAL-HD sensor is designed to provide accurate, dependable measurements in high-vibration environments.

### Features and Benefits

#### Submersible and 1200psi pressure wash rated seal (not including connector area)

- Protects the sensor from washdown or other extreme moisture environments

#### Oil resistant materials

- Sensors maintain a long life even when exposed to oil, gasoline or diesel fuel

#### Vibration resistant design, 25 lb pull out force rating

- Tough, rugged design to hold up to the roughest applications

#### -40 to 392°F (-40 to 200°C) sensor temperature rating

- Offers superior application flexibility

#### Time response of two seconds

- Fast response measures 63.2 percent (first order) of the temperature change in two seconds or less

#### 250psi threaded fitting pressure rating

- Suitable for most rugged applications

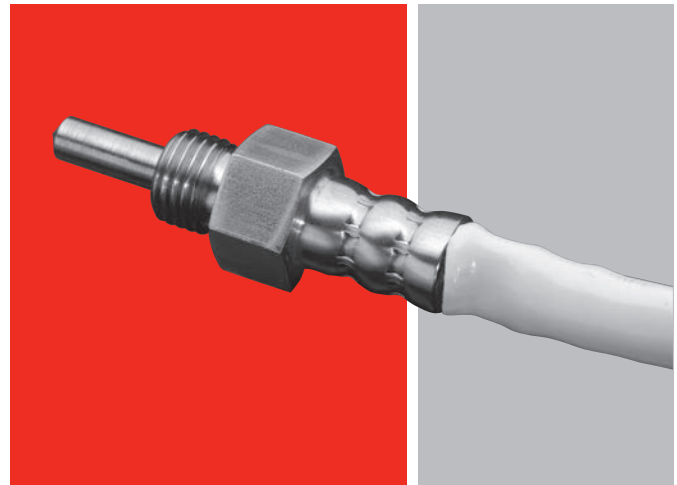

### Typical Applications

- Engine coolant or oil
- Refrigeration or condensation units
- Industrial equipment
- Heat exchangers
- Gear boxes
- Hydraulic fluid
- Marine

# Resistance Temperature Sensors

EXTENDED  
CAPABILITY

## ENVIROSEAL HD Sensors

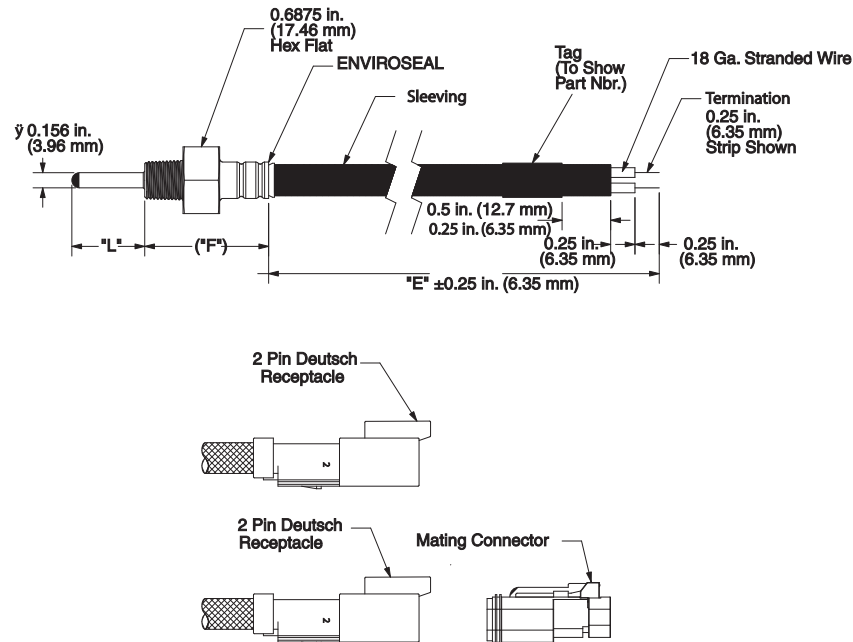

### Sensor Types:

- RTD or thermistor
- Sheath length: 0.75 to 3 inches
- Fitting: 1/4 inch NPT or 1/8 inch NPT male thread either brass or 316 stainless steel
- Lead length: up to 24 inches
- Lead wire: 18 gauge stranded with Tefzel® insulation
- Lead wire terminations: stripped leads or Deutsch 2 pin connector or similar automotive style connector



# Accessories

Product	Description	Page
<b>Fittings</b>	A variety of sensor mounting fittings are available such as fixed, adjustable, non-adjustable, compression and bayonet style.	<b>111</b>
<b>Thermowells</b>	Thermowells are manufactured from drilled bar stock and provide a pressure-tight connection at the point of installation. These thick-wall thermowells are sturdy enough to handle high pressure, high velocity and corrosive environments. Suited for applications where the sensors are not compatible with the environment.	<b>115</b>
<b>Protection Tubes</b>	Constructed of ceramic or metal. The metal protection tubes are suited for high thermal conductivity for fast, precise readings. The ceramic tubes resist deformation, corrosion, abrasion and oxidation.	<b>121</b>
<b>Connectors</b>	Many varieties of connectors are available such as standard, quick-attach, high-temperature, three-pole and miniature connectors. All Watlow connectors meet the ASTM E1129 requirement and are color coded.	<b>125</b>
<b>Connection Heads and Blocks</b>	Watlow offers standard cast iron or aluminum, explosion proof and polypropylene heads. Terminal blocks are available to complement the connection heads.	<b>132</b>
<b>Transmitters</b>	Watlow's temperature transmitters offer accurate measurement and improved reliability which reduces downtime and costs. The two-wire signal conditioner is constructed using surface mount and digital technology.	<b>134</b>







# Accessories

## Fittings

### Sensor Mounting Fittings - Non-Adjustable

#### Non-Adjustable Compression Type

Non-adjustable compression type fittings allow the exact immersion length to be set in the field during sensor installation. Since the compression sleeve and sheath are deformed in application, the fitting cannot be relocated

along the sheath after tightening. When ordered as a part of a sensor for mounting the thermocouple, all compression type fittings are shipped finger-tight on the sheath.

#### Brass Compression Fitting, Non-Adjustable

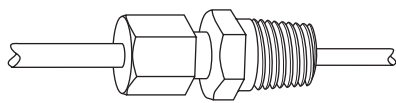

Brass Compression Fitting, Assembled



Cap



Sleeve

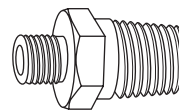

Body

Part No.	Sheath O.D. in.	Material	Bore +0.10, -0.000 in.	Male NPT in.	Length in.
TH-185-2	0.125	Brass	0.130	1/8	1
TH-185-3	0.188	Brass	0.192	1/8	1 1/8
TH-185-4	0.250	Brass	0.256	1/8	1 3/16
TH-185-5	0.250	Brass	0.256	1/4	1 3/8
TH-185-6	0.313	Brass	0.318	1/4	1 3/8
TH-185-7	0.375	Brass	0.380	1/4	1 7/16
TH-185-9	0.250	Brass	0.256	1/2	1 3/4

#### Stainless Steel Compression Fitting, Non-Adjustable

Made entirely of 303 stainless steel

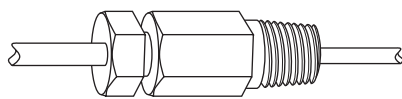

Single Threaded

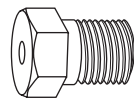

Cap



Ferrule

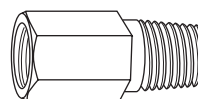

Body

Single Threaded		Sheath O.D. in.	Bore ±0.001 in.	Male NPT in.	Hex Across Flats in.
Part No.	Length (in.)				
TH-2745-063	1/4	0.063	0.067	1/8	1/2
TH-2745-125	1/4	0.125	0.129	1/8	1/2
TH-2745-188	1 1/16	0.188	0.194	1/8	1/2
TH-2745-250	1 1/16	0.250	0.257	1/8	1/2

**Note:** All accessories are subject to minimum purchase quantities.

# Accessories

## Fittings

### Sensor Mounting Fittings - Adjustable

#### Adjustable Compression Type

Adjustable compression type fittings can be relocated at different positions along the sheath whenever changes in the immersion length are necessary. To relocate an adjustable compression fitting, simply loosen the cap, slide the fitting to the new location and retighten the cap.

It is recommended that lava sealant glands be replaced after each tightening. Tetrafluorethylene (TFE) sealant glands should withstand several relocations before replacement is necessary.

#### Stainless Steel Adjustable Compression Fitting

Except for their sealant glands, these fittings are made entirely of 303 stainless steel. Sealant glands are available in lava, -300 to 1000°F (-184 to 540°C) and TFE, -300 to 500°F (-184 to 260°C). Unless otherwise specified,\* TFE sealant glands are provided. Fittings are pressure rated up to 3,000psi depending on temperature and sheath diameter.

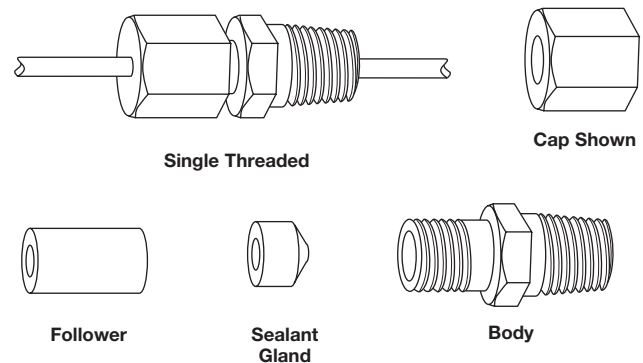

Single Threaded		Sheath O.D. in.	Bore +0.002 in.	Male NPT in.	Hex Across Flats in.	Replacement Sealant Glands, Neoprene
Part No.*	Length in.					
TH-2747-T-063	1 <sup>1</sup> / <sub>4</sub>	0.063	0.067	1/8	1/2	TH-279-T-063
TH-2747-T-125	1 <sup>1</sup> / <sub>4</sub>	0.125	0.136	1/8	1/2	TH-279-T-125
TH-2747-T-188	1 <sup>1</sup> / <sub>4</sub>	0.188	0.193	1/8	1/2	TH-279-T-188
TH-2748-T-250	2 <sup>7</sup> / <sub>16</sub>	0.250	0.257	1/4	7/8	TH-280-T-250
TH-2748-T-313	2 <sup>7</sup> / <sub>16</sub>	0.313	0.316	1/4	7/8	TH-280-T-313
TH-2748-T-375	2 <sup>7</sup> / <sub>16</sub>	0.375	0.386	1/4	7/8	TH-280-T-375

\*If lava sealant glands are desired, substitute L in place of T in the part number.

#### Adjustable Spring-Loaded Hex Fitting

The adjustable spring-loaded fitting has a stainless steel body, end cap and spring and is designed for use with 0.250 inch O.D. sheath thermocouples and RTDs. This fitting is not intended for use in pressurized applications.

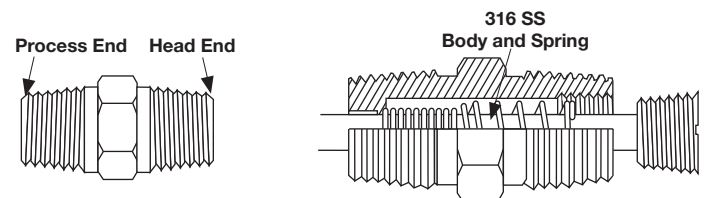

Part No.	Sheath			Male NPT in.	Hex Across Body Flats in.	Hex Across Cap Flats in.
	Length in.	O.D. in.	Material			
6556-250	2	0.250	316 SS	1/2	7/8	9/16

**Note:** All accessories are subject to minimum purchase quantities.

# Accessories

## Fittings

### Bayonet Fittings

#### Adjustable Bayonet Compression Fitting

This fitting combines features of the fixed bayonet fitting in a compact unit which does not require brazing to assemble.

The fitting is designed for 0.125 inch O.D. sensor and is available with either brass or TFE ferrules.

For TFE ferrules, the fitting may be relocated at different positions along the sheath if changes in the immersion length are necessary. Brass ferrules cannot be relocated once they are set.

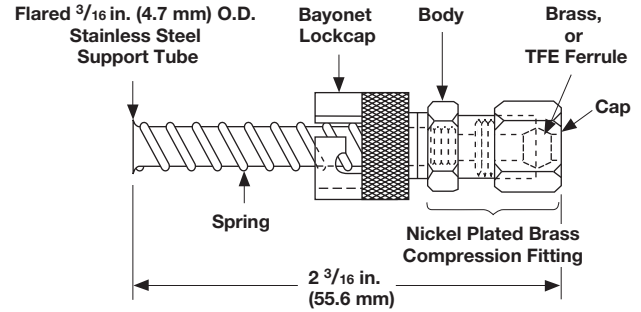

Part No.	Description
TH-2762-BR	Adjustable bayonet fitting with brass ferrule
TH-2762-T	Adjustable bayonet fitting with TFE ferrule

#### Fixed Bayonet Fitting

When used together, a bayonet fitting and bayonet adapter act as a spring-loading device for bottoming a thermocouple hot junction in a hole. The fitting is designed for use on an 0.188 inch O.D. sensor. The TH-2760 fitting includes a lockcap, spring and spring stop, which requires brazing for assembly.

The adapter requires a tapped  $1/8$  inch NPT or  $3/8$  24 hole for mounting. All components are nickel plated steel.

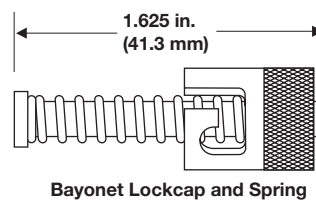

Part No.	Description
TH-2760	Lockcap, spring and spring stop

#### Bayonet Adapter

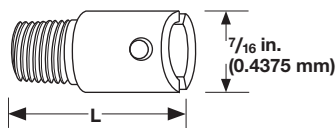

Part No.	Description	L Length in.	Thread in.
TH-295-1	Bayonet Adapter	$7/8$	$1/8$ NPT
TH-295-2		1	$1/8$ NPT
TH-295-3		$1\frac{1}{2}$	$1/8$ NPT
TH-295-4		2	$1/8$ NPT
TH-295-5		$2\frac{1}{2}$	$1/8$ NPT
TH-298-1		$7/8$	$3/8$ -24 SAE
TH-298-2		$1\frac{1}{2}$	$3/8$ -24 SAE

**Note:** All accessories are subject to minimum purchase quantities.

# Accessories

## Fittings

### Bayonet Fittings (Continued)

#### Pipe Clamp with Bayonet Adapter

The pipe clamp band with bayonet adapter is designed for use in conjunction with a bayonet style thermocouple. It allows temperature measurement without drilling or tapping. Thermocouple replacement is extremely fast and simple and is accomplished without disturbing surroundings, such as pipe insulation.

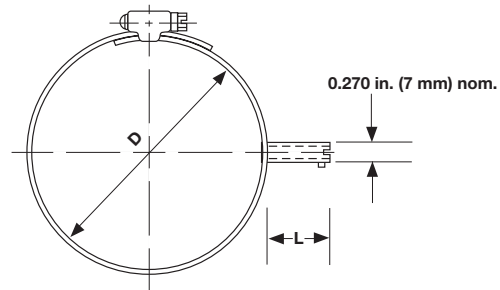

## Ordering Information

### Part Number

① ②	③	④
Const. Part	"D" Clamp Band Dia.	"L" Bayonet Adapter Length

① ②	Construction Code
90 =	Pipe clamp band with bayonet adapter

③	"D" Clamp Band Diameter Range (in.)
A =	1 <sup>1</sup> / <sub>16</sub> to 1 <sup>1</sup> / <sub>4</sub>
B =	1 <sup>1</sup> / <sub>4</sub> to 2 <sup>1</sup> / <sub>4</sub>
C =	2 <sup>1</sup> / <sub>4</sub> to 3 <sup>1</sup> / <sub>4</sub>
D =	3 <sup>1</sup> / <sub>4</sub> to 4 <sup>1</sup> / <sub>4</sub>
E =	4 <sup>1</sup> / <sub>4</sub> to 5
F =	5 to 6
G =	6 to 7

④	"L" Bayonet Adapter Length (in.)
1 =	1 (use with thermocouple that has "B" dimension = 2 in.)
2 =	2 (use with thermocouple that has "B" dimension = 3 in.)

**Note:** All combinations are available for next day shipment.

**Note:** All accessories are subject to minimum purchase quantities.

# Accessories

## Thermowells

Manufactured from drilled bar stock, Watlow thermowells provide a pressure-tight connection at the point of installation. With thick walls, thermowells are sturdy enough to handle high pressure, high velocity and corrosive environments. They are frequently used in petrochemical and power plant applications.

Highly critical or demanding applications may require thermowells not only for protection of the temperature sensor, but also to withstand high pressure, erosion or both, caused by material flows through vessels.

### Features and Benefits

#### Bar stock used to manufacture thermowells

- Provides protection against corrosion
- Round bar with wrench flats is substituted when hex is not available

### Typical Applications

- Petrochemical
- Chemical
- Oil refineries
- Power plants
- Storage tanks and lines

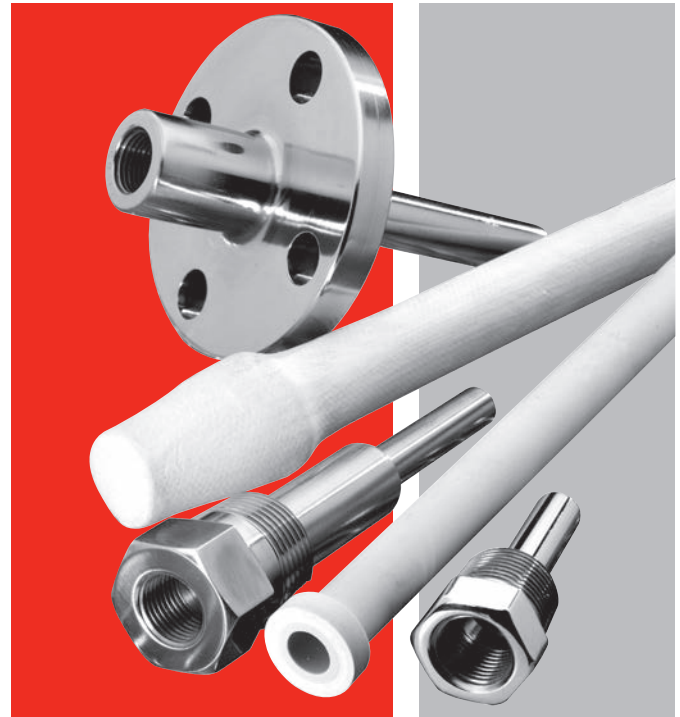

	Manufacturing Standards
Bar Stock	Mill Standards ( $\pm 0.010$ inch approximately)
Process Connection	Threaded: Inspected with standard ring gauge Flanged: Front J groove welds are $\frac{1}{4}$ inch wide by $\frac{1}{4}$ inch deep. Welds are machined, leaving $\frac{1}{8}$ inch radius. Rear welds are $\frac{1}{8}$ inch wide by $\frac{1}{8}$ inch deep. Welds are machined, leaving $\frac{1}{4}$ inch radius. Full penetration welds are available upon request. Must be specified.
Stem O.D.	Straight: $\pm 0.015$ inch Tapered: $\pm 0.015$ inch (minor dimension)
U Dimension	$\pm \frac{1}{8}$ inch
Overall Dimension	$\pm \frac{1}{8}$ inch
End Thickness	$\frac{1}{4}$ inch $\pm \frac{1}{16}$ inch
Finish	63 RMS
Bore	+0.005 inch -0.003 inch
Tapered Wells	The maximum taper on all thermowells is 16 inches +0.5 - 1.0.

Specifications listed are for standard thermowells or for thermowells manufactured where no other specifications prevail.

**Note:** All accessories are subject to minimum purchase quantities.

# Accessories

## Thermowells

### Threaded Type—Straight

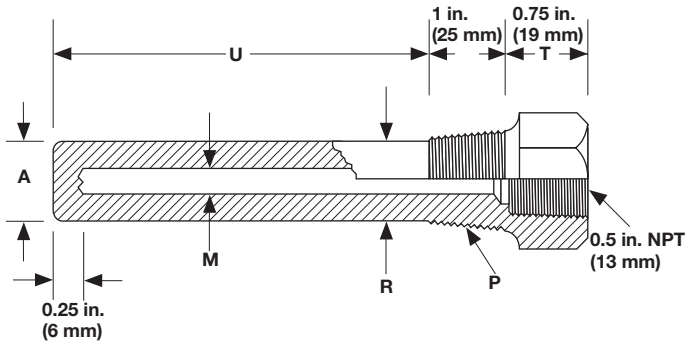

**Standard Bore Size:** 0.260 inch

**Standard Materials:** 304 SS, 316 SS

#### Typical Dimensions

Process Conn. NPT P in.	A in.	M in.	R in.	T in.
1	$\frac{49}{64}$	0.260	$\frac{49}{64}$	$\frac{3}{4}$
$\frac{3}{4}$	$\frac{49}{64}$	0.260	$\frac{49}{64}$	$\frac{3}{4}$

### Ordering Information

#### Part Number

①	②	③	④ ⑤ ⑥	⑦	⑧	⑨	⑩	⑪	⑫	⑬	⑭	⑮
T	T'Well Style	Stem Config.	"U" Dim. (fract in.)	T'Well Material	Process Conn. Size "P"	Flange Rating	Flange Face Type	Flange Material	Lag "T" (in.)	Lag "T" (fract. in.)	Bore Dia. "M"	Special Options
T	T	S							0	6		

② Thermowell Style	
T =	Threaded

③ Stem Configuration	
S =	Straight

④ ⑤ ⑥ "U" Dimension (fractional in.)	
024 =	2 <sup>1</sup> / <sub>2</sub>
044 =	4 <sup>1</sup> / <sub>2</sub>
074 =	7 <sup>1</sup> / <sub>2</sub>
104 =	10 <sup>1</sup> / <sub>2</sub>
134 =	13 <sup>1</sup> / <sub>2</sub>
164 =	16 <sup>1</sup> / <sub>2</sub>
224 =	22 <sup>1</sup> / <sub>2</sub>
<b>Note:</b> For "U" lengths not specified, contact factory.	

⑦ Thermowell Material	
A =	304
C =	316 SS

⑧ Process Connection Size "P" (in.)	
D =	$\frac{3}{4}$ NPT
E =	1 NPT

⑨ Flange Rating	
0 =	No flange

⑩ Flange Face Type	
0 =	No flange

⑪ Flange Material	
0 =	No flange

⑫ Lag "T" (in.)	
0 =	No option available

⑬ Lag "T" (fractional in.)	
6 =	$\frac{3}{4}$ - Industry Standard

⑭ Bore Diameter "M" (in.)	
A =	0.260

⑮ Special Options	
0 =	None

**Note:** All accessories are subject to minimum purchase quantities.

# Accessories

## Thermowells

### Threaded Type—Tapered

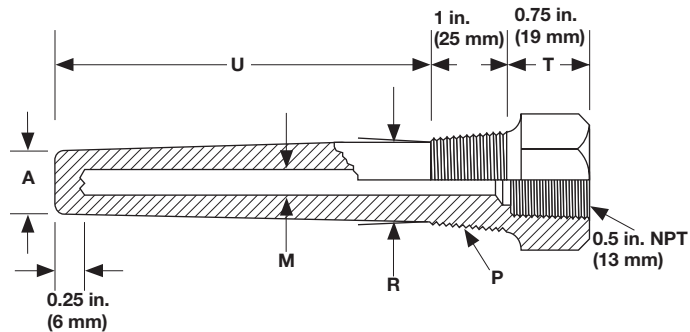

**Standard Bore Size:** 0.260 inch

**Standard Materials:** 304 SS, 316 SS

#### Typical Dimensions

Process Conn. NPT P in.	A in.	M in.	R in.	T in.
1	5/8	0.260	1 <sup>1</sup> / <sub>16</sub>	3/4
3/4	5/8	0.260	7/8	3/4

## Ordering Information

### Part Number

①	②	③	④ ⑤ ⑥	⑦	⑧	⑨	⑩	⑪	⑫	⑬	⑭	⑮
T	T'Well Style	Stem Config.	"U" Dim. (fract in.)	T'Well Material	Process Conn. Size "P"	Flange Rating	Flange Face Type	Flange Material	Lag "T" (in.)	Lag "T" (fract. in.)	Bore Dia. "M"	Special Options
T	T	T							0	6		

② Thermowell Style	
T =	Threaded

③ Stem Configuration	
T =	Standard taper

④ ⑤ ⑥ "U" Dimension (fractional in.)	
024 =	2 <sup>1</sup> / <sub>2</sub>
044 =	4 <sup>1</sup> / <sub>2</sub>
074 =	7 <sup>1</sup> / <sub>2</sub>
104 =	10 <sup>1</sup> / <sub>2</sub>
134 =	13 <sup>1</sup> / <sub>2</sub>
164 =	16 <sup>1</sup> / <sub>2</sub>
224 =	22 <sup>1</sup> / <sub>2</sub>

**Note:** For "U" lengths not specified, contact factory.

⑦ Thermowell Material	
A =	304 SS
C =	316 SS

⑧ Process Connection Size "P" (in.)	
D =	3/4 NPT
E =	1 NPT

⑨ Flange Rating	
0 =	No flange

⑩ Flange Face Type	
0 =	No flange

⑪ Flange Material	
0 =	No flange

⑫ Lag "T" (in.)	
0 =	No option available

⑬ Lag "T" (fractional in.)	
6 =	3/4 - Industry Standard

⑭ Bore Diameter "M" (in.)	
A =	0.260

⑮ Special Options	
0 =	None

**Note:** All accessories are subject to minimum purchase quantities.

# Accessories

## Thermowells

### Bimetallic Thermometer Wells—Threaded Type

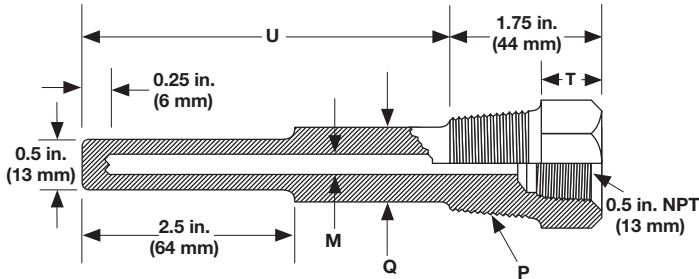

**Standard Bore Size:** 0.260 inch

**Standard Materials:** 304 SS, 316 SS

#### Typical Dimensions

Process Conn. NPT P in.	Q in.	T in.
1/2 *	5/8	1
3/4	3/4	3/4
1	7/8	3/4

\*On 1/2 inch NPT external threaded wells, the 1 inch thread allowance and 3/4 inch wrench allowance dimensions are reversed to accommodate the 1/2 inch NPT female thread.

## Ordering Information

### Part Number

①	②	③	④ ⑤	⑥	⑦	⑧	⑨	⑩	⑪	⑫	⑬	⑭	⑮
T	B	D	"U" Dim. (in.)	"U" Dim. (fract. in.)	Thermo- well Mat'l	Process Conn. "P" (in.)	Flange Rating	Flange Face Type	Flange Material	Lag "T" (in.)	Lag "T" (fract. in.)	Bore Dia "M" (in.)	Special Options

④ ⑤	"U" Dimension (in.)
Whole inches: 00 to 22	

⑥	"U" Dimension (fractional in.)
0 = 0	
4 = 1/2	

⑦	Thermowell Material
A = 304 SS	
C = 316 SS	

⑧	Process Connection "P" (in.)
C = 1/2 NPT	
D = 3/4 NPT	
E = 1 NPT	

⑨	Flange Rating
0 = No flange	

⑩	Flange Face Type
0 = No flange	

⑪	Flange Material
0 = No flange	

⑫	Lag "T" (in.)
0 = Whole inches: 0 to 9	

⑬	Lag "T" (fractional in.)
0 = 0	
1 = 1/8	
2 = 1/4	
3 = 3/8	
4 = 1/2	
5 = 5/8	
6 = 3/4	
7 = 7/8	

⑭	Bore Diameter "M" (in.)
A = 0.260	

⑮	Special Options
0 = Standard options	



# Accessories

## Thermowells

### Socket Weld Type

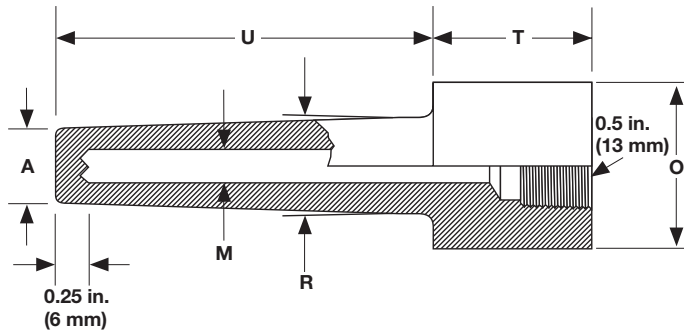

**Standard Bore Size:** 0.260 inch

**Standard Materials:** 304 SS, 316 SS

#### Typical Dimensions

Stock Size/Hex Size O in.	A in.	R in.	T in.
1.315	$\frac{49}{64}$	1	$1\frac{3}{4}$
1.050	$\frac{49}{64}$	$\frac{7}{8}$	$1\frac{3}{4}$

### Ordering Information

#### Part Number

①	②	③	④ ⑤	⑥	⑦	⑧	⑨	⑩	⑪	⑫	⑬	⑭	⑮
	Thermo- well Style	Stem Config.	"U" Dim. (in.)	"U" Dim. (fract. in.)	Thermo- well Mat'l	Process Conn. "O" (in.)	Flange Rating	Flange Face Type	Flange Material	Lag "T" (in.)	Lag "T" (fract. in.)	Bore Dia "M" (in.)	Special Options
T	S	T											

②	Thermowell Style
S =	Socket weld

③	Stem Configuration
T =	Standard taper

④ ⑤	"U" Dimension (in.)
	Whole inches: 00 to 22

⑥	"U" Dimension (fractional in.)
0 =	0
4 =	$\frac{1}{2}$

⑦	Thermowell Material
A =	304 SS
C =	316 SS

⑧	Process Connection "O" (in.)
L =	1.050 O.D.
M =	1.315 O.D.

⑨	Flange Rating
0 =	No flange

⑩	Flange Face Type
0 =	No flange

⑪	Flange Material
0 =	No flange

⑫	Lag "T" (in.)
0 =	Whole inches: 0 to 9

⑬	Lag "T" (fractional in.)
0 =	0
1 =	$\frac{1}{8}$
2 =	$\frac{1}{4}$
3 =	$\frac{3}{8}$
4 =	$\frac{1}{2}$
5 =	$\frac{5}{8}$
6 =	$\frac{3}{4}$
7 =	$\frac{7}{8}$

⑭	Bore Diameter "M" (in.)
A =	0.260

⑮	Special Options
0 =	Standard options

# Accessories

## Thermowells

### Pipe Type

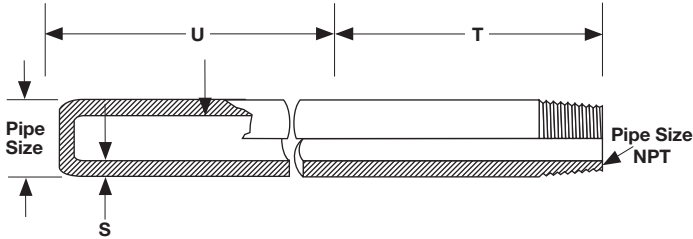

**Standard Materials:** 304, 316 and 446 SS and Alloy 601

**Note:** When no bushing is required, “U” becomes the overall length.

**Standard “T” Dimension:** 3 inches

### Ordering Information

#### Part Number

①	②	③	④ ⑤	⑥	⑦	⑧	⑨	⑩	⑪	⑫	⑬	⑭	⑮
P	Pipe Size (in.)	Pipe Type “S”	“U” Dim. (in.)	“U” Dim. (fract. in.)	Pipe Material	Process Conn. Size “P” (in.)	Flange Rating (lbs)	Flange Face Type	Bushing Alloy	Lag “T” (in.)	Lag “T” (fract. in.)	Bore Dia “M” (in.)	Special Options
		N					0	0					

② Pipe Size (in.)	
C =	1/2
D =	3/4
E =	1

③ Pipe Type “S”	
N =	Schedule 40

④ ⑤ “U” Dimension (in.)	
Whole inches: 00 to 99	

⑥ “U” Dimension (fractional in.)	
0 =	0
1 =	1/8
2 =	1/4
3 =	3/8
4 =	1/2
5 =	5/8
6 =	3/4
7 =	7/8

⑦ Pipe Material	
A =	304 SS
C =	316 SS
K =	446 SS
W =	Alloy 601

⑧ Process Connection Size “P” (in.)	
D* =	3/4 NPT
E* =	1 NPT
F* =	1 1/4 NPT
0 =	No bushing
*Includes mounting bushing	

⑨ Flange Rating (lbs)	
0 =	No flange

⑩ Flange Face Type	
0 =	No flange

⑪ Bushing Alloy	
0 =	No bushing
A =	304 SS
C =	316 SS
G =	Carbon steel
K =	446 SS
W =	Alloy 601

⑫ Lag “T” (in.)	
Whole inches: 0 to 9	

⑬ Lag “T” (fractional in.)	
0 =	0
1 =	1/8
2 =	1/4
3 =	3/8
4 =	1/2
5 =	5/8
6 =	3/4
7 =	7/8

⑭ Bore Diameter “M” (in.)	
J =	Per pipe size

⑮ Special Options	
0 =	None
X =	Special requirements, contact factory

**Note:** All accessories are subject to minimum purchase quantities.

## Protection Tubes

Both ceramic and metal (pipe type) protecting tubes protect the temperature sensor from harsh environments. Unlike thermowells, they are not primarily designed for pressure tight applications. Protection tubes are often used in heat treatment furnaces, ovens, open container, flues and ducts.

Protecting tube construction styles are more limited than thermowells. The tubes offer the advantages of economy, corrosion resistance and, in some cases, higher temperature capabilities.

### Protecting Tube Application Data

Material	Grade	Max. Use Air	Flexural Strength (X10 <sup>3</sup> psi)	Thermal Conduct. W/m.K 1475°K	Thermal Shock Resistance	Remarks	Typical Applications
Hexoloy SA®	Sintered	3000°F (1650°C)	67	54.0	Excellent	Maintains strength to 3002°F (1650°C), exceptional corrosion resistance, does <b>not</b> creep, attacked by halides, fused caustics and ferrous metals	Incineration, molten aluminum and non-ferrous metals, flue gas, hydrofluoric and sulfuric acids, bauxite calcining
Silicon Carbide	Oxide Bonded	3000°F (1650°C)		15-20	Good	Permeable	Non-ferrous metals
Alumina	99.9%	3450°F (1900°C)	50	6.3	Fair—preheating to 900°F (482°C) recommended	Creeps (sags) at 3452°F (1900°C) ferrous metals, dry H <sup>2</sup>	Barium, crown glass; non-ferrous metals; gas-tight protection for noble metal thermocouples in excess of 2400°F (1316°C)
	96%	3100°F (1700°C)	49	5.4	Same as above	Creeps at 3452°F (1900°C)	
Mullite	—	3100°F (1700°C)	12	2.1	Poor—must be preheated to 900°F (482°C)	Creeps at 3092°F (1700°C), attacked by halides—contains silica	Non-ferrous metals; gas-tight protection for base metal thermocouples to 2400°F (1316°C)
Metal Ceramic	LT-1	2500°F (1400°C)	45	29.0 (R.T.)	Must be preheated to 900°F (482°C) before immersion into molten metal at 1999°F (1093°C) or higher	Not recommended in carburizing, nitrogen atmospheres, high vacuum or in molten aluminum	Molten non-ferrous metals; calcining kilns, oxidizing atmospheres up to 2552°F (1400°C)
Coated Protection Tubes (SERIES 1100)		1400°F (760°C)			Excellent	Do not exceed 1400°F (760°C)	Molten aluminum, zinc and galvanizing; maximum operating temperature 1373°F (745°C)

**Note:** Please contact the factory for other mounting fittings availability.

**Note:** All accessories are subject to minimum purchase quantities.

# Accessories

## Protection Tubes

### Ceramic Protecting Tubes

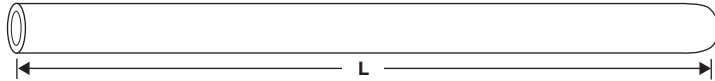

Mullite or Alumina Protecting Tube, Plain End

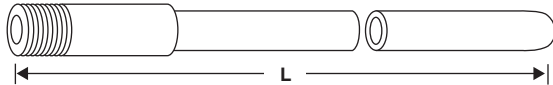

Mullite or Alumina Protecting Tube with TH-43 or TH-50 Ferrule

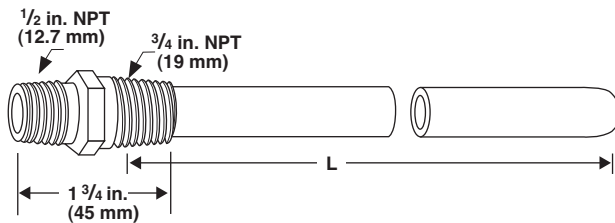

Mullite or Alumina Protecting Tube with TH-190 or TH-191 Fitting (3/4 inch of Tube Enters Fitting)

### Mullite Protecting Tubes

Part No.	I.D. X O.D. in.	Construction	Length in.
1152-	1/4 x 3/8	Plain end	12, 18, 24, 30, 36, 42, 48
1153-	7/16 x 11/16	Plain end	
1155-	3/4 x 1	Plain end	
1152-N-	1/4 x 3/8	With TH-50 ferrule 7/8 - 27 threads	
1153-N-	7/16 x 11/16	With TH-43 ferrule 7/8 - 27 threads	
1153-190-	7/16 x 11/16	With TH-190 1/2 x 3/4 in. brass	
1153-191-		With TH-191 1/2 x 3/4 in. steel	

Order - Part No. Code - Length

Example: 1152-12, 1152-N-12, 1153-191-24

### Alumina (99 Percent Minimum Purity) Protecting Tubes

Part No.	I.D. X O.D. in.	Construction	Length in.
1146	1/4 x 3/8	Plain end	12, 18, 24, 30, 36, 42
1147	7/16 x 11/16	Plain end	12, 18, 24, 30, 36, 42, 48
1146-N	1/4 x 3/8	TH-50 ferrule 7/8-27 threads	12, 18, 24, 30, 36, 42
1147-N	7/16 x 11/16	TH-43 ferrule 7/8-27 threads	12, 18, 24, 30, 36, 42
1147-190	7/16 x 11/16	With TH-190 1/2 x 3/4 in. brass	12, 18, 24, 30, 36, 42, 48
1147-191	7/16 x 11/16	With TH-191 1/2 x 3/4 in. steel	12, 18, 24, 30, 36, 42, 48

Dimension tolerance: Up to one inch, ±5 percent or 0.025 inch, whichever is greater; over one inch, ±4 percent or 0.050 inch, whichever is greater.

Order - Part No. Code - Length

Example: 1146-18, 1146-N-36, 1147-190-30

Note: All accessories are subject to minimum purchase quantities.

# Accessories

## Protection Tubes

### Coated Protection Tubes for Molten Aluminum, Zinc and Galvanizing Applications

#### SERIES 1100 Protection Tube

With a tough refractory laminated coating, SERIES 1100 protecting tubes resist erosion from molten aluminum, zinc or galvanizing baths. They stay strong, even at high temperatures and require no washing or maintenance to prolong their service life. A special protective cap at the tip provides fast response time, permitting thermal expansion without damage to the refractory laminate.

The 0.493 inch I.D. easily accommodates up to an 8-gauge beaded thermocouple and is stocked for immediate shipment. The maximum operating temperature for the SERIES 1100 is 1400°F (745°C).

**Order - Part No.** Code - Length

**Example:** 1100-24

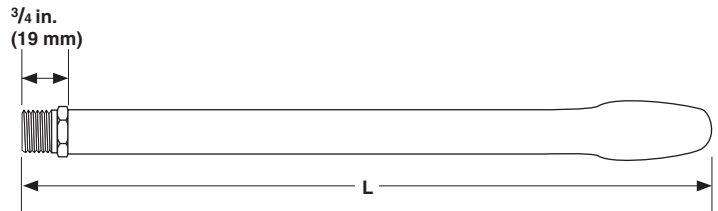

Part No.	I.D. in.	Nominal O.D. in.	Fitting in.	Tube Length in.
1100	0.493	1 1/2 Max.	3/4 NPT	12, 18, 24, 30, 36, 42, 48

#### SERIES 1101 Protection Thermocouple

Watlow's SERIES 1101 protected thermocouple assemblies incorporate a mineral-insulated stainless steel sheathed XACTPAK® thermocouple hermetically sealed within a refractory laminated SERIES 1100 protection tube. Standard calibration is Type K, complete with 36 inches of high temperature insulated thermocouple wire.

As with the SERIES 1100 protection tube, the SERIES 1101 assembly requires no washing or maintenance to prolong its service life. It delivers fast, accurate readings in molten aluminum, zinc and galvanizing baths.

**Order - Part No.** Code - Length

**Example:** 1101-12

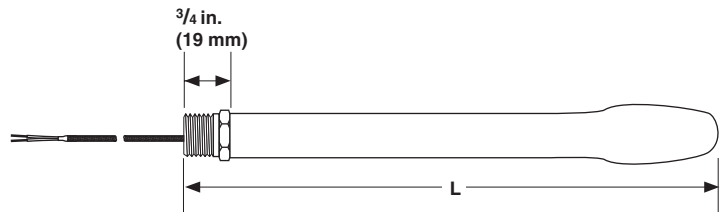

Part No.	Calibration	Nominal O.D. in.	Fitting in.	Lead Length in.	Tube Length in.
1101	K	1 1/2 Max.	3/4 NPT	36	12, 18, 24, 30, 36

**Note:** All accessories are subject to minimum purchase quantities.

# Accessories

## Protection Tubes

### Hexoloy SA® Tubes

#### Physical Properties of Hexoloy® Materials— Technical Data



Typical Values	Hexoloy® Grade
Physical Properties	SA
Composition* (Phases)	SiC
Density kg/m <sup>3</sup> (g/cm <sup>3</sup> )	3100 (3.10)
Hardness-Knopp (Kg/mm <sup>2</sup> )	2800
Flexural Strength 4 pt. @ RT** MPa (x 103 lb/in <sup>2</sup> )	460 (67)
Flexural Strength 3 pt. @ RT** MPa (x 103 lb/in <sup>2</sup> )	550 (80)
Compressive Strength RT MPa (x 103 lb/in <sup>2</sup> )	3900 (560)
Modulus of Elasticity RT GPa (x 106 lb/in <sup>2</sup> )	410 (59)
Weibull Modulus (2 Parameter)	10
Poisson Ratio	0.14
Fracture Toughness @ RT Double Torsion and SENB MPa/√m (x 103 lb/in <sup>2</sup> /√in)	4.60 (4.20)
Coefficient of Thermal Expansion 68°-1,292°F (RT-700°C) x 10 <sup>-6</sup> mm/mmK (x 10 <sup>-6</sup> in/in°F)	4.02 (2.20)
Maximum Service Temp. (Air) °C (°F)	1650 (3000)
Mean Specific Heat @ RT (J/gm K)	0.67
Thermal Conductivity @ RT W/m K (BTU/ft h °F)	125.6 (72.6)
Thermal Conductivity 200°C W/m K (BTU/ft h °F)	102.6 (59.3)
Thermal Conductivity 400°C W/m K (BTU/ft h °F)	77.5 (44.8)
Electrical Resistivity <sup>①</sup> RT, ohm-cm 1000°C, ohm-cm	0.2 to 300 <sup>①</sup> 0.01 to 0.2 <sup>①</sup>
Emissivity	0.9
Max Warpage	0.005/inch

\* Composition code: Si = Free Silicon Metal;  
C = Free Graphite; SiC = Silicon Carbide;  
TiB = Titanium Diboride

\*\* Test Bar Size: 1/8 x 1/4 x 2 inch (3.2 x 6.4 x  
50.8 mm), Outer Span = 1.5 inch;  
Inner Span = 0.75 inch

① Dependent upon dopants in Hexoloy SA® SiC which will decrease  
electrical resistivity to a desired range.

## How to Order

To order, specify the following part numbers and lengths required for your application.

**Order - Part No.** Code - Length

**Example:** 1040-12

Cemented mounting fittings are available for most tubes. Contact the factory or your local Watlow sales representative or distributor for information.

Part No.	O.D./I.D. in.	Lengths in.
1040	3/8 x 1/4	6, 12, 18, 24
1041	5/8 x 3/8	
1042	3/4 x 1/2	

## Tubes with Optional Mounting Fittings

Tube Part No.	Head Mount	Process Mount	Fitting Description	Lengths in.
1040-L	1/2 NPT	1/2 NPT	Cemented hex nipple	6, 12,
1041-M	3/4 NPT	3/4 NPT	Cemented hex nipple	18, 24
1042-P	3/4 NPT	3/4 NPT	Cemented hex nipple	

**Example:** 1041-M-24 is a 5/8 x 3/8 inch Hexoloy® tube 24 inches long with a single 3/4 inch NPT cemented hex fitting.

**Note:** The maximum recommended temperature rating for cemented fittings is 1000°F (538°C) continuous.

**Note:** All accessories are subject to minimum purchase quantities.

# Accessories

## Connectors

Many varieties of thermocouple connectors are available from Watlow. Watlow's broad offering includes benefits such as high impact strength, fast installation and high temperature capabilities.

Listed below are the various connectors and systems from which to choose:

- Standard thermocouple connectors
- Quick-attach thermocouple connectors
- High temperature connectors
- Three-pole connectors for RTD applications
- Miniature thermocouple connectors

Watlow's standard line of connectors are lightweight, rugged and accurate and feature a clamping mechanism that is unique in the industry.

This easy-to-use clamping connection will replace traditional screw and wire wrap. This device allows a straight-in application, which squeezes the wire and forms a tight connection assuring a clean, strong signal.

### Applications and Technical Data

To eliminate measuring errors, all Watlow connectors are made exclusively of matching metal alloys. If the connector material has different thermal electromagnetic field (EMF) characteristics from the thermocouple or lead wire, a uniform temperature must be maintained across the connector, which is not always easily achievable or practical.

If a temperature gradient exists across the connector made with a third metal, unwanted EMFs generate between the thermoelectric materials and the connector extremities causing an error to occur at the thermocouple output. The larger the gradient, the larger the error. In some instances, depending on the calibration, net errors may occur that are even larger than the gradient.

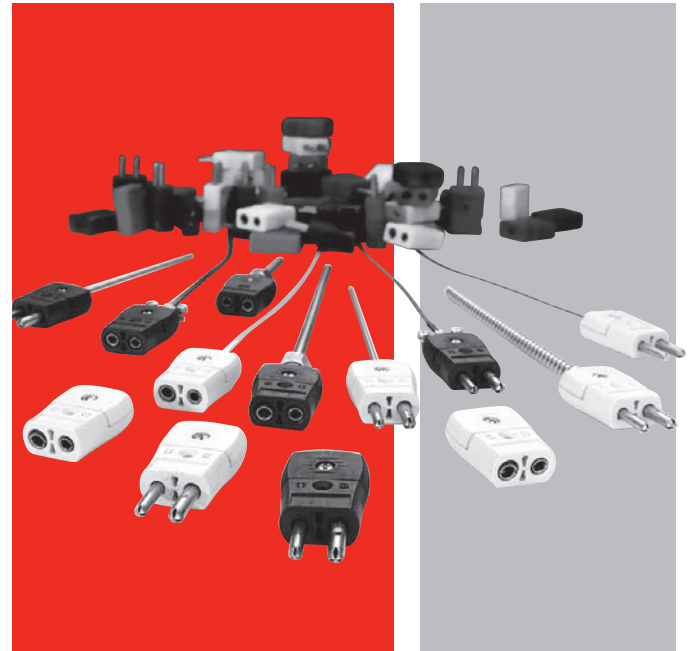

### Features and Benefits

#### ASTM color coded

- Ensures easy identification

#### Compensated alloys

- Provides accuracy in readings

#### Glass-filled thermoplastic

- Provides high impact strength

#### Captive cap screws

- Ensures a secure connection

#### Connection hardware

- Eliminates several components

#### Meets requirements for ASTM E1129

- Ensures adequate pin spacing, dimensions and contact resistance

#### Rated to 425°F (215°C)

- Fits high-temperature applications

**Note:** All accessories are subject to minimum purchase quantities.

# Accessories

## Connectors

### "S" SERIES Standard Connectors, 425°F (215°C)

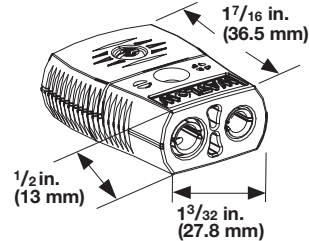
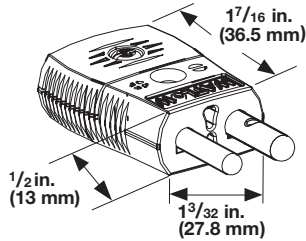

### Ordering Information

#### Part Number

① ②	③	④	⑤	⑥ ⑦
<b>SC</b>	Style	Calibration	Name Plate	Color Code

③ Style	
M =	Male (plug)
F =	Female (jack)

④ Calibration	
E =	Type E
J =	Type J
K =	Type K
S =	Type S / Type R
T =	Type T
U =	Uncompensated

⑤ Name Plate	
W =	With Watlow name
N =	Without name label (For J and K calibration only)

⑥ ⑦ Color Code	
AT =	ASTM E 230 color code

### Cable Clamp Style for Male or Female

Part Number: **SAC-220**

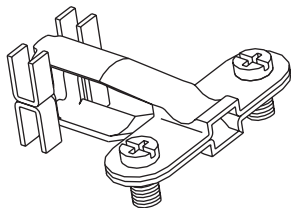

### Crimp/Brass Style

#### Ordering Information

##### Part Number

① ② ③	④ ⑤ ⑥
<b>SAB</b>	Style

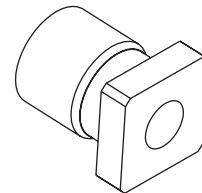

④ ⑤ ⑥ Style		
040 =	0.040 in.	
063 =	0.063 in.	
090 =	0.090 in.	
125 =	0.125 in.	
188 =	0.188 in.	
250 =	0.250 in.	
30M =	3.0 mm	
60M =	6.0 mm	

**Note:** All accessories are subject to minimum purchase quantities.



# Accessories

## Connectors

### Quick-Attach Thermocouple Connectors, 425° F (215°C)

Watlow's time-saving thermocouple connectors are quick and convenient to use because there are no loose parts and there is no need to remove caps or wrap wires around terminal screws. Stripped wire ends are simply inserted into a plug or jack then tightened with two terminal screws.

Thermocouple connectors accept solid or stranded wires up to 16 gauge, are available in Type J, K and T calibrations and are ASTM E 230 color-coded. The connector is made with high-impact strength, 425°F (215°C) rated glass filled thermoplastic with matching thermocouple materials. Other features and specifications are identical to standard Watlow "S" SERIES quick-disconnect connectors.

#### Step 1.

Simply insert stripped wires into connector.

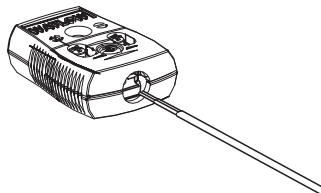

#### Step 2.

Tighten two terminal screws.

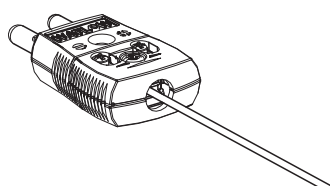

## Ordering Information

### Part Number

1 2	3	4	5	6 7	8 9 10 11
SK	Style	Calibration	Name Plate	Color Code	Assembly
			W	AT	ASSY

3 Style	
M =	Male (plug)
F =	Female (jack)

4 Calibration	
J =	Type J
K =	Type K
T =	Type T

5 Name Plate	
W =	With Watlow name

6 7 Color Code	
AT =	ASTM E 230 color code

8 9 10 11 Assembly	
ASSY =	Comes with cap assembly on body

## Weather Resistant Boots

Used in pairs as illustrated, these flexible neoprene rubber boots add moisture protection to standard plug-to-jack connections.

Part No. 943

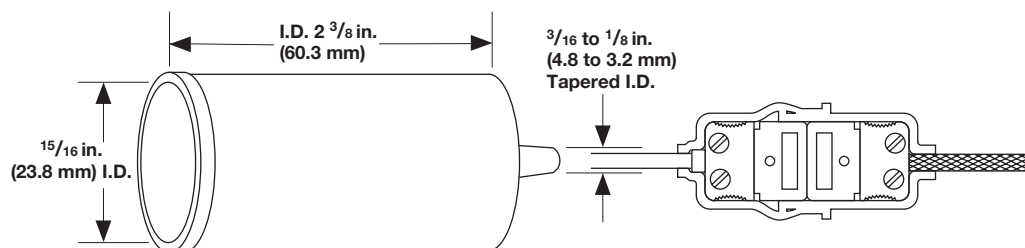

**Note:** All accessories are subject to minimum purchase quantities.

# Accessories

## Connectors

### High-Temperature Connectors 1000°F (540°C)

The ASTM E 230 color-coded bodies of these high temperature ceramic connectors are practical for temperatures up to 1000°F (540°C). Colors are permanent and will not fade even after exposure to temperature. The positive-locking screw type terminals are captive for easy assembly. Solid plug pins and collet inserts are made of thermocouple alloys (except Type R/S which is compensated).

Calibration must be specified when ordering. Both plug and jack are marked for polarity and standard  $\frac{7}{16}$  inch pin spacing.

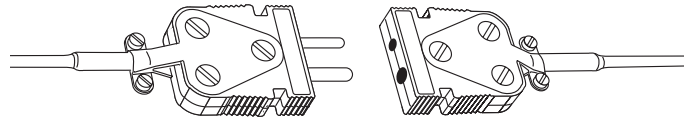

Part Number	Description
912-*	Ceramic plug (specify calibration J, K, R/S or E)
913-*	Ceramic jack (specify calibration J, K, R/S or E)
925-125	XACTPAK adapter for plug or jack (0.125 inch sheath O.D.)
925-188	XACTPAK adapter for plug or jack (0.188 inch sheath O.D.)
925-250	XACTPAK adapter for plug or jack (0.250 inch sheath O.D.)
926	Cable clamp for ceramic plug or jack

\*Insert calibration letter for full part number 912-J

### Three-Pole Connectors for RTD Applications, 400°F (200°C)

- Three pins to accommodate most RTD sensor applications
- Rated up to 400°F (200°C) continuous
- Jacks have spring-loaded inserts for positive contact
- Larger diameter negative pin prevents user from reversing polarity

Part Number	Description
TH-335	3-pole connector plug with copper pins
TH-336	3-pole connector jack with copper inserts
TH-337-125	Compression-type adapter for 0.125 inch tube
TH-337-188	Compression-type adapter for 0.188 inch tube
TH-337-250	Compression-type adapter for 0.250 inch tube
80701201	Cable clamp for 3-pole connector

#### Plug

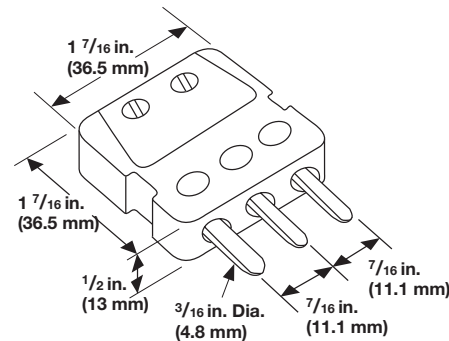

#### Jack

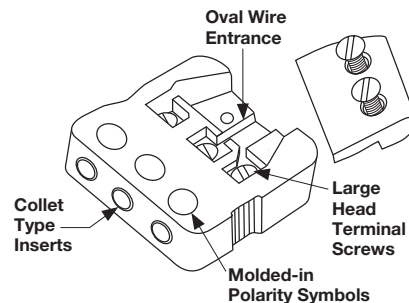

**Note:** All accessories are subject to minimum purchase quantities.

# Accessories

## Connectors

### Miniature Thermocouple Connector System, 400°F (200°C)

Watlow's new miniature connector is for both thermocouple and RTD circuits. This connector is suited for small wires or small diameter mineral insulated cables. The connector features a glass filled high quality thermoplastic body that makes for a more rugged and durable connector. Matching thermocouple alloys and spring loaded pin inserts ensure an accurate and strong signal. Captive terminal screws and molded polarity signals make for faster and easier wire termination with less error. Watlow's new miniature plugs and jacks will mate with previous Watlow miniature connectors and any other ANSI spec miniature connector.

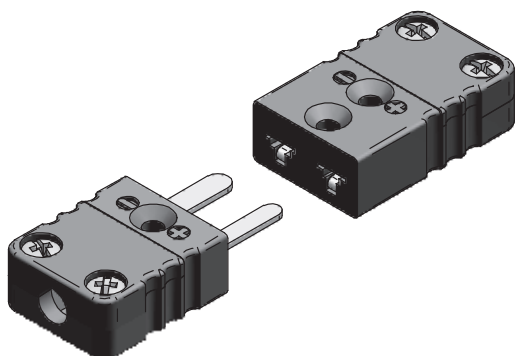

### Ordering Information

#### Part Number

① ②	③	④	⑤	⑥ ⑦
MC	Style	Calibration	Name Plate	Color Code
MC			N	AT

#### ③ Style

M =	Male (plug)
F =	Female (jack)

#### ④ Calibration

E =	Type E
J =	Type J
K =	Type K
N =	Type N
R =	Type R
S =	Type S
T =	Type T
U =	Uncompensated

#### ⑤ Name Plate

N =	Without name
-----	--------------

#### ⑥ ⑦ Color Code

AT =	ASTM E230 color code/uncompensated = white
------	--------------------------------------------

## Accessories

### Crimp/Braze Adapter

These adapters are designed for brazing, soldering or crimping on mineral insulated cable or crimping onto insulated wire.

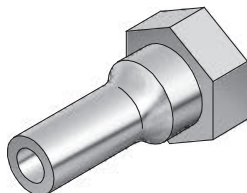

### Ordering Information

#### Part Number

① ② ③	④ ⑤ ⑥
MHX	Sheath Size
MHX	

#### ④ ⑤ ⑥ Sheath Size

032 =	0.032
040 =	0.040
063 =	0.063
125 =	0.125

### Grommets

Grommets can be fitted in the entrance hole of the connector to prevent moisture and dirt from entering the connector. All grommets are constructed from silicone with a maximum temperature of 400°F (200°C) and are pre-slit to allow for easy installation. These grommets will compress on the wire once the cover is fitted.

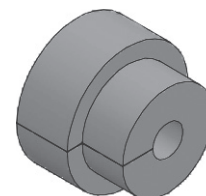

### Ordering Information

Part Number	Description
71305601	Grommet with 0.12 in. (3.0 mm) diameter
71305602	Grommet with 0.02 in. (0.5 mm) diameter
71305603	Grommet with 0.06 in. (1.5 mm) diameter

**Note:** All accessories are subject to minimum purchase quantities.

# Accessories

## Connectors

### Miniature Thermocouple Connector System, 400°F (200°C)

#### Ordering Information

Description	① ② Connector Type	③ Style	④ Available Calibration	⑤ Name Plate	⑥ ⑦ Color Code
Locking connectors that prevent plug and jack separation in high vibration environments	ML	M, F	E, J, K, N, R, S, T, U	N	AT
High temperature connectors rated for 800°F (427°C)	MH	M, F	E, J, K, N, R, S	N	AT*
Three pin connectors for grounded/shielded thermocouples and RTD circuits	MT	M, F	E, J, K, N, R, S, T, U	N	AT
Panel inserts suitable for instrumentation cases	MP	C, R **	J, K, T	N	AT

\*High temperature connectors are stamped with the calibration type.

\*\*Panel inserts are available in both circular and rectangular configurations.

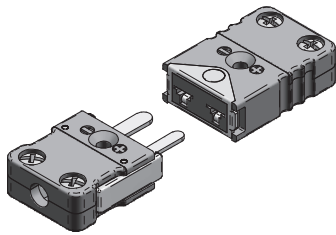

Locking Miniature Connectors

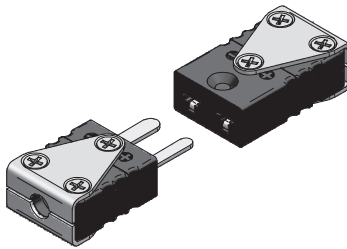

High Temperature Miniature Connectors

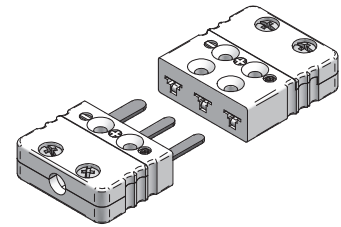

Miniature Three Pin Connectors

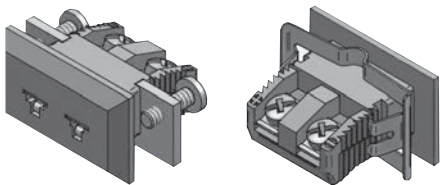

Rectangular Miniature Panel Inserts

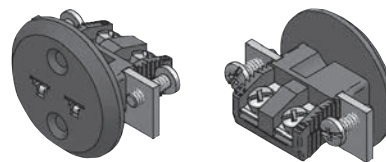

Circular Miniature Panel Inserts

#### Additional Accessories

Part Number	Description
80441501	Locking clips are a cost effective way to prevent accidental plug and jack separation
80441301	Wire clamp bracket provides optimum strain relief with a large range of maximum and minimum wire diameters

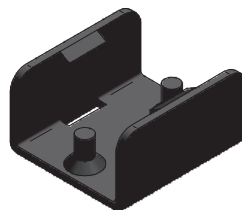

Miniature Connector Locking Clips

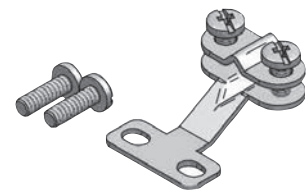

Wire Clamp

For dimensional drawings of all connector types please review Watlow's "[Miniature Connector Spec Sheet.](#)"

**Note:** All accessories are subject to minimum purchase quantities.

# Accessories

## Connectors

### Single Panel Mount Hardware, 425°F (218°C)

Designed for use with Watlow's "S" standard thermocouple connectors, these units fit panels up to  $\frac{7}{16}$  inch thick. Panel cutout:  $1\frac{1}{8}$  inch to  $1\frac{5}{32}$  inch hole. Units fit into standard  $\frac{3}{4}$  inch knockouts.

### Ordering Information

#### Part Number

①	②	③	④	⑤	⑥	⑦
SKP			Calibration	Name Plate	Color Code	

④ Calibration	
J	Type J
K	Type K
T	Type T

⑤ Name Plate	
W	With Watlow name

⑥ ⑦ Color Code	
AT	ASTM E 230 color code/uncompensated = white

#### SKP Style

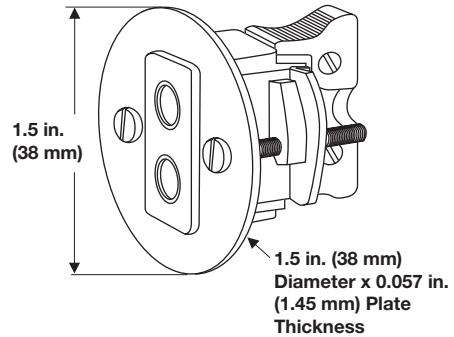

Single circuit panel mount with quick-disconnect jack included. Available calibrations J, K, T, R/S and Cu/cu.

#### SNP Style

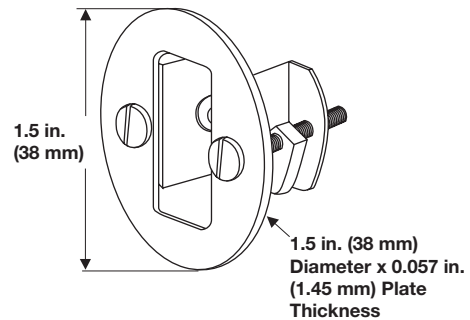

Panel mount hardware only without Watlow name.

**Note:** All accessories are subject to minimum purchase quantities.

# Accessories

## Connection Heads and Blocks

### Standard Thermocouple Connection Heads

(Assembly ordering options D or E)

Watlow's standard heads are made of cast iron or aluminum. A plated chain attaches the gasketed cover to the body. Flats are provided for tightening. The connector block, held in place with two screws, can be single, duplex or triplex. These heads have 1, 3/4 or 1/2 inch NPT openings for protecting tubes or drilled wells. The conduit outlet is 3/4 inch NPT. Epoxy coating is available on the aluminum head. Maximum operating temperature is 825°F (441°C). Approved for NEMA 4X, IP66.

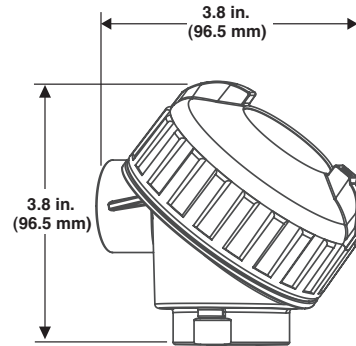

Approximate Assembled Dimensions:  
3.8 in. (96.5 mm) H x 3.8 in. (96.5 mm) L x  
3.8 in. (96.5 mm) W

Cast Iron Head Only Part No.	Aluminum Head Only Part No.	Sensor Opening (NPT) in.	Conduit Connection in.
70900201	—	1	3/4
70900202	—	3/4	3/4
70900203	70900301*	1/2	3/4

\*Available with epoxy coating (70900302)

### Terminal Blocks for Standard Connection Heads

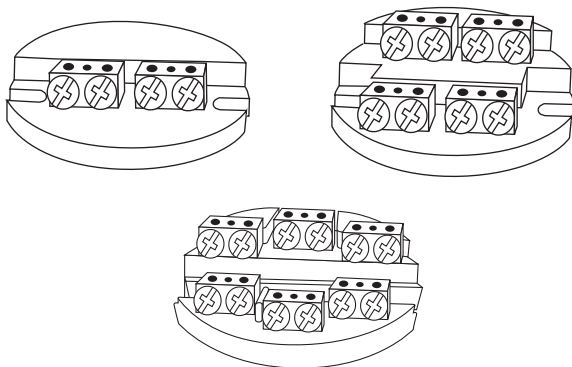

Part No.	Description
50500401	Single element, max. operating temperature 1000°F (540°C)
50500501	Dual, max. operating temperature 1000°F (540°C)
50500601	Triplex, max. operating temperature 1000°F (540°C)

### Barrier Type Terminal Strips

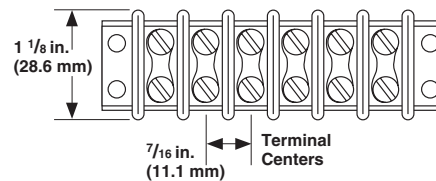

Standard barrier type terminal strips made of molded phenolic blocks with nickel plated brass terminals are available with two to 18 terminals and a temperature range of -55 to 300°F (-48 to 149°C). Terminal strips using thermocouple material also are available. **Note:** Two terminals required for each thermocouple.

### Ordering Information:

Specify 4201- \_\_\_\_\_ -BR

Insert the number of terminals desired (02 to 18) in the blank. For terminals of thermocouple material, insert thermocouple calibration symbol in place of BR (K, J, E, T and R/S). Terminal strips then will be supplied with alternate positive and negative strips.

**Note:** All accessories are subject to minimum purchase quantities.

# Accessories

## Connection Heads and Blocks

### Explosion Proof Thermocouple Connection Heads

(Assembly ordering option H)

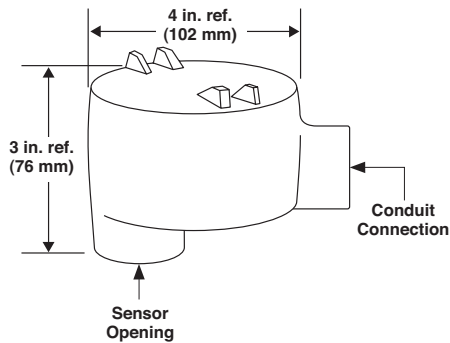

Approximate Assembled Dimensions:  
4 in. H x 2 1/4 in. L x 3 in. W

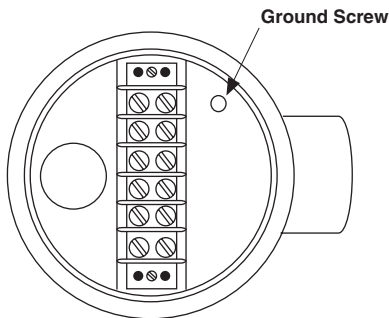

XP Head Shown with TH-615 Block

Part No.	Sensor Opening in.	Conduit Connection in.
XP-11	3/4	3/4
XP-12	1/2	3/4

For hazardous locations. Underwriter's Laboratories Listed Class 1, Groups C, D; Class 2, Groups E, F, G; Class 3, all Groups.

All XP explosion-proof heads use a TH-615 (six terminal) block.

**Order separately.**

Also approved for CSA Class I, Groups C and D; Class II, Groups E and F; and Class III.

### PT Polypropylene Head and Connector Blocks

(Assembly ordering option C)

The polypropylene head is the answer to many of the corrosion problems facing connection heads. The U.V. stabilized polypropylene head is impervious to practically all corrosive media and is rated for continuous operation up to 220°F (105°C). The PT-20 and PT-30 are colored black and the RT-30-WHT is white.

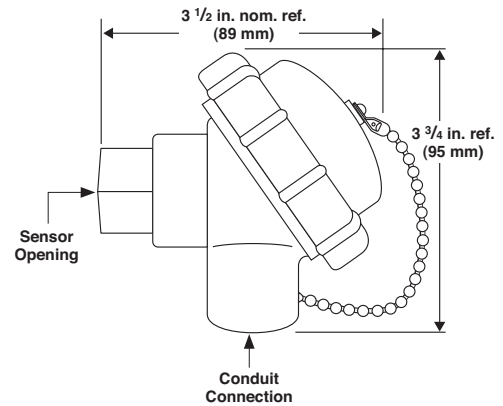

### PT Polypropylene Heads

Part No. Head Only	Sensor Opening in.	Conduit Connection in.
PT-20	1/2	1/2
PT-30	1/2	3/4
RT-30-WHT	1/2	3/4

### Terminal Blocks for PT Heads

Part No.	Description
50500701	Single element block
50500801	Dual element block

**Note:** All accessories are subject to minimum purchase quantities.

# Accessories

## Transmitters

### SERIES 5750

The SERIES 5750 temperature transmitter from Watlow offers remarkably accurate temperature measurement and improves reliability to reduce downtime and costs.

The SERIES 5750 offers new measurements with resistance temperature detectors (RTDs) in three and four-wire connections. It is designed to fit directly inside connection heads type DIN B or larger.

The transmitter is programmed using a separate connection cable and an easy-to-use Windows®-based software program configures the transmitter in seconds.

The SERIES 5750 provides linearization between temperature sensor input signals and the 4-20 mA output signal to ensure accurate temperature measurements across a broad range.

Contact Watlow's customer service department to integrate this transmitter into a Watlow Style AR or AT thermocouple sensor or with a Style RR or RT RTD sensor.



### Features and Benefits

#### Accepts three and four-wire RTD and thermocouple sensor inputs

- Standardizes transmitter for various sensors and applications

#### Designed for harsh conditions

- Withstands high vibration and high humidity applications

#### Sensor error compensation function

- Provides convenience for adjusting the sensor/transmitter combination, or the transmitter alone, ensuring accurate temperature measurement within a specific range

#### Large center hole and robust terminals with test connections and low height

- Enables easy mounting

#### Configuration without external power

- Allows configurations to be edited or read offline by connecting to a personal computer (PC) universal serial bus (USB) port

#### Easy-to-use Windows® configuration software

- Parameters such as sensor type, measuring range, filter activation, cold junction compensation, sensor failure and error corrections are set in one window

**Note:** All accessories are subject to minimum purchase quantities.



# Accessories

## Transmitters

### SERIES 5750

#### Specifications

##### Input RTD

- Pt100 (IEC 60751,  $\alpha = 0.00385$ )  
-328 to +1832°F (-200 to +1000°C)
- Pt100 (JIS C 1604,  $\alpha = 0.003916$ )  
-328 to +1832°F (-200 to +1000°C)
- Pt1000 (IEC 60751,  $\alpha = 0.00385$ )  
-328 to +392°F (-200 to +200°C)
- 3-, 4-wire connection
- Sensor current ~ 0.4mA
- Max. sensor wire resistance 25Ω/wire

##### Input Thermocouples

- Range Type: B, C, E, J, K, N, R, S, T
- Max. sensor wire resistance 500Ω (total loop)

##### Monitoring

- Sensor failure monitoring upscale or downscale action

##### Adjustments

- Zero adjustments for all inputs at any value within temperature range limits
- Min. spans: Pt input 18°F (10°C)  
T/C 2mV

##### Output

- Analog 4-20mA, temperature linear
- Resolution 5μA
- Min. output signal measurement/failure 3.8mA/3.5mA
- Max. output signal measurement/failure 20.5mA/21.6mA
- Permissible load, see load diagram 725Ω @ 24VDC

##### Temperature

- Ambient, storage and operation  
-40 to +185°F (-40 to +85°C)

##### General Data

- Selectable dampening time ~ 2s
- Update time ~ 1.5s
- Isolation in - out non-isolated
- Humidity 0 to 100% RH
- Vibration acc. to IEC 60068-2-6, test Fc,  
60-500Hz, 10g
- Output limitations and fail currents are NAMUR compliant

##### Power Supply

- Polarity protected
- Supply voltage 8 to 32VDC
- Permissible ripple 4V p-p @ 50/60Hz

##### Accuracy

- Linearity RTD  $\pm 0.1\%$ <sup>①</sup>  
T/C  $\pm 0.2\%$ <sup>①</sup>
- Calibration RTD max. of  $\pm 0.4^\circ\text{F}$  /  $\pm 0.2^\circ\text{C}$  or  $\pm 0.1\%$ <sup>①</sup>  
T/C max. of  $\pm 20\mu\text{V}$  or  $\pm 0.1\%$ <sup>①</sup>
- Cold junction compensation (CJC) T/C  $\pm 0.9^\circ\text{F}$  ( $\pm 0.5^\circ\text{C}$ )
- Temperature influence<sup>③</sup> All inputs max. of  $\pm 0.25^\circ\text{C}/25^\circ\text{C}$  or  $\pm 0.25\%/25^\circ\text{C}$ <sup>②</sup>
- Max. of  $\pm 0.5^\circ\text{F}/50^\circ\text{F}$  or  $\pm 0.28\%/50^\circ\text{F}$ <sup>① ②</sup>

##### Housing

- Material, Flammability (UL<sup>®</sup>) PC/ABS + PA, V0
- Mounting DIN B-head or larger, DIN rail (with mounting kit)
- Connection single/stranded wires max. 1.5 mm<sup>2</sup>, AWG 16
- Weight 32g
- Protection, housing / terminals IP 65/IP 00

<sup>①</sup> Of input span

<sup>②</sup> If zero-deflection >100% of input span: add 0.125% of input span/  
25°C or 0.14% of input span/50°F per 100% zero-deflection

<sup>③</sup> Reference temperature 68°F (20°C)

#### Input Connections

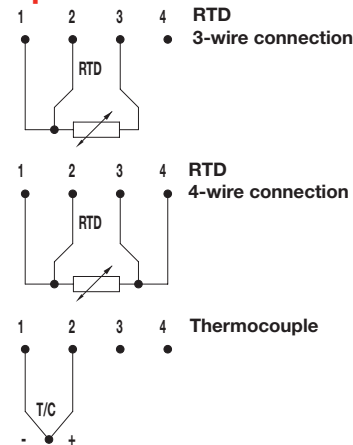

#### Output Connections

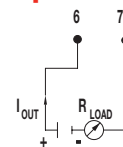

#### Dimensional Drawing

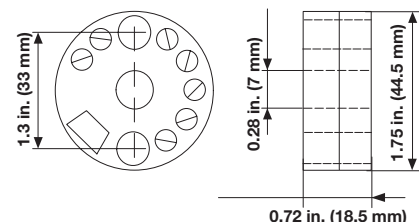

**Note:** All accessories are subject to minimum purchase quantities.

# Accessories

## Transmitters

### SERIES 5750

### Ordering Information

#### Part Number

① ② ③ ④	⑤	⑥	⑦ ⑧ ⑨	⑩	⑪ ⑫ ⑬ ⑭	⑮
SERIES	Sensor Type	Low Temp. Sign	Low Temp.	High Temp. Sign	High Temp.	Unit of Measure
5750						

① ② ③ ④	SERIES
5750	= Linearized T/C or RTD

⑤	Sensor Type
B	= Type B T/C
C	= Type C T/C
E	= Type E T/C
J	= Type J T/C
K	= Type K T/C
N	= Type N T/C
R	= Type R T/C
S	= Type S T/C
T	= Type T T/C
0	= PT100 (IEC 60751, $\alpha = 0.00385$ ) 3-wire
1	= PT100 (JIS C 1604, $\alpha = 0.003916$ ) 3-wire
2	= PT100 (IEC 60751, $\alpha = 0.00385$ ) 4-wire
3	= PT100 (JIS C 1604, $\alpha = 0.003916$ ) 4-wire
4	= PT1000 (IEC 60751, $\alpha = 0.00385$ ) 3-wire
5	= PT1000 (IEC 60751, $\alpha = 0.00385$ ) 4-wire

⑥	Low Temperature Sign
	Enter + or - sign

⑦ ⑧ ⑨	Low Temperature
	Enter lower limit temperature required

⑩	High Temperature Sign
	Enter + or - sign

⑪ ⑫ ⑬ ⑭	High Temperature
	Enter higher limit temperature required

⑮	Unit of Measure
	Enter °F or °C

**Program cable and software part #5750-CABLE (required for optional future changes)**

**Note:** All accessories are subject to minimum purchase quantities.

# Accessories

## Transmitters

### **SERIES 5900 (Isolated)**

Watlow's SERIES 5900 temperature transmitter delivers remarkably accurate temperature measurement and improves reliability to reduce downtime and costs.

The 5900 SERIES two-wire signal conditioner uses surface mount and digital technology with non-volatile memory. It is designed to fit directly into universal aluminum or universal iron connection heads with a separate mounting kit.

The transmitter is programmed using a separate connection cable and an easy-to-use Windows®-based software program. There is no need to use a separate thermocouple/RTD calibrator or individual resistors.

The SERIES 5900 is isolated to 1500VAC and features full linearization between temperature sensor input signal and the 4-20mA output signal. Isolated transmitters provide isolation from input to output thus eliminating ground loops and signal integrity.

Additional options include insulation resistance monitoring between sensor and ground to prevent inaccurate measurements due to insulation breakdown.

Contact Watlow's customer service department to integrate this transmitter into a Watlow Style AR or AT thermocouple sensor or a Watlow Style RR or RT RTD sensor.

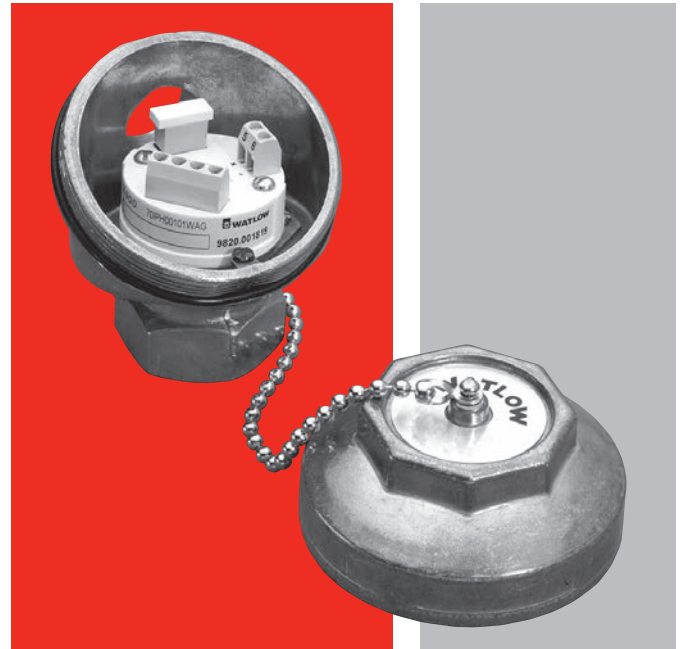

### **Features and Benefits**

#### **Full temperature to thermocouple signal linearization throughout the complete operation temperature span**

- Ensures signal accuracy

#### **Full isolation from input to output**

- Eliminates ground loops for high data integrity

#### **Fits directly into connection head**

- Easy to install

#### **Programmable**

- Ensures greater convenience for future changes and inventory efficiency

#### **User selectable input types**

- Thermocouple calibration Types B, C, E, J, K, N, R, S and T; RTD Pt100 and Pt1000 including four-wire

#### **Optional insulation resistance monitoring**

- Prevents inaccurate measurements due to insulation breakdown

#### **CE marked**

- Compliant to electromagnetic interference

**Note:** All accessories are subject to minimum purchase quantities.

# Accessories

## Transmitters

### SERIES 5900 (Isolated)

#### Specifications

- Isolation: 1500VAC for one minute
- Operating voltage: 6.5 to 36 volts (the 5900 is protected against voltage surges and reverse polarity)
- Sensor burn out protection: A pulsed current continuously checks all sensor leads for disconnect. The output will go upscale or downscale.
- Minimum input signal: RTDs: 10°C, Thermocouples: 2mV
- Operating temperature: -40 to 85°C
- Response time approximately: 0.5 seconds
- RFI sensitive: 20 - 1000 MHz, 10V/m typical <0.1% (of end value)
- Permissible ripple of supply: 4V p-p
- Long-term stability: 0.1% per year
- Calibration inaccuracy, thermocouples: max. of 20μ volts or 0.01%
- Temperature effect: cold junction compensation 0.02% C/C
- Housing: PC, ABS/VO connection polyamid / V2
- Mounting: DIN B

#### Dimensional Drawings

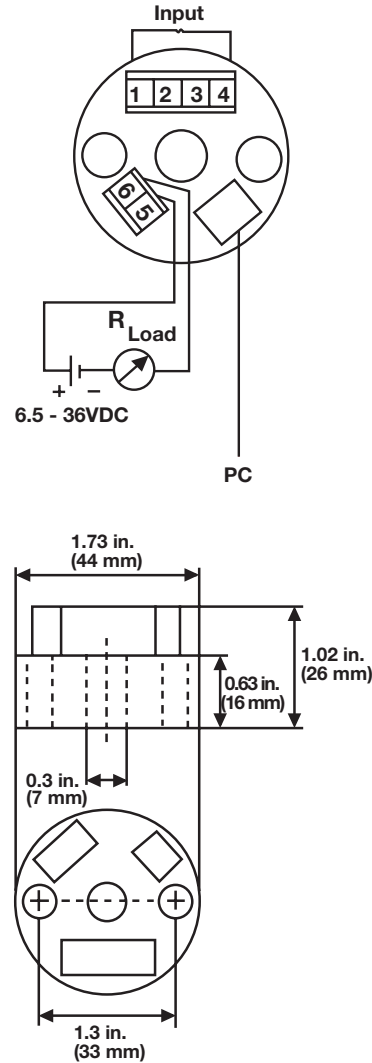

#### Wiring Diagram

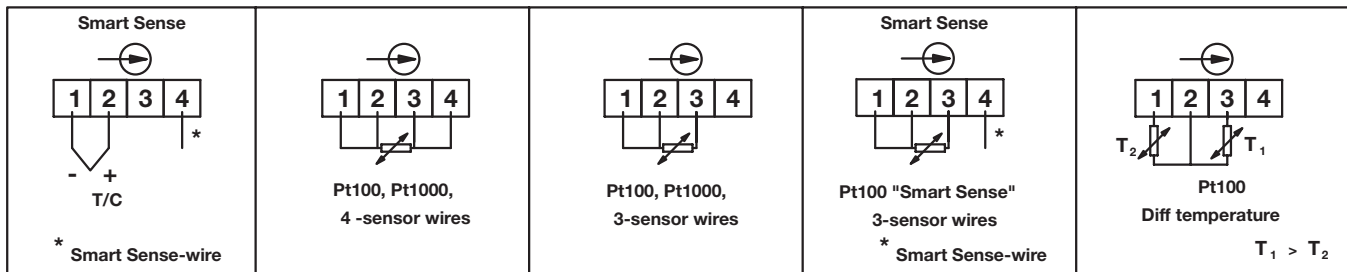

**Note:** All accessories are subject to minimum purchase quantities.

# Accessories

## Transmitters

### SERIES 5900 (Isolated)

### Ordering Information

#### Part Number

① ② ③ ④	⑤	⑥	⑦ ⑧ ⑨	⑩	⑪ ⑫ ⑬ ⑭	⑮
SERIES	Sensor Type	Low Temp. Sign	Low Temp.	High Temp. Sign	High Temp.	Unit of Measure

① ② ③ ④	SERIES
5900 =	Linearized T/C or RTD
5901 =	1000Ω RTD
5902 =	Isolated, linearized with insulation resistance monitoring

⑤	Sensor Type
B =	Type B T/C
C =	Type C T/C
E =	Type E T/C
J =	Type J T/C
K =	Type K T/C
N =	Type N T/C
R =	Type R T/C
S =	Type S T/C
T =	Type T T/C
0 =	PT100 (IEC 60751, $\alpha = 0.00385$ ) 3-wire
1 =	PT100 (JIS C 1604, $\alpha = 0.003916$ ) 3-wire
2 =	PT100 (IEC 60751, $\alpha = 0.00385$ ) 4-wire
3 =	PT100 (JIS C 1604, $\alpha = 0.003916$ ) 4-wire
4* =	PT1000 (IEC 60751, $\alpha = 0.00385$ ) 3-wire
5* =	PT1000 (IEC 60751, $\alpha = 0.00385$ ) 4-wire

\* Only valid options for 5901 SERIES

⑥	Low Temperature Sign
	Enter + or - sign

⑦ ⑧ ⑨	Low Temperature
	Enter lower limit temperature required

⑩	High Temperature Sign
	Enter + or - sign

⑪ ⑫ ⑬ ⑭	High Temperature
	Enter higher limit temperature required

⑮	Unit of Measure
	Enter °F or °C

**Program cable and software part #5900-CABLE**

**Note:** All accessories are subject to minimum purchase quantities.

# Accessories

## Transmitters

### System Components

### Typical Wiring Diagrams for Two-Wire Signal Conditioners

#### Controller or PLC with 4-20mA Input

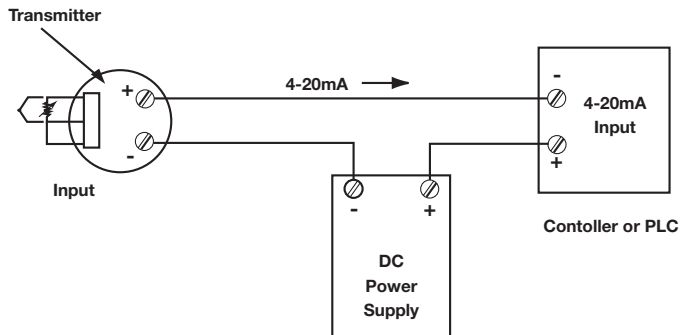

#### Controller or PLC with 1 to 5 Volt Input

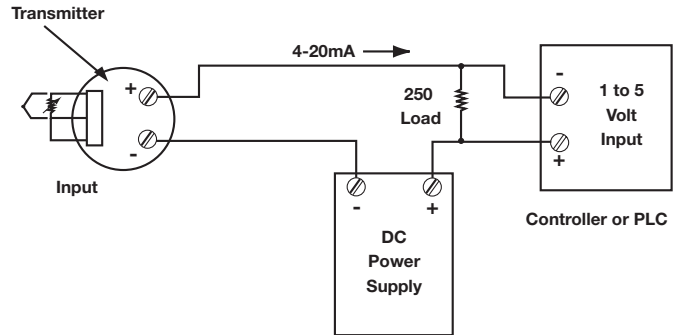

#### Controller or PLC with Intergal Power Supply

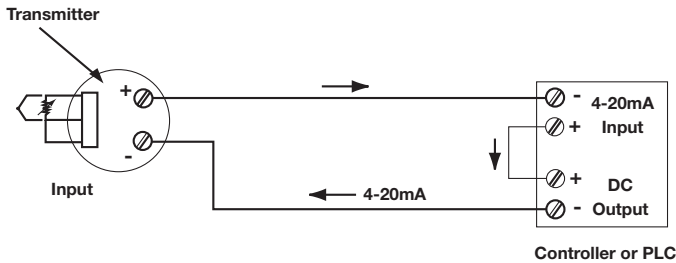

## Transmitter and Connection Head Mounting Options

Signal Conditioner Model and Description	Connection Heads			
	Cast Aluminum	Cast Iron	Explosion XP SERIES	Poly Heads Pt SERIES
5750, Non-isolated, Non-linearized	Mount with kit <b>81501901</b>	Does not fit	Mount with kit <b>81501301</b>	Mount with kit <b>81501201</b>
5900, 5901 and 5902, Isolated, Linearized	Mount with kit <b>81501901</b>	Does not fit	Mount with kit <b>81501301</b>	Mount with kit <b>81501201</b>

**Note:** All accessories are subject to minimum purchase quantities.

Product	Description	Page
<b>Thermocouple and Extension Wire</b>	Single pairs of thermocouple conductors are available using a variety of insulation materials. Matched pairs with duplex insulation are color coded according to ANSI MC 96.1-1982 requirements. The operating temperature rating for thermocouple and extension wire is up to 2600°F (1427°C).	<b>143</b>
<b>RTD Lead Wire</b>	Nickel or tin plated 2, 3 and 4-wire copper conductor constructions are available in a variety of gauge sizes. All types are twisted to achieve maximum reduction of electromagnetic interferences, are available with PVC, FEP, PFA or fiberglass insulations and are color coded according to ANSI requirements.	<b>178</b>



## General Information

### Thermocouple and Extension Wire Color Codes

#### United States and International Color Coding

Standard ASTM E 230 color coding (United States) is used on all insulated thermocouple wire and extension wire when insulation type permits. In color coding, the right is reserved to include a tracer to identify the ASTM E 230 type. Thermocouple grade wire normally has a brown overall jacket. For Types R and S, the color codes correlate to the compensating cable normally used.

Various national and international standard agencies have adopted color codes for identifying thermocouples which generally differ from those specified in ASTM E 230. The overall extension color code is also used to identify connectors to specific thermocouple types.

#### Thermocouple and Extension Wire Color Codes

Overall/Positive (+)/Negative (-)

ANSI Code	ANSI/ASTM T/C	ANSI/ASTM Extension	BS 1843 (Britain)	DIN 43714 (Germany)	JIS C1610-1981 (Japan)	IEC 584-3 (Europe)
B (overall)	—	Gray	—	—	Gray	—
BP	—	+Gray	—	—	+Red	—
BN	—	-Red	—	—	-White	—
E (overall)	Brown	Purple	Brown	Black	Purple	Violet
EP	+Purple	+Purple	+Brown	+Red	+Red	+Violet
EN	-Red	-Red	-Blue	-Black	-White	-White
J (overall)	Brown	Black	Black	Blue	Yellow	Black
JP	+White	+White	+Yellow	+Red	+Red	+Black
JN	-Red	-Red	-Blue	-Blue	-White	-White
K (overall)	Brown	Yellow	Red	Green	Blue	Green
KP	+Yellow	+Yellow	+Brown	+Red	+Red	+Green
KN	-Red	-Red	-Blue	-Green	-White	-White
N (overall)	Brown	Orange	Orange	—	—	Pink
NP	+Orange	+Orange	+Orange	—	—	+Pink
NN	-Red	-Red	-Blue	—	—	-White
R (overall)	—	Green	Green	White	Black	Orange
RP	—	+Black	+White	+Red	+Red	+Orange
RN	—	-Red	-Blue	-White	-White	-White
S (overall)	—	Green	Green	White	Black	Orange
SP	—	+Black	+White	+Red	+Red	+Orange
SN	—	-Red	-Blue	-White	-White	-White
T (overall)	Brown	Blue	Blue	Brown	Brown	Brown
TP	+Blue	+Blue	+White	+Red	+Red	+Brown
TN	-Red	-Red	-Blue	-Brown	-White	-White



# SERV-RITE Wire

## Thermocouple and Extension Wire

### Manufactured to Exact Specifications

Since 1914, SERV-RITE® thermocouple wire and thermocouple extension wire have been recognized for premium performance and reliability. All stock and custom wire is manufactured in Watlow's plant where materials, manufacturing equipment and quality controls are carefully selected to ensure superior uniformity.

Watlow offers popular wires as well as custom manufactured wire using alloys and insulation types to meet specific application demands.

All SERV-RITE thermocouple wire and thermocouple extension wire is manufactured under rigid quality controls following ISO 9001 standards. In addition, all electromotive force (EMF) versus temperature calibration procedures follow one or more of the following standards:

- ASTM E 207
- ASTM E 220
- AMS 2750

All testing has NIST traceability. Unless otherwise specified, all SERV-RITE thermocouple wire and extension wire are supplied to meet standard tolerances of ASTM E 230. Special tolerances are also available.

### Performance Capabilities

- Compliance with recognized agency tolerances
- Insulation temperature ranges from -328 to 2600°F (-200 to 1427°C)
- Tolerances from  $\pm 0.5^\circ\text{C}$  or  $\pm 0.4$  percent
- NIST calibration certificates
- ISO 17025 Accredited Lab



### Features and Benefits

#### Type E, J, K, N, S and T thermocouple wire

- Fit virtually all applications

#### Compensation extension wire

- Permits fine tuning of temperature measuring circuits

#### Solid or stranded wire

- Meets specific application requirements

#### Wide selection of insulation types

- Meets temperature, chemical, moisture and abrasion resistance objectives

#### Color coding

- Complies with United States, United Kingdom, German, Japanese and IEC standards

#### Metallic overbraids and wraps

- Enhance abrasion resistance

#### Stock RTD lead wire

- Meets virtually all industrial RTD applications

# SERV-RITE Wire

## Thermocouple and Extension Wire



### Stock Wire Products by Temperature

Thermocouple Wire Max. Opr. Temp.		Insulation	Part Number	Limits of Error	Description	Physical Properties		
°F	°C					Abrasion Resistance	Moisture Resistance	Chemical Resistance
2600	1427	Ceramic	K20-1-350	Standard	Brd. C. Fbr./Brd. C. Fbr. (heavy build)	Good	Fair	Good
			K20-1-355	Standard	Brd. C. Fbr./Brd. C. Fbr.	Good	Fair	Good
			K20-2-350	Special	Brd.C. Fbr./Brd. C. Fbr. (heavy build)	Good	Fair	Good
			N20-2-350	Special	Brd. C Fbr./Brd. C Fbr. (heavy build)	Good	Fair	Good
			K20-2-355	Special	Brd. C. Fbr./Brd. C. Fbr.	Good	Fair	Good
			N-20-2-355	Special	Brd. C. Fbr./Brd. C. Fbr.	Good	Fair	Good
2000	1093	Vitreous Silica	K20-1-301	Standard	Brd. Sil./Brd.Sil. (heavy build)	Fair	Fair	Good
			K20-1-365	Standard	Brd. Sil./Brd.Sil.	Fair	Fair	Good
			K20-2-301	Special	Brd. Sil./Brd. Sil. (heavy build)	Fair	Fair	Good
			N20-2-301	Special	Brd. Sil./Brd. Sil. (heavy build)	Fair	Fair	Good
			K20-2-365	Special	Brd. Sil./Brd.Sil.	Fair	Fair	Good
			N20-2-365	Special	Brd. Sil./Brd. Sil. (heavy build)	Fair	Fair	Good
1652	900	High Temp. Fiberglass	J20-1-314	Standard	Brd. HT Gls./TW	Good	Good	Good
			J20-2-321	Special	Brd. HT Gls./Brd. HT Gls.	Good	Good	Good
			K20-1-321	Standard	Brd. HT Gls./Brd. HT Gls.	Good	Good	Good
			K20-2-314	Special	Brd. HT Gls./TW	Good	Good	Good
			K20-2-321	Special	Brd. HT Gls./Brd. HT Gls.	Good	Good	Good
1000	538	Standard Fiberglass	J20-1-304	Standard	Brd. Gls./Brd. Gls.	Fair	Good	Good
			J20-1-S-304	Standard	Brd. Gls./Brd. Gls.	Fair	Good	Good
			J20-2-304	Special	Brd. Gls./Brd. Gls.	Fair	Good	Good
			J20-3-304	Standard	Brd. Gls./Brd. Gls.	Fair	Good	Good
			J20-3-S-304	Standard	Brd. Gls./Brd. Gls./SS Brd.	Fair	Good	Good
			J24-1-304	Standard	Brd. Gls./Brd. Gls.	Fair	Good	Good
			J24-2-304	Special	Brd. Gls./Brd. Gls.	Fair	Good	Good
			J24-3-304	Standard	Brd. Gls./Brd. Gls.	Fair	Good	Good
			J28-2-305	Special	Wrp. Dbl. Gls./Brd. Gls.	Fair	Good	Good
			J30-1-305	Standard	Wrp. Dbl. Gls./Brd. Gls.	Fair	Good	Good
			J30-2-305	Special	Wrp. Dbl. Gls./Brd. Gls.	Fair	Good	Good
			K20-1-304	Standard	Brd. Gls./Brd. Gls.	Fair	Good	Good
			K20-1-S-304	Standard	Brd. Gls./Brd. Gls.	Fair	Good	Good
			K20-2-304	Special	Brd. Gls./Brd. Gls.	Fair	Good	Good
			K20-3-304	Standard	Brd. Gls./Brd. Gls.	Fair	Good	Good
			K20-3-S-304	Standard	Brd. Gls./Brd. Gls./SS Brd.	Fair	Good	Good
			K24-1-304	Standard	Brd. Gls./Brd. Gls.	Fair	Good	Good
			K24-2-304	Special	Brd. Gls./Brd. Gls.	Fair	Good	Good
			K24-3-304	Standard	Brd. Gls./Brd. Gls.	Fair	Good	Good
			K28-2-305	Special	Wrp. Dbl. Gls./Brd. Gls.	Fair	Good	Good
			K30-1-305	Standard	Wrp. Dbl. Gls./Brd. Gls.	Fair	Good	Good
			K30-2-305	Special	Wrp. Dbl. Gls./Brd. Gls.	Fair	Good	Good
			T20-1-304	Standard	Brd. Gls./Brd. Gls.	Fair	Good	Good

CONTINUED

\*Note: The recommended operating temperature is limited to the extension grade alloy recommended temperature of 400°F (204°C).

# SERV-RITE Wire

## Thermocouple and Extension Wire



### Stock Wire Products by Temperature (Continued)

Thermocouple Wire Max. Opr. Temp.		Insulation	Part Number	Limits of Error	Description	Physical Properties		
°F	°C					Abrasion Resistance	Moisture Resistance	Chemical Resistance
800	427	Polyimide Tape	J20-3-512	Standard	Tp. P-mide/Tp. P-mide	Excellent	Excellent	Excellent
			J24-2-511	Special	Tp. P-mide/TW	Excellent	Excellent	Excellent
			K20-3-512	Standard	Tp. P-mide/Tp. P-mide	Excellent	Excellent	Excellent
600	316	TFE Tape	J20-2-508	Special	Tp. TFE/Tp. TFE	Good	Excellent	Excellent
			J24-2-508	Special	Tp. TFE/Tp. TFE	Good	Excellent	Excellent
			K20-2-508	Special	Tp. TFE/Tp. TFE	Good	Excellent	Excellent
			K24-1-508	Standard	Tp. TFE/Tp. TFE	Good	Excellent	Excellent
			K24-2-508	Special	Tp. TFE/Tp. TFE	Good	Excellent	Excellent
			T20-2-508	Special	Tp. TFE/Tp. TFE	Good	Excellent	Excellent
			T24-1-508	Standard	Tp. TFE/Tp. TFE	Good	Excellent	Excellent
			T24-2-508	Special	Tp. TFE/Tp. TFE	Good	Excellent	Excellent
500	260	FEP	J20-2-507	Special	FEP/FEP	Excellent	Excellent	Excellent
			J20-3-507	Standard	FEP/FEP	Excellent	Excellent	Excellent
			J20-5-509*	Standard	FEP/TWS/FEP	Excellent	Excellent	Excellent
			J24-2-507	Special	FEP/FEP	Excellent	Excellent	Excellent
			J24-3-507	Standard	FEP/FEP	Excellent	Excellent	Excellent
			J30-2-506	Special	FEP/FEP	Excellent	Excellent	Excellent
			K16-5-509*	Standard	FEP/TWS/FEP	Excellent	Excellent	Excellent
			K20-1-507	Standard	FEP/FEP	Excellent	Excellent	Excellent
			K20-2-507	Special	FEP/FEP	Excellent	Excellent	Excellent
			K20-2-509	Special	FEP/TWS/FEP	Excellent	Excellent	Excellent
			K20-3-507	Standard	FEP/FEP	Excellent	Excellent	Excellent
			K20-3-S-507	Standard	FEP/FEP/SSBRD	Excellent	Excellent	Excellent
			K20-5-507*	Standard	FEP/FEP	Excellent	Excellent	Excellent
			K20-5-509*	Standard	FEP/TWS/FEP	Excellent	Excellent	Excellent
			K24-1-507	Standard	FEP/FEP	Excellent	Excellent	Excellent
			K24-2-507	Special	FEP/FEP	Excellent	Excellent	Excellent
			K24-3-507	Standard	FEP/FEP	Excellent	Excellent	Excellent
			K30-2-506	Special	FEP/FEP	Excellent	Excellent	Excellent
			T20-2-507	Special	FEP/FEP	Excellent	Excellent	Excellent
			T20-3-507	Standard	FEP/FEP	Excellent	Excellent	Excellent
T24-2-507	Special	FEP/FEP	Excellent	Excellent	Excellent			
T30-2-506	Special	FEP/FEP	Excellent	Excellent	Excellent			

**CONTINUED**

\*Note: The recommended operating temperature is limited to the extension grade alloy recommended temperature of 400°F (204°C).

# SERV-RITE Wire

## Thermocouple and Extension Wire



### Stock Wire Products by Temperature (Continued)

Thermocouple Wire Max. Opr. Temp.		Insulation	Part Number	Limits of Error	Description	Physical Properties		
°F	°C					Abrasion Resistance	Moisture Resistance	Chemical Resistance
221	105	PVC	J16-5-502*	Standard	PVC/PVC	Good	Excellent	Good
			J16-5-510*	Standard	PVC/TWS/PVC	Good	Excellent	Good
			J20-5-502*	Standard	PVC/PVC	Good	Excellent	Good
			J20-5-510*	Standard	PVC/TWS/PVC	Good	Excellent	Good
			J20-7-502*	Standard	PVC/PVC	Good	Excellent	Good
			J20-7-510*	Standard	PVC/TWS/PVC	Good	Excellent	Good
			J24-2-505	Special	PVC/Ripcord	Good	Excellent	Good
			K16-5-502*	Standard	PVC/PVC	Good	Excellent	Good
			K16-5-510*	Standard	PVC/TWS/PVC	Good	Excellent	Good
			K20-5-502*	Standard	PVC/PVC	Good	Excellent	Good
			K20-5-510*	Standard	PVC/TWS/PVC	Good	Excellent	Good
			K20-7-502*	Standard	PVC/PVC	Good	Excellent	Good
			K20-7-510*	Standard	PVC/TWS/PVC	Good	Excellent	Good
			K24-1-505	Standard	PVC/Ripcord	Good	Excellent	Good
			K24-2-505	Special	PVC/Ripcord	Good	Excellent	Good
			S20-5-502*	Standard	PVC/PVC	Good	Excellent	Good
			T20-5-502*	Standard	PVC/PVC	Good	Excellent	Good
			T20-5-510*	Standard	PVC/TWS/PVC	Good	Excellent	Good
			T20-7-502*	Standard	PVC/PVC	Good	Excellent	Good
			T24-1-505	Standard	PVC/Ripcord	Good	Excellent	Good
T24-2-505	Special	PVC/Ripcord	Good	Excellent	Good			
<b>RTD Lead Wire</b>								
1000	538	Standard Fiberglass	RT3-24-8-705	N/A	Brd. Gls./TW/Brd. Gls.	Fair	Good	Good
500	260	FEP	RT3-22-8-704	N/A	FEP/TW/FEP	Excellent	Excellent	Excellent
221	105	PVC	RT3-22-4-701	N/A	PVC/TW/PVC	Good	Excellent	Good

**\*Note:** The recommended operating temperature is limited to the extension grade alloy recommended temperature of 400°F (204°C).

# SERV-RITE Wire

## Thermocouple and Extension Wire



### Heat Treat Thermocouple Wire

Thermocouple Wire Max. Opr. Temp.		Insulation	Part Number	Limits of Error	Description	Physical Properties		
°F	°C					Abrasion Resistance	Moisture Resistance	Chemical Resistance
1800	982	High Temp. Fiberglass	K20-2-321-CAL	Special	Brd. HT Gls./Brd. HT Gls. Calculated from 200-1800°F (93-982°C), every 200°F (93°C)	Good	Good	Good
2200	1204	Vitreous Silica	K20-2-301-CAL	Special	Brd. Vit. Sil./Brd. Sil. Calculated from 200-2200°F (93-1204°C), every 200°F (93°C)	Fair	Fair	Good
2200	1204	Ceramic	K20-2-350-CAL	Special	Brd. C. Fbr./Brd. C. Fbr. from 200-2200°F (93-1204°C), every 200°F (93°C)	Good	Fair	Good

#### Legend

- |                             |                        |
|-----------------------------|------------------------|
| Brd. = Braided              | Dbl. = Double          |
| Gls. = Fiberglass           | Cot. = Cotton          |
| TWS. = Twisted and shielded | C.Fbr = Ceramic fiber  |
| HT = High temperature       | Sil. = Vitreous silica |
| Tp. = Taped                 | Pr. = Pair             |
| P-mide = Polyimide          | Std. = Standard        |
| Cbl. = Cable                | Spc. = Special         |
| TW. = Twisted               |                        |
| Wrp. = Wrapped              |                        |

## Thermocouple and Extension Wire

### Ordering Information

#### How to Order

Include the following information when ordering SERV-RITE thermocouple and extension wire:

#### Calibration

- E, J, K, N, S or T

#### Gauge size

- AWG gauge

#### Solid or stranded conductors

- Stranded conductors are seven strand constructions. If other configurations are required, please contact the factory.

#### Thermocouple or extension grade

- Determine if it will be used for the actual sensor or only to “extend” the signal at lower temperatures.

#### Standard or special limits of error

- This will determine the accuracy of the sensor. Limits of error are determined by testing at a pre-defined Watlow standard test point. To guarantee limits of error at other temperature points, please contact the factory to arrange special testing.

#### Insulation on singles and duplex

- The insulation material used is usually chosen to fit the environment where the sensor will be used.

#### Color coding

- Unless specified, all color coding is to ASTM E 230 standards.

#### Spool lengths

- Spool length requirements should be specified. Watlow strives to maintain a policy of shipping 1,000 foot spools. However, if not specified, random lengths may be shipped. If special packaging is required, please contact the factory.

#### Variation in quantity

- Watlow follows the industry standard of shipping and invoicing at plus or minus 10 percent of the cost for any ordered item. If requirements dictate anything other than plus or minus ten percent, contact the factory for potential additional charges.

#### Overbraid options

- Options for overbraid are shown below.

#### Overbraid selection code

- S—Stainless steel wire braid  
C—Tinned copper wire braid  
N—Alloy 600 wire braid

Options are listed on each page. Special requirements and testing are available at additional cost. Contact the factory for details. These include:

#### Shielding

- Some constructions are available with shielding possibilities.

#### Calibration Tests

- If calibration is required, please specify temperatures.

#### Certificate of Compliance

- These may be provided for various specifications. When ordering, please provide specification requirements.

#### Special Requirements

- Please contact the factory for any requirements not listed above.

#### Availability

**Stock constructions:** Many constructions are available for same day shipment.

**Stock constructions with options:** Shipment is usually within five working days or less.

**Stock constructions requiring calibration or other laboratory services:** Shipment is usually within five working days or less.

## Thermocouple and Extension Wire

### Technical Data

#### How to Select Wire to Meet Requirements

The following information will explain some of the nomenclature associated with thermocouple wire and thermocouple extension wire. By reading this information, orders can be placed quickly and accurately.

#### Thermocouple Wire or Thermocouple Extension Wire

There are some significant differences between wire used to actually measure temperature and wire used to carry a millivoltage signal to an instrument.

The most obvious difference is the color-code used to identify the wire itself. In most instances, thermocouple grade wire is identified by its overall brown color. Exceptions in the SERV-RITE wire product line are the very high temperature yarns such as those used in the SERIES 301 and 350. Of course, the overall color code is not used if there is no overall covering, as in SERV-RITE wire SERIES 505, 511 and 314.

The functional differences between the two wires are that thermocouple “extension” wire is not calibrated above 400°F (204°C). The temperature rating of the insulations used on some extension grade wire exceeds 400°F (204°C) temperature to allow the wire to survive occasional contact with hot parts or furnace walls.

Terms used in the tables of this section:

#### Single Conductor Insulation

Identifies insulation type used on individual thermoelements. Certain part numbers use a combination of insulations. When there is a combination, insulations are listed in order of application.

#### Duplex Conductor Insulation

Lists the overall insulation when one is used. Constructions which have no overall insulation use this area to describe the duplexing method—i.e. twisting, “ripcord,” etc.

#### Temperature Rating

Most constructions are rated for both continuous use and for single reading applications. Continuous use temperature is considered to be the highest temperature a particular construction will survive indefinitely. The single reading temperature is the highest temperature at which the construction will perform and continue to produce an accurate reading. However, after exposure to the single reading temperature, the wire will exhibit less flexibility and/or abrasion resistance. Therefore, it is not likely that the wire could be removed from the application and then reused.

#### ASTM E 230 Color Code

Generally, SERV-RITE wire has color codes wherever possible. Exceptions are high temperature yarn constructions such as the SERIES 301 and 350. Color coding of the SERIES 511 and 512 is accomplished by including a colored thread or “tracer” under the tape.

#### Physical Properties

**Abrasion Resistance** is rated fair, good, or excellent and is based on the wall thickness of the construction and how well it survives with other insulations of similar thicknesses. The 511 SERIES receives an excellent rating because the thin wall of polyimide tape will survive better than almost any other insulation applied in the same wall thickness. The “absolute” abrasion resistance of a construction will depend not only on the type of insulation, but on thickness at which it is applied.

**Moisture Resistance** ratings are given for wire in the “as received” condition. In the case of fiberglass insulated wire, moisture resistance is achieved by using impregnations or spirally applied tapes called moisture barriers. The impregnations and/or tapes will burn off at temperatures below the upper useful operating temperatures of the fiberglass. The thermoplastic insulations (PVC and fluoroplastics) and polyimide insulated constructions will maintain their moisture resistance up to their “continuous” temperature rating.

**Chemical Resistance** ratings are applied as they relate to most common chemicals. These ratings apply to insulation types and not necessarily to the type of impregnation used. Contact the factory for specific applications.

# SERV-RITE Wire

## Thermocouple and Extension Wire

### Technical Data (Continued)

#### Metallic Overbraids and Wraps

Although standard SERV-RITE wire products are designed to yield a high degree of abrasion resistance, it is sometimes necessary to add an additional metallic covering to further enhance this property. Following are available overbraids and wraps.

#### Stainless Steel Wire Braid (S)

This most popular over-braid uses 300 series stainless steel and is available on virtually all standard SERV-RITE wire offerings. It is an economical method to extend the life of thermocouple and extension wire. Several of Watlow's standard wire items are available from stock with a stainless overbraid. Non-stock items are available as a special order.

#### Alloy 600 Wire Braid (N)

Most commonly specified on high temperature SERV-RITE wire yarn insulations, the Inconel® braid offers a higher operating temperature than the series 300 stainless steel overbraid. When this braid is specified on SERV-RITE SERIES 350, the performance of the material is only surpassed by metal-sheathed cables. Consult the factory for availability on specific wire items.

#### Tinned Copper Wire Overbraid (C)

When there is a possibility of electrical interference in the area of the thermocouple installation, it may be necessary to shield the wire from electrical "noise." Several Watlow standard products use aluminized tapes as an intrinsic shield. If shielding is needed on other constructions, a tinned copper shield can be specified as a special order.

## Ordering Information

**Example Part Number** - Typical code number J20/1/304 becomes J20/1/S/304

① ANSI Letter Designation	② ③ B & S Gauge	④ Conductor Type/Tolerance	⑤ Metallic Overbraid/ Wrap Type	⑥ ⑦ ⑧ Insulation Type
J	20	1	S	304

① ANSI Letter Designation (Calibration)
J = Type J

② ③ B & S Gauge
20 = 20 gauge solid

④ Conductor Type/Tolerance
1 = Thermocouple grade, solid wire, standard tolerance
2 = Thermocouple grade, solid wire, special tolerance
3 = Thermocouple grade, stranded wire, standard tolerance
4 = Thermocouple grade, stranded wire, special tolerance
5 = Extension grade, solid wire, standard tolerance
6 = Extension grade, solid wire, special tolerance
7 = Extension grade, stranded wire, standard tolerance
8 = Extension grade, stranded wire, special tolerance

⑤ Metallic Overbraid/ Wrap Type
S = Stainless steel
N = Alloy 600
C = Tinned copper

⑥ ⑦ ⑧ Insulation Type
304 = Type 304 SS



# SERV-RITE Wire

## Thermocouple and Extension Wire

### High-Temperature Vitreous Silica Braided Thermocouple Wire SERIES 301 and 365

Both the SERIES 301 and 365 use vitreous silica yarn as the insulation on both the conductors and duplex. This yarn retains its flexibility after exposure to high temperatures. Because this insulation has no binders or impregnations, it may “flower” when stripped.

The vitreous silica yarn’s greater purity performs better at high temperatures than other fibrous glass products. Testing indicates that “contamination” will compromise this material’s upper use temperature. The SERIES 365 construction is a cost-effective, medium insulation build of the popular heavy duty SERIES 301 construction.

For higher temperatures consider SERIES 350.

#### Performance Capabilities

- Continuous temperature rating: 1800°F (982°C)
- Vitreous silica braided yarn insulation
- Available with an optional metallic overbraid for additional abrasion resistance



#### Applications

- Heat treating
- Oven and furnace
- Survey and load

#### Specifications

##### Continuous use temperature

- 1800°F (980°C)

##### Single use temperature

- 2000°F (1093°C)

##### Resistance properties

- Moisture: Fair
- Chemical: Good
- Abrasion: Fair

### Popular Constructions

Grade	AWG	Wire Type	Insulation	Limits of Error	Type K
Thermocouple	20	Solid	Heavy	Standard	<b>K20-1-301</b>
		Solid	Heavy	Special	<b>K20-2-301</b>
		Solid	Heavy	Standard	<b>N20-1-301</b>
		Solid	Heavy	Special	<b>N20-2-301</b>
		Solid	Heavy	Special	<b>K20-2-301-CAL*</b>
		Solid	Medium	Standard	<b>K20-1-365</b>
		Solid	Medium	Special	<b>K20-2-365</b>
		Solid	Medium	Standard	<b>N20-1-365</b>
		Solid	Medium	Special	<b>N20-2-365</b>

\* Calibrated from 200 to 2200°F (93 to 1204°C), every 200°F (93°C). Only available in this construction.

**Note:** Bolded products are stocked.

### Wire Specifications

AWG	Nominal Conductor Size in. (mm)	Nominal Insulation Thickness		Nominal Overall Size in. (mm)	Approximate Shipping Weight lbs/1000 ft (kg/km)
		Conductor in. (mm)	Overall in. (mm)		
20 <sup>①</sup>	0.032 (0.813)	0.018 (0.457)	0.015 (0.381)	0.098 x 0.154 (2.49 x 3.91)	15 (22.4)
18 <sup>①</sup>	0.040 (1.020)	0.018 (0.457)	0.015 (0.381)	0.110 x 0.180 (2.79 x 4.57)	19 (28.3)
16 <sup>①</sup>	0.051 (1.290)	0.016 (0.406)	0.015 (0.381)	0.118 x 0.198 (3.00 x 5.03)	25 (37.3)
20 <sup>②</sup>	0.032 (0.813)	0.015 (0.381)	0.012 (0.305)	0.090 x 0.140 (2.29 x 3.56)	13 (19.4)

<sup>①</sup>SERIES 301, <sup>②</sup>SERIES 365

### Ordering Information

#### Part Number

① ASTM E 230 Calibration	② ③ AWG	④ Conductor Type/ Tolerance	⑤ ⑥ ⑦ Insulation Type

①	ASTM E 230 Calibration
K =	Type K
N =	Type N

② ③	AWG
20 =	20 gauge solid

**Note:** Minimum order sizes apply for non-stock constructions.

④	Conductor/Type Tolerance
1 =	Thermocouple grade, solid wire, standard tolerance
2 =	Thermocouple grade, solid wire, special tolerance

⑤ ⑥ ⑦	Insulation Type
301 =	Heavy build
365 =	Medium build

# SERV-RITE Wire

## Thermocouple and Extension Wire

### Fiberglass Braided Thermocouple and Extension Wire SERIES 304

The uniform quality and availability of the SERIES 304 make it the ideal wire for general applications requiring moderate abrasion and moisture resistance, wide temperature capabilities and economy.

Each conductor is covered with a color coded glass braid. This braid is impregnated to enhance abrasion resistance and reduce fraying. The insulated single conductors are laid parallel and covered with another layer of woven glass. A final impregnation is then applied to the glass.

For higher temperatures, consider SERIES 321.

#### Performance Capabilities

- Continuous temperature rating: 900°F (482°C)
- Fiberglass braided yarn insulation
- Available with an optional metallic overbraid for additional abrasion resistance



#### Applications

- Heat treating
- Oven
- General use

#### Specifications

##### Continuous use temperature

- 900°F (482°C)

##### Single use temperature

- 1000°F (540°C)

##### Resin retained to 400°F (204°C)

##### Resistance properties

- Moisture: Good
- Chemical: Good
- Abrasion: Fair

## Popular Constructions

Grade	AWG	Wire Type	Limits of Error	Type K	Type J	Type T	Type E
Thermocouple	20	Solid	Standard	<b>K20-1-304*</b>	<b>J20-1-304*</b>	<b>T20-1-304</b>	<b>E20-1-304</b>
		Solid	Special	<b>K20-2-304</b>	<b>J20-2-304</b>	T20-2-304	E20-2-304
		Stranded	Standard	<b>K20-3-304*</b>	<b>J20-3-304*</b>	T20-3-304	E20-3-304
	24	Solid	Standard	<b>K24-1-304</b>	<b>J24-1-304</b>	<b>T24-1-304</b>	
		Solid	Special	<b>K24-2-304</b>	<b>J24-2-304</b>	T24-2-304	
		Stranded	Standard	<b>K24-3-304</b>	<b>J24-3-304</b>		
Extension	20	Solid	Standard				

\* These constructions stocked with a **stainless steel overbraid** (order overbraid by adding "-S" in front of construction type (i.e. K20-1-S-304).

**Note:** **Bolded** products are stocked.

## Wire Specifications

AWG	Nominal Conductor Size in. (mm)		Nominal Insulation Thickness		Nominal Overall Size in. (mm)		Approximate Shipping Weight lbs/1000 ft (kg/km)	
			Conductor in. (mm)	Overall in. (mm)				
24	0.020	(1.508)	0.005 (0.127)	0.006 (0.152)	0.045 x 0.072	(1.14 x 1.83)	7	(10.4)
24 S* (7/32)	0.024	(1.610)	0.005 (0.127)	0.006 (0.152)	0.048 x 0.080	(1.22 x 2.03)	8	(11.9)
20	0.032	(1.813)	0.005 (0.127)	0.006 (0.152)	0.056 x 0.096	(1.42 x 2.44)	9	(13.4)
20 S* (7/28)	0.038	(1.965)	0.006 (0.152)	0.006 (0.152)	0.064 x 0.112	(1.63 x 2.84)	10	(14.9)

\* "S" denotes stranded wire: e.g., "20 S (7/28)" is seven strands of 28 gauge wire to make a 20 gauge stranded conductor.

# SERV-RITE Wire

## Thermocouple and Extension Wire

*Fiberglass Braided Thermocouple and Extension Wire SERIES 304 (Continued)*

### Ordering Information

Part Number

① ASTM E 230 Calibration	② ③ AWG	④ Conductor Type/ Tolerance	⑤	⑥	⑦
			3	0	4

①	ASTM E 230 Calibration
E =	Type E
J =	Type J
K =	Type K
S =	Type S
T =	Type T

② ③	AWG
24 =	24 gauge solid or 24 gauge stranded (7/32)
20 =	20 gauge solid or 20 gauge stranded (7/28)

④	Conductor Type/Tolerance
1 =	Thermocouple grade, solid wire, standard tolerance
2 =	Thermocouple grade, solid wire, special tolerance
3 =	Thermocouple grade, stranded wire, standard tolerance
4 =	Thermocouple grade, stranded wire, special tolerance
5 =	Extension grade, solid wire, standard tolerance
6 =	Extension grade, solid wire, special tolerance
7 =	Extension grade, stranded wire, standard tolerance
8 =	Extension grade, stranded wire, special tolerance

**Note:** Minimum order sizes apply for non-stock constructions.

# SERV-RITE Wire

## Thermocouple and Extension Wire

### Fiberglass Wrapped Thermocouple and Extension Wire SERIES 305

SERIES 305 is specifically constructed for light duty applications where size is a critical factor. Single conductors are insulated using a specialized yarn wrapped around the conductors in layers. Yarn is then impregnated to add abrasion resistance and enhance electrical properties. The insulated single conductors are then laid parallel and covered with a layer of braided glass. A final impregnation is applied to the braid.

For higher temperature applications, use SERIES 321.

#### Performance Capabilities

- Continuous temperature rating: 900°F (482°C)
- Fiberglass braided yarn insulation
- Yarn wrapped conductors for superior coverage on small gauge wires
- Available with an optional metallic overbraid for additional abrasion resistance



#### Applications

- Heat treating
- Oven
- General use

#### Specifications

##### Continuous use temperature

- 900°F (482°C)

##### Single use temperature

- 1000°F (540°C)

##### Resin retained to 400°F (204°C)

##### Resistance properties

- Moisture: Good
- Chemical: Good
- Abrasion: Fair

## Popular Constructions

Grade	AWG	Wire Type	Limits of Error	Type K	Type J
Thermocouple	24	Solid	Standard	K24-1-305	J24-1-305
		Solid	Special	K24-2-305	J24-2-305
	28	Solid	Standard	K28-1-305	J28-1-305
		Solid	Special	<b>K28-2-305</b>	<b>J28-2-305</b>
	30	Solid	Standard	<b>K30-1-305</b>	<b>J30-1-305</b>
		Solid	Special	<b>K30-2-305</b>	<b>J30-2-305</b>

**Note:** Bolded products are stocked.

## Wire Specifications

AWG	Nominal Conductor Size in. (mm)		Nominal Insulation Thickness				Nominal Overall Size in. (mm)		Approximate Shipping Weight lbs/1000 ft (kg/km)	
			Conductor in. (mm)		Overall in. (mm)					
30	0.010	(0.254)	0.005	(0.127)	0.008	(0.203)	0.036 x 0.056	(0.914 x 1.42)	3	(4.5)
28	0.013	(0.320)	0.005	(0.127)	0.008	(0.203)	0.040 x 0.062	(1.02 x 1.57)	3	(4.5)
24	0.020	(0.508)	0.005	(0.127)	0.006	(0.152)	0.042 x 0.072	(1.07 x 1.83)	7	(10.4)
24 S* (7/32)	0.024	(0.610)	0.005	(0.127)	0.006	(0.152)	0.048 x 0.080	(1.22 x 2.03)	8	(11.9)
20	0.032	(0.813)	0.005	(0.127)	0.006	(0.152)	0.054 x 0.096	(1.37 x 2.44)	9	(13.4)
20 S* (7/28)	0.038	(0.965)	0.005	(0.127)	0.006	(0.152)	0.060 x 0.108	(1.52 x 2.74)	10	(14.9)

\* "S" denotes stranded wire: e.g., "24 S (7/32)" is seven strands of 32 gauge wire to make a 24 gauge stranded conductor.

# SERV-RITE Wire

## Thermocouple and Extension Wire

*Fiberglass Wrapped Thermocouple and Extension Wire SERIES 305 (Continued)*

### Ordering Information

#### Part Number

①	② ③	④	⑤	⑥	⑦
ASTM E 230 Calibration	AWG	Conductor Type/Tolerance			
			3	0	5

①	ASTM E 230 Calibration
E =	Type E
J =	Type J
K =	Type K
S =	Type S
T =	Type T

② ③	AWG
30 =	30 gauge solid
28 =	28 gauge solid
24 =	24 gauge solid or 24 gauge stranded (7/32)
20 =	20 gauge solid or 20 gauge stranded (7/28)

④	Conductor Type/Tolerance
1 =	Thermocouple grade, solid wire, standard tolerance
2 =	Thermocouple grade, solid wire, special tolerance
3 =	Thermocouple grade, stranded wire, standard tolerance
4 =	Thermocouple grade, stranded wire, special tolerance
5 =	Extension grade, solid wire, standard tolerance
6 =	Extension grade, solid wire, special tolerance
7 =	Extension grade, stranded wire, standard tolerance
8 =	Extension grade, stranded wire, special tolerance

**Note:** Minimum order sizes apply for non-stock constructions.

# SERV-RITE Wire

## Thermocouple and Extension Wire

### High-Temperature Fiberglass Twisted Thermocouple Wire SERIES 314

The SERIES 314 is an economical construction for general, high temperature applications. The braided high temperature yarn is applied in a unique manner that allows SERIES 314 to be competitively priced with other fiberglass constructions. It produces a finished wire that performs at temperatures to 1600°F (870°C).

The conductors are insulated with braided, high strength fiberglass and impregnated to improve abrasion resistance. The impregnation is tinted to impart color coding to primary insulations. The insulated single conductors are then twisted together to yield a construction flexible enough for almost any application.

#### Performance Capabilities

- Continuous temperature rating: 1300°F (705°C)
- Fiberglass braided yarn insulation
- Twisted design has no jacket
- Available with an optional metallic overbraid for additional abrasion resistance



#### Applications

- Heat treating
- Aluminum stress relieving
- Steel annealing

#### Specifications

##### Continuous use temperature

- 1300°F (705°C)

##### Single use temperature

- 1600°F (870°C)

##### Resin retained to 400°F (204°C)

##### Resistance properties

- Moisture: Good
- Chemical: Good
- Abrasion: Good

### Popular Constructions

Grade	AWG	Wire Type	Limits of Error	Type K	Type J
Thermocouple	20	Solid	Standard	K20-1-314	J20-1-314
		Solid	Special	<b>K20-2-314</b>	<b>J20-2-314</b>
	24	Solid	Standard	K24-1-314	J24-1-314
		Solid	Special	K24-2-314	J24-2-314

**Note:** Bolded products are stocked.

### Wire Specifications

AWG	Nominal Conductor Size		Nominal Conductor Insulation Thickness		Nominal Overall Size		Approximate Shipping Weight	
	in.	(mm)	in.	(mm)	in.	(mm)	lbs/1000 ft	(kg/km)
24	0.020	(0.508)	0.015	(0.381)	0.100	(2.54)	6	(8.9)
20	0.032	(0.965)	0.015	(0.381)	0.124	(3.15)	10	(14.9)
18	0.040	(1.02)	0.018	(0.457)	0.152	(3.56)	16	(23.8)
16	0.051	(1.29)	0.018	(0.457)	0.174	(4.42)	21	(31.3)

### Ordering Information

#### Part Number

①	② ③	④	⑤	⑥	⑦
ASTM E 230 Calibration	AWG	Conductor Type/Tolerance			
			<b>3</b>	<b>1</b>	<b>4</b>

①	ASTM E 230 Calibration
J	= Type J
K	= Type K

② ③	AWG
24	= 24 gauge solid
20	= 20 gauge solid
16	= 16 gauge solid

④	Conductor Type/Tolerance
1	= Thermocouple grade, solid wire, standard tolerance
2	= Thermocouple grade, solid wire, special tolerance

**Note:** Minimum order sizes apply for non-stock constructions.

# SERV-RITE Wire

## Thermocouple and Extension Wire

### High-Temperature Braided Fiberglass Thermocouple Wire SERIES 321

The addition of color coding and impregnation to the high temperature fiberglass make this wire the next logical step for systems which exceed temperature capabilities of the standard glass insulated series.

Each conductor is covered with a color coded, high temperature fiberglass braid. This braid is then impregnated to enhance abrasion resistance and reduce fraying. The insulated conductors are laid parallel and covered with another braid of high temperature fiberglass and impregnation.

#### Performance Capabilities

- Continuous temperature rating: 1300°F (705°C)
- Heavy fiberglass braided yarn insulation
- Twisted design has no jacket
- Available with an optional metallic overbraid for additional abrasion resistance



#### Applications

- Heat treating
- Aluminum and steel

#### Specifications

##### Continuous use temperature

- 1300°F (705°C)

##### Single use temperature

- 1600°F (870°C)

##### Resin retained to 400°F (204°C)

##### Resistance properties

- Moisture: Good
- Chemical: Good
- Abrasion: Good

## Popular Constructions

Grade	AWG	Wire Type	Limits of Error	Type K	Type J
Thermocouple	20	Solid	Standard	<b>K20-1-321</b>	<b>J20-1-321</b>
		Solid	Special	<b>K20-2-321</b>	<b>J20-2-321</b>
		Solid	Special		<b>J20-2-321-CAL*</b>
	24	Solid	Standard	K24-1-321	J24-1-321
		Solid	Special	K24-2-321	J24-2-321

\* Calibrated from 200 to 2200°F (93 to 1204°C), every 200°F (93°C). Only available in this construction.

**Bolded** products are stocked.

## Wire Specifications

AWG	Nominal Conductor Size in. (mm)		Nominal Insulation Thickness		Nominal Overall Size in. (mm)		Approximate Shipping Weight lbs/1000 ft (kg/km)	
			Conductor in. (mm)	Overall in. (mm)				
24	0.020	(0.508)	0.015 (0.381)	0.010 (0.254)	0.072 x 0.120	(1.83 x 3.05)	10	(14.9)
20	0.032	(0.965)	0.015 (0.381)	0.010 (0.254)	0.082 x 0.140	(2.08 x 3.56)	13	(19.4)
18	0.040	(1.02)	0.015 (0.381)	0.010 (0.254)	0.090 x 0.156	(2.29 x 3.96)	18	(26.8)

## Ordering Information

### Part Number

① ASTM E 230 Calibration	② ③ AWG	④ Conductor Type/ Tolerance	⑤	⑥	⑦
			<b>3</b>	<b>2</b>	<b>1</b>

①	ASTM E 230 Calibration
J =	Type J
K =	Type K

② ③	AWG
24 =	24 gauge solid
20 =	20 gauge solid

④	Conductor Type/Tolerance
1 =	Thermocouple grade, solid wire, standard tolerance
2 =	Thermocouple grade, solid wire, special tolerance

**Note:** Minimum order sizes apply for non-stock constructions.

# SERV-RITE Wire

## Thermocouple and Extension Wire

### High-Temperature Ceramic Fiber Thermocouple Wire SERIES 350 and 355

The SERIES 350 uses the ultimate high-temperature flexible insulating system. The ceramic fiber yarn's upper temperature limit often exceeds the melting point of the material it insulates.

When an application requires flexible insulation, while pushing Type K or Type N to extreme limits, ceramic fiber insulation is the only choice.

Watlow supplies standard SERIES 350 without color coding or impregnations to minimize contaminating the pure ceramic fiber yarn. Because this insulation has no binders or impregnations, it may "flower" when stripped. Laboratory testing indicates impregnation can decrease the upper use temperature by as much as 1000°F (540°C).

The SERIES 355 construction is a cost-effective, medium insulation build of the popular SERIES 350 heavy-duty construction.

If application temperatures exceed SERIES 350 construction, specify XACTPAK® mineral-insulated, metal-sheathed cable.

### Performance Capabilities

- Continuous temperature rating: 1205°C (2200°F)
- Ceramic fiber braided yarn insulation
- Available with an optional metallic overbraid for additional abrasion resistance

### Popular Constructions

Grade	AWG	Wire Type	Insulation	Limits of Error	Type K
Thermocouple	20	Solid	Heavy	Standard	<b>K20-1-350</b>
		Solid	Heavy	Special	<b>K20-2-350</b>
		Solid	Heavy	Standard	<b>N20-1-350</b>
		Solid	Heavy	Special	<b>N20-2-350</b>
		Solid	Heavy	Special	<b>K20-2-350-CAL*</b>
		Solid	Medium	Standard	<b>K20-1-355</b>
		Solid	Medium	Special	<b>K20-2-355</b>
		Solid	Medium	Standard	<b>N20-1-355</b>
		Solid	Medium	Special	<b>N20-2-355</b>

\* Calibrated from 200 to 2200°F (93 to 1204°C), every 200°F (93°C). Only available in this construction.

**Bolded** products are stocked.

### Wire Specifications

AWG	Nominal Conductor Size in. (mm)		Nominal Insulation Thickness		Nominal Overall Size in. (mm)		Approximate Shipping Weight lbs/1000 ft (kg/km)	
			Conductor in. (mm)	Overall in. (mm)				
24 <sup>①</sup>	0.020	(0.508)	0.016 (0.406)	0.016 (0.406)	0.088 x 0.132	(2.24 x 3.35)	13	(19.4)
20 <sup>①</sup>	0.032	(0.965)	0.016 (0.406)	0.016 (0.406)	0.100 x 0.154	(2.54 x 3.91)	16	(23.8)
16 <sup>①</sup>	0.051	(1.29)	0.016 (0.406)	0.016 (0.406)	0.119 x 0.192	(3.02 x 4.88)	32	(47.7)
14 <sup>①</sup>	0.064	(1.63)	0.016 (0.406)	0.016 (0.406)	0.132 x 0.218	(3.35 x 5.54)	44	(65.6)
24 <sup>②</sup>	0.020	(0.508)	0.012 (0.305)	0.016 (0.406)	0.078 x 0.116	(1.98 x 2.95)	13	(19.4)
20 <sup>②</sup>	0.032	(0.813)	0.012 (0.305)	0.016 (0.406)	0.090 x 0.138	(2.29 x 3.50)	16	(23.8)
16 <sup>②</sup>	0.051	(1.29)	0.012 (0.305)	0.016 (0.406)	0.111 x 0.176	(2.82 x 4.47)	32	(47.7)

①SERIES 350, ②SERIES 355

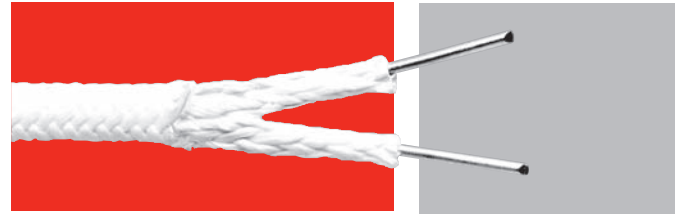

### Applications

- Heat treating
- Oven and furnace survey
- Load thermocouple

### Specifications

#### Continuous use temperature

- 2200°F (1205°C)

#### Single use temperature

- 2600°F (1430°C)

#### Resistance properties

- Moisture: Fair
- Chemical: Good
- Abrasion: Good



# SERV-RITE Wire

## Thermocouple and Extension Wire

High-Temperature Ceramic Fiber  
 Thermocouple Wire SERIES 350 and 355 (Continued)

### Ordering Information

Part Number

① ASTM E 230 Calibration	② ③ AWG	④ Conductor Type/ Tolerance	⑤ ⑥ ⑦ Insulation Type

①	ASTM E 230 Calibration
K =	Type K
N =	Type N

② ③	AWG
24 =	20 gauge solid
20 =	20 gauge solid
16 =	16 gauge solid
14 =	14 gauge solid

④	Conductor/Type Tolerance
1 =	Thermocouple grade, solid wire, standard tolerance
2 =	Thermocouple grade, solid wire, special tolerance

⑤ ⑥ ⑦	Insulation Type
350=	Heavy build
355=	Medium build

**Note:** Minimum order sizes apply for non-stock constructions.

# SERV-RITE Wire

## Thermocouple and Extension Wire

### Polyvinyl Chloride (PVC) Insulated Extension Wire SERIES 502

SERIES 502 is an economical wire that has PVC for the primary and duplex insulation.

The primary and duplex insulation is PVC. It yields a construction that is inexpensive and performs continuously at temperatures up to 220°F (105°C).

SERIES 502 is often used in conduit and wiring trays where its flexibility allows for easy installation. It can be easily stripped using hand tools or mechanical methods.

#### Performance Capabilities

- Continuous temperature rating: 220°F (105°C)
- Flexible PVC plastic insulation
- Available with an optional metallic overbraid for additional abrasion resistance

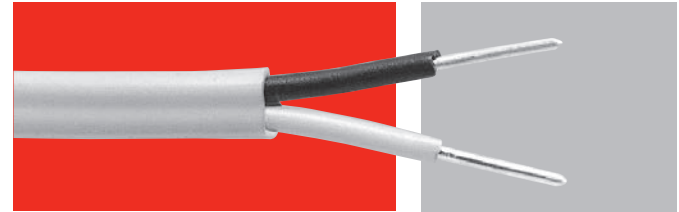

#### Applications

- General use extension wire

#### Specifications

##### Continuous use temperature

- 220°F (105°C)

##### Single use temperature

- 220°F (105°C)

##### Resistance properties

- Moisture: Excellent
- Chemical: Excellent
- Abrasion: Excellent

## Popular Constructions

Grade	AWG	Wire Type	Limits of Error	Type K	Type J	Type T	Type E	Type S
Extension	16	Solid	Standard	<b>K16-5-502</b>	<b>J16-5-502</b>			
		Stranded	Standard	K16-7-502	J16-7-502			
	20	Solid	Standard	<b>K20-5-502</b>	<b>J20-5-502</b>	<b>T20-5-502</b>	<b>E20-5-502</b>	<b>S20-5-502</b>
		Stranded	Standard	<b>K20-7-502</b>	<b>J20-7-502</b>	<b>T20-7-502</b>		
	24	Solid	Standard	K24-5-502	J24-5-502	T24-5-502		
		Stranded	Standard	K24-7-502	J24-7-502	T24-7-502		

Note: **Bolded** products are stocked.

## Wire Specifications

AWG	Nominal Conductor Size in. (mm)	Nominal Insulation Thickness		Nominal Overall Size in. (mm)		Approximate Shipping Weight lbs/1000 ft (kg/km)	
		Conductor in. (mm)	Overall in. (mm)				
24	0.020 (0.508)	0.015 (0.381)	0.015 (0.381)	0.080 x 0.130 (2.03 x 3.30)		10	(14.9)
24 S* (7/32)	0.024 (0.610)	0.015 (0.381)	0.015 (0.381)	0.084 x 0.138 (2.13 x 3.51)		11	(16.4)
20	0.032 (0.813)	0.015 (0.381)	0.015 (0.381)	0.092 x 0.154 (2.34 x 3.91)		14	(20.9)
20 S* (7/28)	0.038 (0.965)	0.015 (0.381)	0.015 (0.381)	0.098 x 0.166 (2.49 x 4.22)		16	(23.8)
16	0.051 (1.29)	0.020 (0.508)	0.020 (0.508)	0.131 x 0.222 (3.33 x 5.64)		28	(41.7)
16 S* (7/24)	0.060 (1.52)	0.020 (0.508)	0.020 (0.508)	0.140 x 0.240 (3.56 x 6.10)		30	(44.7)

\* "S" denotes stranded wire; e.g., "24 S (7/32)" is seven strands of 32 gauge wire to make a 24 gauge stranded conductor.

# SERV-RITE Wire

## Thermocouple and Extension Wire

### PVC Insulated Extension Wire SERIES 502 (Continued)

#### Ordering Information

##### Part Number

① ASTM E 230 Calibration	② ③ AWG	④ Conductor Type/ Tolerance	⑤	⑥	⑦
			5	0	2

①	ASTM E 230 Calibration
E =	Type E
J =	Type J
K =	Type K
S =	Type S
T =	Type T

② ③	AWG
24 =	24 gauge solid or 24 gauge stranded (7/28)
20 =	20 gauge solid or 20 gauge stranded (7/28)
16 =	16 gauge solid or 16 gauge stranded (7/24)

④	Conductor Type/Tolerance
5 =	Extension grade, solid wire, standard tolerance
6 =	Extension grade, solid wire, special tolerance
7 =	Extension grade, stranded wire, standard tolerance
8 =	Extension grade, stranded wire, special tolerance

**Note:** Minimum order sizes apply for non-stock constructions.

# SERV-RITE Wire

## Thermocouple and Extension Wire PVC Insulated "RIPCORDER" SERIES 505

The SERIES 505 is the most economical wire produced. Unlike some competitive "rip-cord" type constructions which use only a stripe to establish polarity, SERIES 505 single conductors are fully color coded. The conductors are individually insulated with the proper colored PVC and fused into "rip-cord" using a proprietary process.

Insulated conductors can be easily separated by hand once the bond between conductors has been slit. As with other PVC insulated products, SERIES 505 lends itself well to both manual and mechanical stripping methods.

### Performance Capabilities

- Continuous temperature rating: 220°F (105°C)
- Flexible PVC plastic insulation
- "Rip-cord" peelable construction
- Available with an optional metallic overbraid for additional abrasion resistance

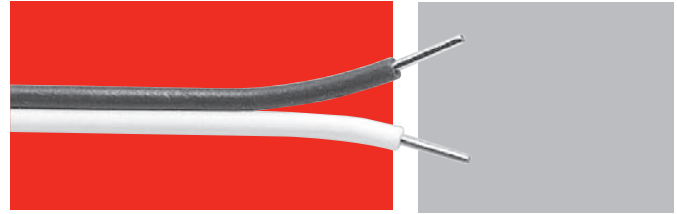

### Applications

- Laboratory
- Test stand
- Automotive

### Specifications

#### Continuous use temperature

- 220°F (105°C)

#### Single use temperature

- 220°F (105°C)

#### Resistance properties

- Moisture: Excellent
- Chemical: Good
- Abrasion: Good

## Popular Constructions

Grade	AWG	Wire Type	Limits of Error	Type K	Type J	Type T
Thermocouple	24	Solid	Standard	<b>K24-1-505</b>	<b>J24-1-505</b>	<b>T24-1-505</b>
		Solid	Special	<b>K24-2-505</b>	<b>J24-2-505</b>	<b>T24-2-505</b>

**Note:** Bolded products are stocked.

## Wire Specifications

AWG	Nominal Conductor Size		Nominal Conductor Insulation Thickness		Nominal Overall Size		Approximate Shipping Weight	
	in.	(mm)	in.	(mm)	in.	(mm)	lbs/1000 ft	(kg/km)
26	0.016	(0.406)	0.015	(0.381)	0.046 x 0.088	(1.17 x 2.24)	4	(6.0)
24	0.020	(0.508)	0.015	(0.381)	0.050 x 0.096	(1.27 x 2.44)	5	(7.5)

## Ordering Information

### Part Number

① ASTM E 230 Calibration	② ③ AWG	④ Conductor Type/ Tolerance	⑤	⑥	⑦
			<b>5</b>	<b>0</b>	<b>5</b>

①	ASTM E 230 Calibration
J	= Type J
K	= Type K
T	= Type T

② ③	AWG
26	= 26 gauge solid
24	= 24 gauge solid or 24 gauge stranded (7/32)
20	= 20 gauge solid or 20 gauge stranded (7/28)

④	Conductor Type/Tolerance
1	= Thermocouple grade, solid wire, standard tolerance
2	= Thermocouple grade, solid wire, special tolerance
3	= Thermocouple grade, stranded wire, standard tolerance
4	= Thermocouple grade, stranded wire, special tolerance

**Note:** Minimum order sizes apply for non-stock constructions.

# SERV-RITE Wire

## Thermocouple and Extension Wire Small Gauge Fluorinated Ethylene Propylene (FEP) Insulated SERIES 506

The SERIES 506 is the smallest standard insulated wire construction. The thin FEP wall on both primary and duplex insulation yields a construction that can operate safely at temperatures far beyond common PVC and nylon insulations.

The SERIES 506 is fully color coded for easy installation. Its small size allows use in high density circuits. Response time is minimized by small diameter conductors. For larger diameter gauge sizes than #28, specify SERIES 507.

### Performance Capabilities

- Continuous temperature rating: 400°F (204°C)
- Flexible FEP plastic insulation
- Thin insulation wall for a compact construction
- Available with an optional metallic overbraid for additional abrasion resistance

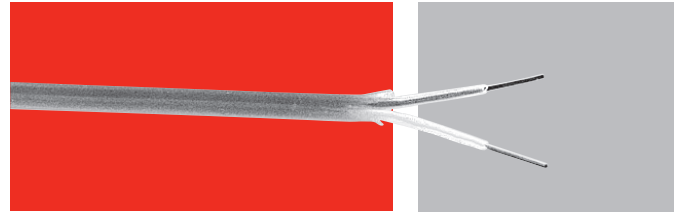

### Applications

- Laboratory
- Test stand
- Industrial equipment testing

### Specifications

#### Continuous use temperature

- 400°F (204°C)

#### Single use temperature

- 500°F (260°C)

#### Resistance properties

- Moisture: Excellent
- Chemical: Excellent
- Abrasion: Excellent

### Popular Constructions

Grade	AWG	Wire Type	Limits of Error	Type K	Type J	Type T
Thermocouple	28	Solid	Special	K28-2-506	J28-2-506	T28-2-506
	30	Solid	Special	<b>K30-2-506</b>	<b>J30-2-506</b>	<b>T30-2-506</b>
	36	Solid	Special	K36-2-506	J36-2-506	T36-2-506

**Note:** Bolded products are stocked.

### Wire Specifications

AWG	Nominal Conductor Size in. (mm)	Nominal Insulation Thickness		Nominal Overall Size in. (mm)	Approximate Shipping Weight lbs/1000 ft (kg/km)
		Conductor in. (mm)	Overall in. (mm)		
36	0.005 (0.127)	0.005 (0.127)	0.005 (0.127)	0.025 x 0.040 (0.635 x 1.02)	2 (3.0)
32	0.008 (0.203)	0.005 (0.127)	0.005 (0.127)	0.028 x 0.046 (0.711 x 1.17)	2 (3.0)
30	0.010 (0.254)	0.005 (0.127)	0.005 (0.127)	0.030 x 0.050 (0.762 x 1.27)	3 (4.5)
28	0.013 (0.330)	0.005 (0.127)	0.005 (0.127)	0.033 x 0.056 (0.838 x 1.42)	3 (4.5)

### Ordering Information

#### Part Number

①	② ③	④	⑤	⑥	⑦
ASTM E 230 Calibration	AWG	Conductor Type/Tolerance			
			5	0	6

①	ASTM E 230 Calibration
E	Type E
J	Type J
K	Type K
S	Type S
T	Type T

② ③	AWG
36	36 gauge solid
30	30 gauge solid
28	28 gauge solid

④	Conductor Type/Tolerance
1	Thermocouple grade, solid wire, standard tolerance
2	Thermocouple grade, solid wire, special tolerance

**Note:** Minimum order sizes apply for non-stock constructions.

# SERV-RITE Wire

## Thermocouple and Extension Wire

### FEP Insulated Thermocouple and Extension Wire SERIES 507

The SERIES 507 is the most economical fluoroplastic insulated wire. Individual conductors are coated with a layer of color coded FEP. The insulated conductors are then parallel duplexed with an additional layer of color coded FEP. The finished construction has a continuous temperature rating of 400°F (204°C). Abrasion, moisture and chemical resistance exceed most other insulations. This construction is widely used when pulling long lengths of wire through conduit. FEP's low friction coefficient and abrasion resistance are suited for these applications.

For higher abrasion resistance consider SERIES 514 Tefzel® insulated constructions.

For higher temperatures specify SERIES 508.

### Performance Capabilities

- Continuous temperature rating: 400°F (204°C)
- Flexible FEP plastic insulation
- Available with an optional metallic overbraid for additional abrasion resistance

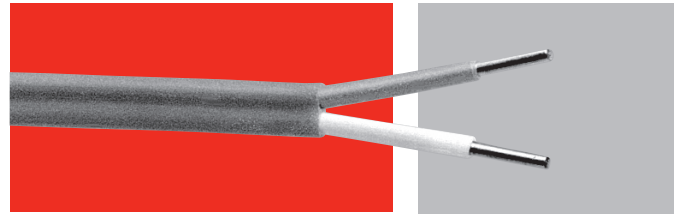

### Applications

- General use extension wire

### Specifications

#### Continuous use temperature

- 400°F (204°C)

#### Single use temperature

- 500°F (260°C)

#### Resistance properties

- Moisture: Excellent
- Chemical: Excellent
- Abrasion: Excellent

## Popular Constructions

Grade	AWG	Wire Type	Limits of Error	Type K	Type J	Type T	Type E	Type S
Extension	20	Solid	Standard	<b>K20-5-507</b>	<b>J20-5-507</b>	T20-5-507	E20-5-507	<b>S20-5-507</b>
	24	Solid	Standard					S24-5-507
Thermocouple	20	Solid	Standard	<b>K20-1-507</b>	<b>J20-1-507</b>	<b>T20-1-507</b>	<b>E20-1-507</b>	
		Stranded	Standard	<b>K20-3-507</b>	<b>J20-3-507</b>	<b>T20-3-507</b>	E20-3-507	
		Solid	Special	<b>K20-2-507</b>	<b>J20-2-507</b>	<b>T20-2-507</b>	E20-2-507	
	24	Solid	Standard	<b>K24-1-507</b>	<b>J24-1-507</b>	T24-1-507	E24-1-507	
		Stranded	Standard	<b>K24-3-507</b>	<b>J24-3-507</b>	T24-3-507	E24-3-507	
		Solid	Special	<b>K24-2-507</b>	<b>J24-2-507</b>	<b>T24-2-507</b>	E24-2-507	

Note: **Bolded** products are stocked.

## Wire Specifications

AWG	Nominal Conductor Size		Nominal Insulation Thickness			Nominal Overall Size		Approximate Shipping Weight		
			Conductor		Overall					
	in.	(mm)	in.	(mm)	in.	(mm)	in.	(mm)	lbs/1000 ft	(kg/km)
24	0.020	(0.508)	0.008	(0.203)	0.010	(0.254)	0.056 x 0.096	(1.42 x 2.44)	8	(11.9)
24 S* (7/32)	0.024	(0.610)	0.008	(0.203)	0.010	(0.254)	0.060 x 0.104	(1.52 x 2.64)	9	(13.4)
22	0.025	(0.635)	0.008	(0.203)	0.010	(0.254)	0.061 x 0.106	(1.55 x 2.69)	10	(14.9)
22 S* (7/30)	0.030	(0.762)	0.008	(0.203)	0.010	(0.254)	0.066 x 0.116	(1.68 x 2.95)	11	(16.4)
20	0.032	(0.813)	0.008	(0.203)	0.010	(0.254)	0.068 x 0.120	(1.73 x 3.05)	12	(17.9)
20 S* (7/28)	0.038	(0.965)	0.008	(0.203)	0.010	(0.254)	0.074 x 0.132	(1.88 x 3.35)	14	(20.9)
18	0.040	(1.02)	0.008	(0.203)	0.010	(0.254)	0.076 x 0.136	(1.93 x 3.45)	18	(26.8)
18 S* (7/26)	0.048	(1.22)	0.008	(0.203)	0.010	(0.254)	0.084 x 0.152	(2.13 x 3.86)	20	(29.8)

\* "S" denotes stranded wire: e.g., "24 S (7/32)" is seven strands of 32 gauge wire to make a 24 gauge stranded conductor.

# SERV-RITE Wire

## Thermocouple and Extension Wire

*FEP Insulated Thermocouple  
and Extension Wire SERIES 507 (Continued)*

### Ordering Information

#### Part Number

① ASTM E 230 Calibration	② ③ AWG	④ Conductor Type/ Tolerance	⑤	⑥	⑦
			5	0	7

①	ASTM E 230 Calibration
E =	Type E
J =	Type J
K =	Type K
S =	Type S
T =	Type T

② ③	AWG
24 =	24 gauge solid or 24 gauge stranded (7/32)
22 =	22 gauge solid or 22 gauge stranded (7/30)
20 =	20 gauge solid or 20 gauge stranded (7/28)

④	Conductor Type/Tolerance
1 =	Thermocouple grade, solid wire, standard tolerance
2 =	Thermocouple grade, solid wire, special tolerance
3 =	Thermocouple grade, stranded wire, standard tolerance
4 =	Thermocouple grade, stranded wire, special tolerance
5 =	Extension grade, solid wire, standard tolerance
6 =	Extension grade, solid wire, special tolerance
7 =	Extension grade, stranded wire, standard tolerance
8 =	Extension grade, stranded wire, special tolerance

**Note:** Minimum order sizes apply for non-stock constructions.

# SERV-RITE Wire

## Thermocouple and Extension Wire

### TFE Insulated SERIES 508

The primary and duplex insulation of SERIES 508 is fused TFE tape which is spirally applied to the conductor and heated. This process, called sintering, forms the tape into a homogeneous layer. When sintered, the tape exhibits all of the advantages of extruded TFE insulation, while eliminating the concentricity problems associated with TFE extrusions.

The SERIES 508 is fully color coded and capable of continuous operation in excess of 500°F (260°C). Because the fusing process causes the duplex tape to fuse with the primary insulation, SERIES 508 is not recommended for applications where it is necessary to remove the outer tape while leaving the primary insulation intact.

### Performance Capabilities

- Continuous temperature rating: 500°F (260°C)
- Fused TFE tape insulation
- Available with an optional metallic overbraid for additional abrasion resistance

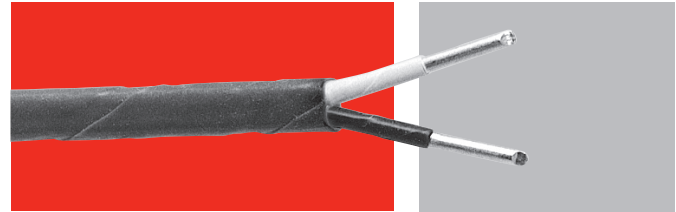

### Applications

- Aircraft
- Petroleum processing

### Specifications

#### Continuous use temperature

- 500°F (260°C)

#### Single use temperature

- 600°F (315°C)

#### Resistance properties

- Moisture: Excellent
- Chemical: Excellent
- Abrasion: Good

## Popular Constructions

Grade	AWG	Wire Type	Limits of Error	Type K	Type J	Type T	Type E
Thermocouple	20	Solid	Standard	<b>K20-1-508</b>	<b>J20-1-508</b>	T20-1-508	E20-1-508
		Stranded	Standard	K20-3-508	J20-3-508	T20-3-508	E20-3-508
		Solid	Special	<b>K20-2-508</b>	<b>J20-2-508</b>	<b>T20-2-508</b>	E20-2-508
	24	Solid	Standard	<b>K24-1-508</b>	<b>J24-1-508</b>	<b>T24-1-508</b>	E24-1-508
		Stranded	Standard	K24-3-508	J24-3-508	T24-3-508	E24-3-508
		Solid	Special	<b>K24-2-508</b>	<b>J24-2-508</b>	<b>T24-2-508</b>	E24-2-508

**Note:** Bolded products are stocked.

## Wire Specifications

AWG	Nominal Conductor Size in. (mm)		Nominal Insulation Thickness				Nominal Overall Size in. (mm)		Approximate Shipping Weight lbs/1000 ft (kg/km)	
			Conductor in. (mm)		Overall in. (mm)					
26	0.016	(0.406)	0.006	(0.152)	0.008	(0.203)	0.044 x 0.072	(1.12 x 1.83)	4	(6.0)
24	0.020	(0.508)	0.006	(0.152)	0.008	(0.203)	0.047 x 0.077	(1.19 x 1.95)	5	(7.5)
24 S* (7/32)	0.024	(0.610)	0.006	(0.152)	0.008	(0.203)	0.049 x 0.084	(1.24 x 2.13)	6	(8.9)
20	0.032	(0.813)	0.006	(0.152)	0.008	(0.203)	0.061 x 0.106	(1.55 x 2.69)	11	(16.4)
20 S* (7/28)	0.038	(0.965)	0.006	(0.152)	0.008	(0.203)	0.064 x 0.112	(1.63 x 2.84)	12	(17.9)
18	0.040	(1.02)	0.006	(0.152)	0.008	(0.203)	0.068 x 0.120	(1.73 x 3.05)	16	(23.8)
18 S* (7/26)	0.048	(1.22)	0.006	(0.152)	0.008	(0.203)	0.076 x 0.136	(1.93 x 3.45)	18	(26.8)

\* "S" denotes stranded wire: e.g., "24 S (7/32)" is seven strands of 32 gauge wire to make a 24 gauge stranded conductor.



# SERV-RITE Wire

## Thermocouple and Extension Wire

TFE Insulated SERIES 508 (Continued)

### Ordering Information

Part Number

① ASTM E 230 Calibration	② ③ AWG	④ Conductor Type/ Tolerance	⑤	⑥	⑦
			5	0	8

①	ASTM E 230 Calibration
E =	Type E
J =	Type J
K =	Type K
S =	Type S
T =	Type T

② ③	AWG
26 =	26 gauge solid
24 =	24 gauge solid or 24 gauge stranded (7/32)
20 =	20 gauge solid or 20 gauge stranded (7/28)

④	Conductor Type/Tolerance
1 =	Thermocouple grade, solid wire, standard tolerance
2 =	Thermocouple grade, solid wire, special tolerance
3 =	Thermocouple grade, stranded wire, standard tolerance
4 =	Thermocouple grade, stranded wire, special tolerance

**Note:** Minimum order sizes apply for non-stock constructions.

# SERV-RITE Wire

## Thermocouple and Extension Wire

### FEP Insulated and Shielded Thermocouple and Extension Wire SERIES 509

The SERIES 509 was developed specially for use with microprocessor-based systems.

The conductors are insulated with color coded FEP. They are then twisted with a copper drain wire. An aluminized polyester tape is wrapped around the conductors and drain wire and then FEP is applied.

The finished construction can withstand temperatures in excess of 400°F (204°C). Twisted conductors minimize electromagnetic interference (EMI) and the shield tape eliminates most problems associated with AC “noise” in the sensing circuit.

#### Performance Capabilities

- Continuous temperature rating: 400°F (204°C)
- Flexible FEP plastic insulation
- Twisted and shielded construction to reduce electrical noise interference
- Available with an optional metallic overbraid for additional abrasion resistance

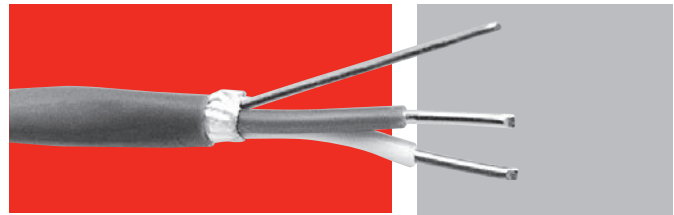

#### Applications

- General use extension wire

#### Specifications

##### Continuous use temperature

- 400°F (204°C)

##### Single use temperature

- 500°F (260°C)

##### Resistance properties

- Moisture: Excellent
- Chemical: Excellent
- Abrasion: Excellent

## Popular Constructions

Grade	AWG	Wire Type	Limits of Error	Type K	Type J	Type T	Type E	Type S
Extension	16	Solid	Standard	<b>K16-5-509</b>	<b>J16-5-509</b>			
		Stranded	Standard	K16-7-509	J16-7-509			
	20	Solid	Standard	<b>K20-5-509</b>	<b>J20-5-509</b>	T20-5-509	E20-5-509	S20-5-509
		Stranded	Standard	K20-7-509	J20-7-509	T20-7-509		
Thermocouple	20	Solid	Standard	<b>K20-1-509</b>	<b>J20-1-509</b>	<b>T20-1-509</b>		
		Solid	Special	<b>K20-2-509</b>	J20-2-509	T20-2-509		
	24	Solid	Standard	K24-1-509	J24-1-509	T24-1-509		
		Stranded	Standard	K24-3-509	J24-3-509	T24-3-509		

**Note:** Bolded products are stocked.

## Wire Specifications

AWG	Nominal Conductor Size in. (mm)		Nominal Insulation Thickness		Nominal Overall Size in. (mm)		Approximate Shipping Weight lbs/1000 ft (kg/km)	
			Conductor in. (mm)	Overall in. (mm)				
24	0.020	(0.508)	0.008 (0.203)	0.012 (0.305)	0.104	(2.64)	12	(17.9)
24 S* (7/32)	0.024	(0.610)	0.008 (0.203)	0.012 (0.305)	0.112	(2.84)	13	(19.4)
20	0.032	(0.813)	0.008 (0.203)	0.012 (0.305)	0.128	(3.25)	18	(26.8)
20 S* (7/28)	0.038	(0.965)	0.008 (0.203)	0.012 (0.305)	0.140	(3.56)	20	(29.8)
18	0.040	(1.02)	0.008 (0.203)	0.015 (0.381)	0.152	(3.86)	25	(37.3)
18 S* (7/26)	0.048	(1.22)	0.008 (0.203)	0.015 (0.381)	0.168	(4.27)	27	(40.2)
16	0.051	(1.29)	0.008 (0.203)	0.015 (0.381)	0.174	(4.42)	33	(49.2)
16 S* (7/24)	0.060	(1.52)	0.008 (0.203)	0.015 (0.381)	0.192	(4.88)	35	(52.2)

\* “S” denotes stranded wire: e.g., “24 S (7/32)” is seven strands of 32 gauge wire to make a 24 gauge stranded conductor.

# SERV-RITE Wire

## Thermocouple and Extension Wire

*FEP Insulated and Shielded Thermocouple and Extension Wire SERIES 509 (Continued)*

### Ordering Information

Part Number

① ASTM E 230 Calibration	② ③ AWG	④ Conductor Type/ Tolerance	⑤	⑥	⑦
			5	0	9

①	ASTM E 230 Calibration
E =	Type E
J =	Type J
K =	Type K
S =	Type S
T =	Type T

② ③	AWG
24 =	24 gauge solid or 24 gauge stranded (7/32)
20 =	20 gauge solid or 20 gauge stranded (7/28)
16 =	16 gauge solid or 16 gauge stranded (7/24)

④	Conductor Type/Tolerance
1 =	Thermocouple grade, solid wire, standard tolerance
2 =	Thermocouple grade, solid wire, special tolerance
3 =	Thermocouple grade, stranded wire, standard tolerance
4 =	Thermocouple grade, stranded wire, special tolerance
5 =	Extension grade, solid wire, standard tolerance
6 =	Extension grade, solid wire, special tolerance
7 =	Extension grade, stranded wire, standard tolerance
8 =	Extension grade, stranded wire, special tolerance

**Note:** Minimum order sizes apply for non-stock constructions.

# SERV-RITE Wire

## Thermocouple and Extension Wire

### PVC Insulated and Shielded Thermocouple and Extension Wire SERIES 510

The SERIES 510 is a PVC insulated, twisted and shielded construction for systems sensitive to induced voltages and “noise.”

The conductors are insulated with color coded PVC and then twisted with a copper drain wire. An aluminized polyester tape is wrapped around the two conductors and drain wires to impart 100 percent shielding. Then, another layer of PVC is applied.

The twisting eliminates most EMI while the shield tape minimizes AC “noise” in the sensing circuit.

#### Performance Capabilities

- Continuous temperature rating: 220°F (105°C)
- Flexible PVC plastic insulation
- Twisted and shielded construction to reduce electrical noise interference
- Available with an optional metallic overbraid for additional abrasion resistance

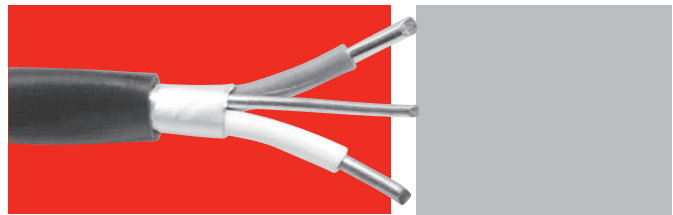

#### Applications

- General use extension wire

#### Specifications

##### Continuous use temperature

- 220°F (105°C)

##### Single use temperature

- 220°F (105°C)

##### Resistance properties

- Moisture: Excellent
- Chemical: Good
- Abrasion: Good

## Popular Constructions

Grade	AWG	Wire Type	Limits of Error	Type K	Type J	Type T	Type E	Type S
Extension	16	Solid	Standard	<b>K16-5-510</b>	<b>J16-5-510</b>	<b>T16-5-510</b>		
		Stranded	Standard	K16-7-510	J16-7-510	T16-7-510		
	20	Solid	Standard	<b>K20-5-510</b>	<b>J20-5-510</b>	<b>T20-5-510</b>	<b>E20-5-510</b>	<b>S20-5-510</b>
		Stranded	Standard	<b>K20-7-510</b>	<b>J20-7-510</b>	T20-7-510		
	24	Solid	Standard	K24-5-510	J24-5-510	T24-5-510		
		Stranded	Standard	K24-7-510	J24-7-510	T24-7-510		

**Note:** Bolded products are stocked.

## Wire Specifications

AWG	Nominal Conductor Size in. (mm)		Nominal Insulation Thickness		Nominal Overall Size in. (mm)		Approximate Shipping Weight lbs/1000 ft (kg/km)	
			Conductor in. (mm)	Overall in. (mm)				
24	0.020	(0.508)	0.015 (0.381)	0.020 (0.508)	0.140	(3.56)	13	(19.4)
24 S* (7/32)	0.024	(0.610)	0.015 (0.381)	0.020 (0.508)	0.148	(3.76)	14	(20.9)
20	0.032	(0.813)	0.015 (0.381)	0.020 (0.508)	0.164	(4.17)	22	(32.8)
20 S* (7/28)	0.038	(0.965)	0.015 (0.381)	0.020 (0.508)	0.176	(4.47)	24	(35.8)
18	0.040	(1.02)	0.020 (0.508)	0.020 (0.508)	0.200	(5.08)	30	(44.7)
18 S* (7/26)	0.048	(1.22)	0.020 (0.508)	0.020 (0.508)	0.216	(5.49)	32	(47.7)
16	0.051	(1.29)	0.020 (0.508)	0.020 (0.508)	0.222	(5.64)	39	(58.1)
16 S* (7/24)	0.060	(1.52)	0.020 (0.508)	0.020 (0.508)	0.240	(6.10)	41	(61.1)

\* “S” denotes stranded wire: e.g., “24 S (7/32)” is seven strands of 32 gauge wire to make a 24 gauge stranded conductor.

# SERV-RITE Wire

## Thermocouple and Extension Wire

*PVC Insulated and Shielded Thermocouple and Extension Wire SERIES 510 (Continued)*

### Ordering Information

Part Number

①	② ③	④	⑤	⑥	⑦
ASTM E 230 Calibration	AWG	Conductor Type/Tolerance			
			5	1	0

①	ASTM E 230 Calibration
E =	Type E
J =	Type J
K =	Type K
S =	Type S
T =	Type T

② ③	AWG
24 =	24 gauge solid or 24 gauge stranded (7/32)
20 =	20 gauge solid or 20 gauge stranded (7/28)
16 =	16 gauge solid or 16 gauge stranded (7/24)

④	Conductor Type/Tolerance
1 =	Thermocouple grade, solid wire, standard tolerance
2 =	Thermocouple grade, solid wire, special tolerance
3 =	Thermocouple grade, stranded wire, standard tolerance
4 =	Thermocouple grade, stranded wire, special tolerance
5 =	Extension grade, solid wire, standard tolerance
6 =	Extension grade, solid wire, special tolerance
7 =	Extension grade, stranded wire, standard tolerance
8 =	Extension grade, stranded wire, special tolerance

**Note:** Minimum order sizes apply for non-stock constructions.

# SERV-RITE Wire

## Thermocouple and Extension Wire *Polyimide Insulated and Twisted SERIES 511*

SERIES 511 is the most economical polyimide taped construction. Polyimide film applied to the conductors is considered to be the ultimate “soft” insulation. The tape maintains its strength at temperatures up to 600°F (315°C). The FEP laminate serves as a moisture barrier and allows the tape to fuse with itself. The finished construction will not unravel when cut.

SERIES 511 conductors are wrapped with the polyimide tape which is fused to itself. Each conductor is color coded with a colored thread under the tape. The insulated conductors are twisted into a duplex construction to eliminate the overall duplex insulation and minimize cost.

### Performance Capabilities

- Continuous temperature rating: 600°F (315°C)
- Polyimide fused tape insulation
- Twisted design has no outer jacket
- Colored tracer used to indicate calibration type
- Available with an optional metallic overbraid for additional abrasion resistance

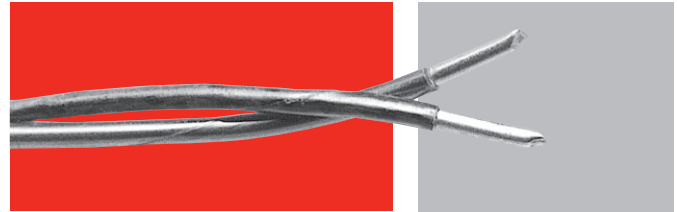

### Applications

- Aerospace
- Petrochemical
- Plastics

### Specifications

#### Continuous use temperature

- 600°F (315°C)

#### Single use temperature

- 800°F (430°C)

#### Resistance properties

- Moisture: Excellent
- Chemical: Excellent
- Abrasion: Excellent

## Popular Constructions

Grade	AWG	Wire Type	Limits of Error	Type K	Type J
Thermocouple	20	Solid	Standard	K20-1-511	J20-1-511
		Solid	Special	K20-2-511	J20-2-511
	24	Solid	Standard	K24-1-511	J24-1-511
		Solid	Special	K24-2-511	<b>J24-2-511</b>

**Note:** Bolded products are stocked.

## Wire Specifications

AWG	Nominal Conductor Size		Nominal Conductor Insulation Thickness		Nominal Overall Size		Approximate Shipping Weight	
	in.	(mm)	in.	(mm)	in.	(mm)	lbs/1000 ft	(kg/km)
30	0.010	(0.254)	0.004	(0.102)	0.040	(1.02)	3	(4.5)
24	0.020	(0.508)	0.005	(0.127)	0.060	(1.52)	4	(6.0)
24 S* (7/32)	0.024	(0.610)	0.005	(0.127)	0.068	(1.73)	5	(7.5)
20	0.032	(0.813)	0.005	(0.127)	0.084	(2.13)	8	(11.9)
20 S* (7/28)	0.038	(0.965)	0.005	(0.127)	0.094	(2.39)	9	(13.4)

**Note:** FEP laminate melts at approximately 260°C (500°F).

\* “S” denotes stranded wire: e.g., “24 S (7/32)” is seven strands of 32 gauge wire to make a 24 gauge stranded conductor.

# SERV-RITE Wire

## Thermocouple and Extension Wire

*Polyimide Insulated and Twisted SERIES 511  
(Continued)*

### Ordering Information

Part Number

① ASTM E 230 Calibration	② ③ AWG	④ Conductor Type/ Tolerance	⑤	⑥	⑦
			5	1	1

① ASTM E 230 Calibration	
J =	Type J
K =	Type K
T =	Type T

② ③ AWG	
30 =	30 gauge solid
24 =	24 gauge solid or 24 gauge stranded (7/32)
20 =	20 gauge solid or 20 gauge stranded (7/28)
16 =	16 gauge solid

④ Conductor Type/Tolerance	
1 =	Thermocouple grade, solid wire, standard tolerance
2 =	Thermocouple grade, solid wire, special tolerance
3 =	Thermocouple grade, stranded wire, standard tolerance
4 =	Thermocouple grade, stranded wire, special tolerance

**Note:** Minimum order sizes apply for non-stock constructions.

# SERV-RITE Wire

## Thermocouple and Extension Wire

### Polyimide Insulated SERIES 512

The SERIES 512 is a heavier duty version of SERIES 511 construction, using the same polyimide insulation. Color coding is accomplished using the same colored thread “tracers.” The SERIES 512 has a duplex insulation of polyimide tape. The extra wall of tape yields a construction with increased abrasion resistance.

For higher temperature requirements, choose one of our fiberglass insulated wires.

For improved abrasion resistance, and easier color identification of conductors, specify SERIES 513 when contacting the factory.

### Performance Capabilities

- Continuous temperature rating: 600°F (315°C)
- Polyimide fused tape insulation
- Colored tracer used to indicate calibration type
- Available with an optional metallic overbraid for additional abrasion resistance

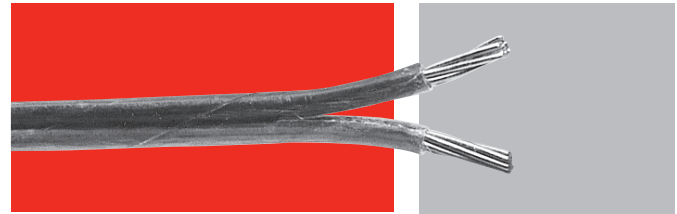

### Applications

- Aerospace
- Petrochemical
- Plastics

### Specifications

#### Continuous use temperature

- 600°F (315°C)

#### Single use temperature

- 800°F (430°C)

#### Resistance properties

- Moisture: Excellent
- Chemical: Excellent
- Abrasion: Excellent

## Popular Constructions

Grade	AWG	Wire Type	Limits of Error	Type K	Type J
Thermocouple	20	Solid	Standard	K20-1-512	<b>J20-1-512</b>
		Solid	Special	K20-2-512	J20-2-512
		Stranded	Standard	<b>K20-3-512</b>	<b>J20-3-512</b>
	24	Solid	Standard	K24-1-512	J24-1-512
		Solid	Special	K24-2-512	J24-2-512

**Note:** Bolded products are stocked.

## Wire Specifications

AWG	Nominal Conductor Size		Nominal Insulation Thickness				Nominal Overall Size		Approximate Shipping Weight	
			Conductor		Overall					
	in.	(mm)	in.	(mm)	in.	(mm)	in.	(mm)	lbs/1000 ft	(kg/km)
30	0.010	(0.254)	0.004	(0.102)	0.005	(0.127)	0.026 x 0.044	(0.660 x 1.18)	3	(4.5)
24	0.020	(0.508)	0.005	(0.127)	0.005	(0.127)	0.036 x 0.064	(0.914 x 1.626)	5	(7.5)
24 S* (7/32)	0.024	(0.610)	0.005	(0.127)	0.005	(0.127)	0.043 x 0.066	(1.092 x 1.676)	6	(8.9)
20	0.032	(0.813)	0.005	(0.127)	0.005	(0.127)	0.048 x 0.088	(1.219 x 2.235)	8	(11.9)
20 S* (7/28)	0.038	(0.965)	0.005	(0.127)	0.005	(0.127)	0.056 x 0.098	(1.42 x 2.490)	9	(13.4)

**Note:** FEP laminate melts at approximately 260°C (500°F).

\* “S” denotes stranded wire: e.g., “24 S (7/32)” is seven strands of 32 gauge wire to make a 24 gauge stranded conductor.



# SERV-RITE Wire

## Thermocouple and Extension Wire

*Polyimide Insulated SERIES 512 (Continued)*

### Ordering Information

Part Number

① ASTM E 230 Calibration	② ③ AWG	④ Conductor Type/ Tolerance	⑤	⑥	⑦
			5	1	2

①	ASTM E 230 Calibration
E =	Type E
J =	Type J
K =	Type K
T =	Type T

② ③	AWG
30 =	30 gauge solid
24 =	24 gauge solid or 24 gauge stranded (7/32)
20 =	20 gauge solid or 20 gauge stranded (7/28)

④	Conductor Type/Tolerance
1 =	Thermocouple grade, solid wire, standard tolerance
2 =	Thermocouple grade, solid wire, special tolerance
3 =	Thermocouple grade, stranded wire, standard tolerance
4 =	Thermocouple grade, stranded wire, special tolerance

**Note:** Minimum order sizes apply for non-stock constructions.

# SERV-RITE Wire

## Thermocouple and Extension Wire

### PFA Insulated Thermocouple and Extension Wire SERIES 516

A relatively new fluoroplastic, perfluoroalkoxy (PFA), is the insulation used for SERIES 516. PFA's temperature rating is only slightly less than TFE. However, PFA can be applied using conventional extrusion techniques. This produces a smooth finish, as opposed to the spiral usually associated with TFE tape constructions. This is important in the foodservice industry where taped constructions present cleaning problems. The smooth surface also allows this construction to be pulled through conduits and cut-outs more easily.

Once each conductor has been coated with a color coded PFA layer, they are laid parallel and coated again with PFA.

#### Performance Capabilities

- Continuous temperature rating: 500°F (260°C)
- Flexible PFA plastic insulation
- Available with an optional metallic overbraid for additional abrasion resistance

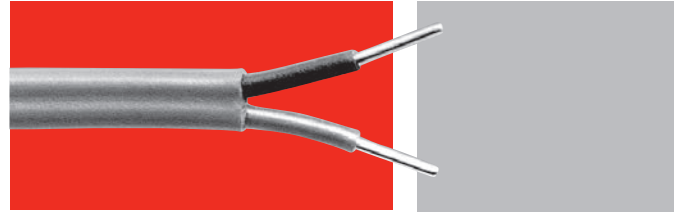

#### Applications

- General use extension wire

#### Specifications

##### Continuous use temperature

- 500°F (260°C)

##### Single use temperature

- 550°F (290°C)

##### Resistance properties

- Moisture: Excellent
- Chemical: Excellent
- Abrasion: Good

## Popular Constructions

Grade	AWG	Wire Type	Limits of Error	Type K	Type J	Type T	Type E
Thermocouple	20	Solid	Standard	K20-1-516	J20-1-516	T20-1-516	E20-1-516
		Solid	Special	K20-2-516	J20-2-516	T20-2-516	E20-2-516
		Stranded	Standard	K20-3-516	J20-3-516	T20-3-516	E20-3-516
	24	Solid	Standard	K24-1-516	J24-1-516	T20-1-516	E24-1-516
		Solid	Special	<b>K24-2-516</b>	J24-2-516	T20-2-516	E24-2-516
		Stranded	Standard	K24-3-516	<b>J24-3-516</b>	T20-3-516	E24-3-516

**Note:** Bolded products are stocked.

## Wire Specifications

AWG	Nominal Conductor Size		Nominal Insulation Thickness				Nominal Overall Size		Approximate Shipping Weight	
			Conductor		Overall					
	in.	(mm)	in.	(mm)	in.	(mm)	in.	(mm)	lbs/1000 ft	(kg/km)
36	0.005	(0.127)	0.003	(0.076)	0.003	(0.076)	0.017 x 0.028	(0.432 x 0.711)	3.0	(2)
30	0.010	(0.254)	0.003	(0.076)	0.003	(0.076)	0.022 x 0.038	(0.559 x 0.965)	4.5	(3)
24	0.020	(0.508)	0.008	(0.203)	0.010	(0.254)	0.056 x 0.092	(1.42 x 2.34)	11.9	(8)
24 S* (7/32)	0.024	(0.610)	0.008	(0.203)	0.010	(0.254)	0.060 x 0.100	(1.52 x 2.54)	13.4	(9)
20	0.032	(0.813)	0.008	(0.203)	0.010	(0.254)	0.068 x 0.116	(1.73 x 2.95)	17.9	(12)
20 S* (7/28)	0.038	(0.965)	0.008	(0.203)	0.010	(0.254)	0.074 x 0.128	(1.88 x 3.25)	20.9	(14)

\* "S" denotes stranded wire: e.g., "24 S (7/32)" is seven strands of 32 gauge wire to make a 24 gauge stranded conductor.

# SERV-RITE Wire

## Thermocouple and Extension Wire

### PFA Insulated Thermocouple and Extension Wire SERIES 516 (Continued)

#### Ordering Information

##### Part Number

① ASTM E 230 Calibration	② ③ AWG	④ Conductor Type/ Tolerance	⑤	⑥	⑦
			5	1	6

①	ASTM E 230 Calibration
E =	Type E
J =	Type J
K =	Type K
S =	Type S
T =	Type T

② ③	AWG
36 =	36 gauge solid
30 =	30 gauge solid
24 =	24 gauge solid or 24 gauge stranded (7/32)
20 =	20 gauge solid or 20 gauge stranded (7/28)

④	Conductor Type/Tolerance
1 =	Thermocouple grade, solid wire, standard tolerance
2 =	Thermocouple grade, solid wire, special tolerance
3 =	Thermocouple grade, stranded wire, standard tolerance
4 =	Thermocouple grade, stranded wire, special tolerance
5 =	Extension grade, solid wire, standard tolerance
6 =	Extension grade, solid wire, special tolerance
7 =	Extension grade, stranded wire, standard tolerance
8 =	Extension grade, stranded wire, special tolerance

**Note:** Minimum order sizes apply for non-stock constructions.

# SERV-RITE Wire

## RTD Lead Wire

### SERIES 701, 704, 705 and 707

Watlow's quality, experience and versatility extend from insulated thermocouple and extension wire to resistance temperature detector (RTD) lead wire and fiberglass wire.

### Performance Capabilities

- Continuous temperature rating: 220 to 900°F (105 to 480°C) depending upon construction
- Available with an optional metallic overbraid for additional abrasion resistance

### Applications

- General use RTD sensor wire

### Specifications

#### PVC

##### Continuous use temperature

- 220°F (105°C)

##### Single use temperature

- 220°F (105°C)

##### Resistance properties

- Moisture: Excellent
- Chemical: Good
- Abrasion: Good

#### FEP

##### Continuous use temperature

- 400°F (204°C)

##### Single use temperature

- 500°F (260°C)

##### Resistance properties

- Moisture: Excellent
- Chemical: Excellent
- Abrasion: Excellent

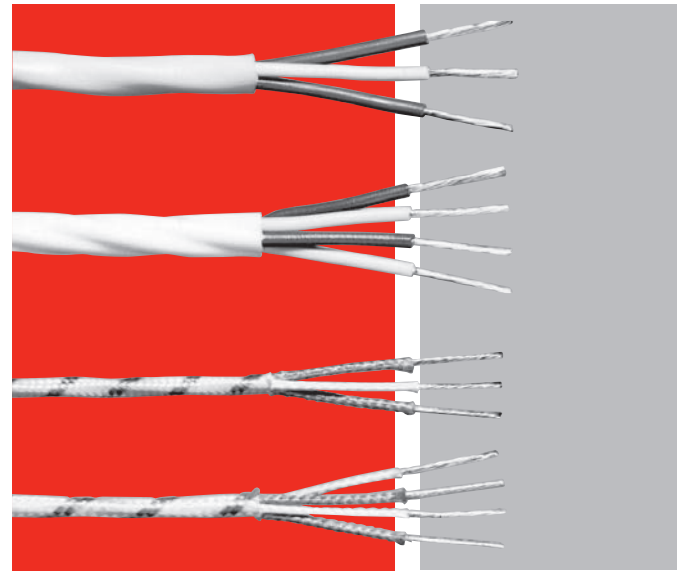

#### PFA

##### Continuous use temperature

- 500°F (260°C)

##### Single use temperature

- 550°F (290°C)

##### Resistance properties

- Moisture: Excellent
- Chemical: Excellent
- Abrasion: Good

#### Fiberglass

##### Continuous use temperature

- 900°F (480°C)

##### Single use temperature

- 1000°F (540°C)

##### Resistance properties

- Moisture: Good
- Chemical: Good
- Abrasion: Fair

## Popular Constructions

No. of Conductors	AWG	Wire Type*	Insulation Material			
			PVC 220°F (105°C)	FEP 400°F (204°C)	PFA 500°F (260°C)	Fiberglass 900°F (480°C)
2	22	Nickel plated copper	RT2-22-8-701	RT2-22-8-704		RT2-22-8-705
	24	Nickel plated copper	RT2-24-8-701	RT2-24-8-704	RT2-24-8-707	RT2-24-8-705
3	22	Tinned copper	<b>RT3-22-4-701</b>			
		Nickel plated copper	RT3-22-8-701	<b>RT3-22-8-704</b>		RT3-22-8-705
	24	Nickel plated copper	RT3-24-8-701	RT3-24-8-704	RT3-24-8-707	<b>RT3-24-8-705</b>
4	22	Nickel plated copper		RT4-22-8-704		RT4-22-8-705
	24	Nickel plated copper		RT4-24-8-704	RT4-24-8-707	RT4-24-8-705

Note: Bolded products are stocked.

# SERV-RITE Wire

## RTD Lead Wire

**SERIES 701, 704, 705 and 707 (Continued)**

### Wire Specifications - SERIES 701 - PVC

No. of Conductors	AWG	Nominal Conductor Size in. (mm)		Nominal Insulation Thickness		Nominal Overall Size in. (mm)		Approximate Shipping Weight lbs/1000 ft (kg/km)			
				Conductor in. (mm)	Overall in. (mm)						
2	22S* (7/30)	0.030	(0.762)	0.015	(0.381)	0.020	(0.508)	0.160	(4.06)	17	(25.3)
	20S* (7/28)	0.038	(0.965)	0.015	(0.381)	0.020	(0.508)	0.176	(4.47)	19	(28.3)
3	22S* (7/30)	0.030	(0.762)	0.015	(0.381)	0.020	(0.508)	0.172	(4.37)	20	(29.8)
	20S* (7/28)	0.038	(0.965)	0.015	(0.381)	0.020	(0.508)	0.190	(4.83)	25	(37.3)
4	22S* (7/30)	0.030	(0.762)	0.015	(0.381)	0.020	(0.508)	0.184	(4.67)	23	(34.3)
	20S* (7/28)	0.038	(0.965)	0.015	(0.381)	0.020	(0.508)	0.204	(5.18)	30	(44.7)

**Note:** 24 and 16 gauge constructions also available, contact factory for details.

### Wire Specifications - SERIES 704 - FEP

No. of Conductors	AWG	Nominal Conductor Size in. (mm)		Nominal Insulation Thickness		Nominal Overall Size in. (mm)		Approximate Shipping Weight lbs/1000 ft (kg/km)			
				Conductor in. (mm)	Overall in. (mm)						
2	24S* (7/32)	0.024	(0.610)	0.008	(0.203)	0.010	(0.254)	0.118	(3.00)	12	(17.9)
	22S* (7/30)	0.030	(0.762)	0.008	(0.203)	0.010	(0.254)	0.130	(3.30)	14	(20.9)
	20S* (7/28)	0.038	(0.965)	0.008	(0.203)	0.010	(0.254)	0.146	(3.71)	17	(25.3)
3	24S* (7/32)	0.024	(0.610)	0.008	(0.203)	0.010	(0.254)	0.126	(3.20)	16	(23.8)
	22S* (7/30)	0.030	(0.762)	0.008	(0.203)	0.010	(0.254)	0.140	(3.56)	20	(29.8)
	20S* (7/28)	0.038	(0.965)	0.008	(0.203)	0.010	(0.254)	0.158	(4.01)	24	(35.8)
4	24S* (7/32)	0.024	(0.610)	0.008	(0.203)	0.010	(0.254)	0.136	(3.46)	19	(28.3)
	22S* (7/30)	0.030	(0.762)	0.008	(0.203)	0.010	(0.254)	0.150	(3.81)	23	(34.3)
	20S* (7/28)	0.038	(0.965)	0.008	(0.203)	0.010	(0.254)	0.170	(4.32)	27	(40.2)

### Wire Specifications - SERIES 707 - PFA

No. of Conductors	AWG	Nominal Conductor Size in. (mm)		Nominal Insulation Thickness		Nominal Overall Size in. (mm)		Approximate Shipping Weight lbs/1000 ft (kg/km)			
				Conductor in. (mm)	Overall in. (mm)						
2	24S* (7/32)	0.024	(0.610)	0.008	(0.203)	0.010	(0.254)	0.108	(2.74)	12	(17.9)
3	24S* (7/32)	0.024	(0.610)	0.008	(0.203)	0.010	(0.254)	0.115	(2.91)	16	(23.8)
4	24S* (7/32)	0.024	(0.610)	0.008	(0.203)	0.010	(0.254)	0.126	(3.20)	19	(28.8)

### Wire Specifications - SERIES 705 - Fiberglass

No. of Conductors	AWG	Nominal Conductor Size in. (mm)		Nominal Insulation Thickness		Nominal Overall Size in. (mm)		Approximate Shipping Weight			
				Conductor in. (mm)	Overall in. (mm)			kg/km	(lbs/1000 ft)		
2	24S* (7/32)	0.024	(0.610)	0.005	(0.127)	0.006	(0.152)	0.080	(2.03)	6	(8.9)
	22S* (7/30)	0.030	(0.762)	0.005	(0.127)	0.006	(0.152)	0.092	(2.34)	7	(10.4)
	20S* (7/28)	0.038	(0.965)	0.006	(0.152)	0.006	(0.152)	0.112	(2.84)	9	(13.4)
3	24S* (7/32)	0.024	(0.610)	0.005	(0.127)	0.006	(0.152)	0.086	(2.18)	8	(11.9)
	22S* (7/30)	0.030	(0.762)	0.005	(0.127)	0.006	(0.152)	0.098	(2.49)	9	(13.4)
	20S* (7/28)	0.038	(0.965)	0.006	(0.152)	0.006	(0.152)	0.120	(3.05)	12	(17.9)
4	24S* (7/32)	0.024	(0.610)	0.005	(0.127)	0.006	(0.152)	0.092	(2.34)	10	(14.9)
	22S* (7/30)	0.030	(0.762)	0.005	(0.127)	0.006	(0.152)	0.106	(2.69)	12	(17.9)
	20S* (7/28)	0.038	(0.965)	0.006	(0.152)	0.006	(0.152)	0.130	(3.30)	16	(23.8)

\* "S" denotes stranded wire: e.g., "24 S (7/32)" is seven strands of 32 gauge wire to make a 24 gauge stranded conductor.

# SERV-RITE Wire

## RTD Lead Wire

*SERIES 701, 704, 705 and 707 (Continued)*

### Ordering Information

Part Number

①	②	③	④ ⑤	⑥	⑦ ⑧ ⑨
		Number of Conductors	AWG	Conductor Type/Tolerance	Insulation Type
R	T				

③	Number of Conductors
2 =	Type 2
3 =	Type 3
4 =	Type 4

④ ⑤	AWG
24 =	24 gauge solid
22 =	22 gauge solid
20 =	20 gauge solid

⑥	Conductor Type/Tolerance
4 =	Stranded tinned copper
8 =	Stranded nickel plated copper

⑦ ⑧ ⑨	Insulation Type
701 =	PVC
704 =	FEP
705 =	Fiberglass
707 =	PFA

**Note:** Minimum order sizes apply for non-stock constructions.

# Mineral Insulated Cable

Product	Description	Page
<b>XACTPAK® Cable</b>	XACTPAK cable is fireproof, high-pressure rated, cold and thermal shock resistant, gas tight, moisture proof, formable, weldable, corrosion resistant and high temperature rated. Diameters down to 0.020 in. (0.5 mm) and temperature ranges from 32 to 2700°F (0 to 1480°C).	<b>183</b>

Mineral Insulated Cable







# Mineral Insulated Cable

## XACTPAK® Cable

Watlow's XACTPAK® mineral insulated, metal-sheathed cable is ideally suited to solve a wide variety of problem applications.

The outer sheath can be made from any malleable metal in a wide range of diameters, containing single or multiple wires. Easily formed or bent, it can accommodate virtually any configuration. The outer sheath protects thermocouple or thermocouple extension wires from oxidation and hostile environments that would quickly destroy unprotected wire.

The mineral insulations available provide excellent high temperature dielectric strength to ensure signals are carried faithfully to the instrumentation or controls.

### Performance Capabilities

- Available in standard and special limits of error accuracy
- Diameters from 0.020 to 0.5 in. (0.5 to 12.7 mm)
- Compliance with recognized agency tolerances and specifications
- Sheath materials available to withstand a wide variety of hostile and corrosive environments
- Calibrated for intended temperature range
- Temperature ranges from 32 to 2200°F (0 to 1205°C)
- Cryogenic cable available upon request

### Features and Benefits

#### Fireproof cable

- Performs where conventional insulated wires burn and degrade

#### Fast and accurate

- Precisely measures temperature for a fast response

#### Tight moisture and gas seals

- Resists contamination

#### High pressure rating

- Allows use in pressure vessels and vacuum applications

#### Form flexibility

- Adapts to virtually any application

#### Thermal shock resistance

- Withstands thermal cycling

#### Compact, durable and corrosion resistant

- Ensures long-life performance with minimum constraints on applications

#### High temperature rating

- Meets demanding application needs

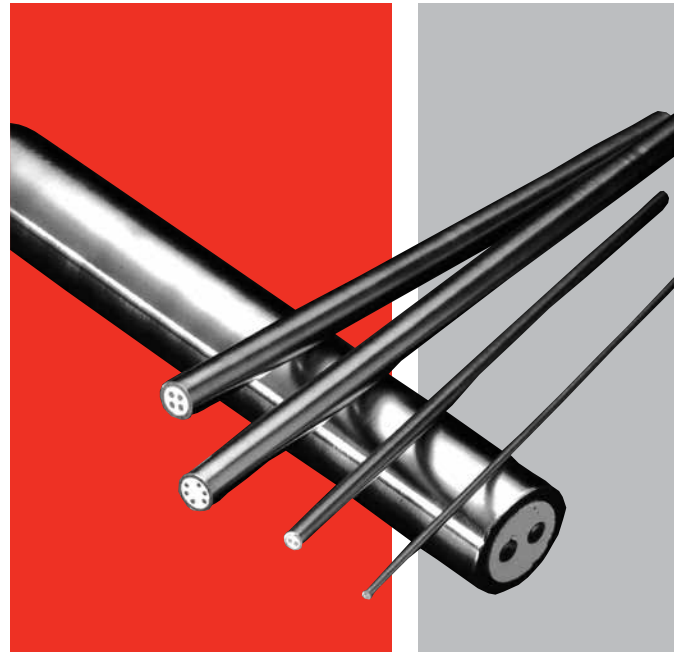

### Typical Applications

- Atomic research
- Bearing temperature
- Blast furnaces
- Catalytic reformers
- Diesel engines
- Foodservice and beverage
- Furnaces
- Glass and ceramic
- Heat treating
- Instrument cabling
- Jet engines and test cells
- Kilns
- Laboratory and research
- Medical
- Nuclear reactors
- Power stations and steam generators
- Refineries and oil processing
- Rocket engines
- Semiconductor processing
- Turbines
- Vacuum furnaces

# Mineral Insulated Cable

## XACTPAK Cable

### Technical Data

#### Quality Control and Testing

To maintain quality and consistency, XACTPAK cable is manufactured under carefully controlled procedures and rigid standards of cleanliness. Quality checks are made at critical points throughout the manufacturing process.

Every coil of XACTPAK cable is thoroughly tested for continuity, insulation resistance, physical dimensions and physical appearance.

Each lot, or batch of XACTPAK, contains raw materials (sheath, insulation, wires) from one production lot which eliminates the need to calibrate every thermocouple cut from a coil because of poor homogeneity. Samples from each lot are calibrated in Watlow's modern calibration laboratory by highly skilled technicians. Unlike some manufacturers who calibrate at a few low temperature calibration points, Watlow calibrates throughout the range that matches the cable's capabilities.

#### Care, Handling and Fabrication of XACTPAK Cable

To maximize performance advantages made possible by XACTPAK cable's overall premium quality, the following instructions covering its storage, handling and further fabrication should be followed.

##### Storage

To prevent moisture from being absorbed by its hygroscopic mineral insulation, both ends of each length of XACTPAK cable are sealed at the factory. To further guard against moisture penetration, it is advisable to store XACTPAK material in a dry place.

##### Moisture

If XACTPAK cable is not adequately sealed, its insulation absorbs moisture. This lowers its electrical resistance and may prove to be troublesome in subsequent welding. Minor moisture penetration can be remedied by using a blow torch to heat the sheath. Apply the flame six to seven inches from the open end and slowly work the flame to and over the end. Reseal the end after it has cooled to about 180°F (82°C). Deep moisture penetration is unlikely, but if it occurs, the material may be baked at approximately 250°F (121°C) for 24 hours to increase its insulation resistance. If baking does not return the insulation resistance to acceptable levels, the material should be discarded.

##### Cutting

When pieces are cut from a length of XACTPAK cable, the exposed ends should immediately be squared and sealed. Squaring and sealing guards against possible contamination and removes any loosened insulation or distorted wire caused by cutting. A light pressure sanding with a 180-grit belt is the easiest method for rough squaring of 0.040 in. (1.016 mm) or larger diameter XACTPAK cable. Applying hard pressure against the sanding belt causes excessive heat build-up which may "smear" the soft metal over the insulation. After sanding, a clean fine toothed file should be used to dress the squared ends. Each exposed end should be sealed to prevent moisture absorption.

Inexperienced personnel may find 0.032 in. (0.813 mm) or smaller diameter XACTPAK cable difficult to handle and will probably prefer to have all cutting, stripping and fabricating done at the Watlow factory.

##### Insulation Resistance

XACTPAK mineral insulated, metal-sheathed cable should have a minimum room temperature insulation resistance of 100 megohms when tested at 50VDC for both wires to sheath and wire to wire.

All ceramics used in XACTPAK cable decrease in resistance as temperature increases.

##### Shipping and Packaging

XACTPAK cable is stocked in random lengths from 20 feet (6 m) to the "Maximum Stock Lengths" listed in the tables on the following pages. We reserve the right to supply random lengths of our choice unless specific cut lengths are specified on the order.

Upon request, XACTPAK cable can be furnished in other coil dimensions or shipped in straight form if necessary. Longer lengths are available for special order.

##### Stripping

A hand stripping tool will readily remove the sheath from 0.020 through 0.125 in. (3 mm) diameter XACTPAK cable. However, due to difficulty in working with 0.032 in. (0.8 mm) or smaller diameter material, it is recommended that small diameter material be ordered as factory stripped. Material larger than 0.125 in. (3.2 mm) diameter can be stripped on a lathe with a suitable tool bit or lathe-mounted stripping tool. It is also possible to strip larger sizes of XACTPAK cable by using a hacksaw to make a ring cut through the sheath at the desired distance from the end. Hammering the severed portion of sheath at several places will break up the insulation allowing the sheath to be slipped off.

# Mineral Insulated Cable

## XACTPAK Cable

### Technical Data (Continued)

After stripping, the exposed conductors should be sandblasted or cleaned with emery cloth. The exposed ends should be resealed immediately after completion of the stripping operation.

#### Forming

Because XACTPAK cable's sheath is dead soft and bright annealed, it can be formed and shaped to most contours without risk of cracking. As a guideline, the sheath can be formed around a mandrel twice the sheath diameter without damage. Therefore, 0.125 in. (3.2 mm) diameter XACTPAK cable can be wound around a 0.250 in. (6 mm) diameter mandrel.

#### Welding

Due to the delicate nature of the process and to avoid possible contamination, it is recommended that fabrication of "hot" or "measuring" junctions be done at the factory. If attempted in the field, a welding rod made from the same material as the sheath should be used with inert gas. Flux should not be used as it will contaminate the insulation.

Other weldments, such as to a vessel or pipe, should be made in an inert atmosphere to prevent oxidation of the sheath. When working with XACTPAK cable of 0.040 in. (1.0 mm) outside diameter or less, extreme caution should be used not to burn through the sheath.

## How to Select XACTPAK Cable to Suit Your Requirements

Watlow's mineral insulated metal-sheathed cable section has been designed for ease of use so that the right cable is chosen for each application. The following items must be considered when selecting XACTPAK mineral insulated metal-sheathed cable:

### 1. Sheath Material

The sheath serves to isolate and protect the wires and insulation from contamination and mechanical damage. There is no single sheath material that is appropriate for all conditions, so Watlow offers a wide variety. Temperature, strength, corrosiveness, service life and cost must be considered when selecting a sheath material.

### 2. Calibration

Watlow stocks most ANSI/ASTM recognized thermocouple types. Watlow also manufactures cable with other wire alloys such as nickel, copper, nickel clad copper, 304 stainless steel, alloy 600 and virtually any malleable metal.

### 3. Insulation Material

Insulation separates conductors from each other and the outer sheath. When selecting an insulation, temperature rating, environment and cost must be considered.

### 4. Physical Characteristics

Diameter of the sheath and the wall thickness will directly affect the following:

- Time response
- Service life
- Flexibility
- Pressure rating
- Strength

### 5. Specify Coil Lengths

Random—the factory selects 20 ft (6 m) minimum.  
Special—specify lengths and tolerance. Cut to length charges and minimum order quantities may apply.

# Mineral Insulated Cable

## XACTPAK Cable

### Sheath Material

The following information is designed to be used as a guide and may not be correct for every application. If in doubt, consult with a Watlow sales engineer or contact the factory.

#### Part Number

①	② ③	④	⑤	⑥ ⑦	⑧ ⑨ ⑩	⑪ ⑫
	Sheath Material Code Below	Calibration	Insulation	Sheath O.D.	Variation	Limits of Error
4						

#### Alloy 600

**01**—Maximum temperature: 2150°F (1175°C). Most widely used thermocouple sheath material. Good high temperature strength, corrosion resistance, resistance to chloride ion stress corrosion cracking and oxidation resistance to high temperatures. Do not use in sulfur bearing environments. Good for use in nitriding environments.

#### 304 SS

**02**—Maximum temperature: 1650°F (900°C). Most widely used low temperature sheath material. Extensively used in foodservice, beverage, chemical and other industries where corrosion resistance is required. Subject to damaging carbide precipitation in 900 to 1600°F (480 to 870°C) range. Lowest cost corrosion resistant sheath material available.

#### 316 SS

**04**—Maximum temperature: 1650°F (900°C). Best corrosion resistance of the austenitic stainless steel grades. Widely used in the foodservice and chemical industry. Subject to damaging carbide precipitation in 900 to 1600°F (482 to 870°C) range.

#### Hastelloy® X

**18**—Maximum temperature: 2200°F (1205°C). Widely used in aerospace applications. Resistant to oxidizing, reducing and neutral atmospheric conditions. Excellent high temperature strength along with superior oxidation resistance. Resistant to stress corrosion cracking in petrochemical applications.

#### Inconel® 625

**25**—Maximum temperature: 1800°F (980°C). Used in many aerospace applications. Excellent high temperature strength. Excellent resistance to pitting and crevice corrosion. Unaffected by radiation embrittlement.

#### Haynes® Alloy 230

**32**—Maximum temperature: 2150°F (1177°C). This alloy offers excellent high temperature strength, oxidation resistance and long term thermal stability. Used in aerospace applications, chemical process industries and high temperature industrial heating applications. This alloy is recommended for use in nitriding environments.

# Mineral Insulated Cable

## XACTPAK Cable

### Calibration

#### Part Number

①	② ③	④	⑤	⑥ ⑦	⑧ ⑨ ⑩	⑪ ⑫
	Sheath Material	Calibration Code Below	Insulation	Sheath O.D.	Variation	Limits of Error
4						

#### ASTM Type J

**1**—Type J's positive leg (JP) is iron. Its negative leg (JN) is approximately 45 percent nickel-55 percent copper. When protected by compacted mineral insulation and outer sheath, Type J is usable from 32 to 1500°F (0 to 815°C). Type J is not susceptible to short range ordering in the 600 to 1100°F (315 to 593°C) temperature range, (+2 to +4°F drift) which occurs with ASTM Type E and K. This low cost, stable thermocouple calibration is primarily used with 96 percent pure magnesium oxide (MgO) insulation and stainless steel sheath.

#### ASTM Type K

**2**—Type K's positive leg (KP) is approximately 90 percent nickel-10 percent chromium. Its negative leg (KN) is approximately 95 percent nickel-two percent aluminum-two percent manganese-one percent silicon. When protected by compacted mineral insulation and outer sheath, Type K is usable from 32 to 2300°F (0 to 1260°C). If the application is 600 to 1100°F (315 to 593°C), we recommend Type J or N due to short range ordering that can cause drift of +2 to +4°F (+1.5 to +2°C) in a few hours time. Type K is relatively stable during radiation transmission in nuclear environments. For applications below 32°F (0°C), special alloy selections are usually required.

#### ASTM Type T

**3**—Type T's positive leg (TP) is pure copper. Its negative leg (TN) is approximately 45 percent nickel-55 percent copper. When protected by compacted mineral insulation and outer sheath, Type T is usable from 32 to 660°F (0 to 350°C) and very stable in cryogenic and low temperature applications. For applications below 32°F (0°C) special alloy selections may be required.

#### ASTM Type E

**4**—Type E's positive leg (EP) is approximately 90 percent nickel-10 percent chromium. Its negative leg (EN) is approximately 45 percent nickel-55 percent copper. When protected by compacted mineral insulation and outer sheath, Type E is usable from 32 to 1650°F (0 to 900°C) and has the highest electromotive force (EMF) output per degree of all ASTM types. If the application temperature is 600 to 1100°F (315 to 593°C) Type J or N is recommended due to short range ordering which can cause drift of +1 to +3°F in a few hours time. For applications below 32°F (0°C), special alloy selections may be required.

#### ASTM Type N

**8**—Type N's positive leg (nicosil) is approximately 14 percent chromium-1.4 percent silicon-84.6 nickel. Its negative leg (nisil) is approximately 4.4 percent silicon-95.6 percent nickel. When protected by compacted mineral insulation and outer sheath, it's usable from 32 to 2300°F (0 to 1260°C). Type N overcomes several problems inherent in Type K. Short range ordering, +2 to +4°F drift (+1.5 to +2°C), in the 600 to 1100°F (315 to 593°C) range is greatly reduced, and drift rate at high temperatures is considerably less. Type N is also more stable than Type K in nuclear environments.

#### Miscellaneous

**9**—Contact the factory.

# Mineral Insulated Cable

## XACTPAK Cable

### Insulation

#### Part Number

①	② ③	④	⑤	⑥ ⑦	⑧ ⑨ ⑩	⑪ ⑫
	Sheath Material	Calibration	Insulation Code Below	Sheath O.D.	Variation	Limits of Error
4						

#### High Purity Magnesium Oxide (MgO) 99.4 Percent Minimum Purity

**1**—Low impurity levels make this insulation very useful for all thermocouple calibrations up to 2500°F (1370°C). Above 2500°F (1371°C), Watlow recommends using hafnia oxide insulation because of MgO's low resistivity. This material meets the requirements established in ASTM E-235.

#### Magnesium Oxide (MgO) 96% Minimum Purity

**5**—This low cost insulation is similar to high purity MgO (1) except it should be used in applications below 2000°F (1095°C) due to impurity levels. This insulation should not be used with platinum or in nuclear applications.

# Mineral Insulated Cable

## XACTPAK Cable

### Sheath O.D.

#### Part Number

①	② ③	④	⑤	⑥ ⑦	⑧ ⑨ ⑩	⑪ ⑫
	Sheath Material	Calibration	Insulation	Sheath O.D. Code Below	Variation	Limits of Error
4						

Code	Sheath Diameter		Approximate Standard	Coil Weight lbs/100 ft	Average Response Time* Still Water (seconds)	
	Nominal	Tolerance			G-JCT	U-JCT
01	0.020 inch	+0.001, -0.0005	9 inch	0.08	<0.02	0.03
02	0.032 inch	+0.001, -0.0005	9 inch	0.20	0.02	0.07
03	0.040 inch	+0.001, -0.0005	9 inch	0.32	0.04	0.13
04	0.063 inch	±0.001	24 inch	0.74	0.22	0.40
07	0.125 inch	+0.002, -0.001	24 inch	3.00	0.50	1.10
08	0.188 inch	+0.002, -0.001	24 inch	6.65	1.00	2.30
11	0.250 inch	+0.003, -0.001	24 inch	11.65	2.20	4.10
13	0.375 inch	+0.003, -0.001	Straight or 40 inch coils	28.10	8.00	11.00
15	0.500 inch	+0.003, -0.001	Straight or 40 inch	47.00	15.00	20.00
51	0.5 mm	±0.02	23 cm	0.08	<0.02	0.03
52	1.0 mm	±0.02	23 cm	0.32	0.04	0.13
53	1.5 mm	±0.02	61 cm	0.65	<0.15	0.35
54	2.0 mm	±0.03	61 cm	1.13	0.25	0.55
55	3.0 mm	±0.03	61 cm	2.60	0.40	0.90
56	4.5 mm	±0.03	61 cm	6.00	0.95	2.00
57	6.0 mm	±0.05	61 cm	10.50	2.00	3.50

\* Note: First order response time 63.2 percent.

# Mineral Insulated Cable

## XACTPAK Cable

### Variations

#### Part Number

①	② ③	④	⑤	⑥ ⑦	⑧ ⑨ ⑩	⑪ ⑫
	Sheath Material	Calibration	Insulation	Sheath O.D.	Variation	Limits of Error
4					Code Below	

⑧ ⑨ ⑩	Variation
050 =	Dual adjacent
<b>Note:</b> Leave space blank for no variation	

### Limits of Error

#### Part Number

①	② ③	④	⑤	⑥ ⑦	⑧ ⑨ ⑩	⑪ ⑫
	Sheath Material	Calibration	Insulation	Sheath O.D.	Variation	Limits of Error
4						Code Below

⑪ ⑫	Limits of Error
Standard =	Leave blank
SP =	Special limits initial tolerance



# Mineral Insulated Cable

## XACTPAK Cable

### Sheath Material

Extended capabilities go beyond the functionality offered by catalog products. These offerings are only available for large quantity orders.

#### 310 SS

Maximum temperature: 2100°F (1150°C). Mechanical and corrosion resistance, similar to but better than 304 SS. Very good heat resistance. This alloy contains 25 percent chromium, 20 percent nickel. Not as ductile as 304 SS.

#### 347 SS

Maximum temperature: 1600°F (870°C). Similar to 304 SS except nickel niobium stabilized. This alloy is designed to overcome susceptibility to carbide precipitation in the 900 to 1600°F (480 to 870°C) range. Used in aerospace and chemical applications.

#### 446 SS

Maximum temperature: 2100°F (1150°C). Ferritic stainless steel with good resistance to sulfurous atmospheres at high temperatures. Good corrosion resistance to nitric acid, sulfuric acid and most alkalis. 27 percent chromium content gives this alloy the highest heat resistance of any ferritic stainless steel.

#### 321 SS

Maximum temperature: 1600°F (870°C). Similar to 304 SS except titanium stabilized for inter-granular corrosion. This alloy is designed to overcome susceptibility to carbon precipitation in the 900 to 1600°F (480 to 870°C) range. Used in aerospace and chemical applications.

#### Inconel® 601

Maximum temperature: 2150°F (1175°C) continuous, 2300°F (1260°C) intermittent. Similar to alloy 600 with the addition of aluminum for outstanding oxidation resistance. Designed for high temperature corrosion resistance. This material is good for use in carburizing environments and exhibits good creep rupture strength. Do not use in vacuum furnaces. Susceptible to intergranular attack by prolonged heating in 1000 to 1400°F (540 to 760°C) temperature range.

#### Haynes® Alloy HR-160

Maximum temperature: 2150°F (1175°C). Developed to provide superior sulfidation-resistance at high temperatures. This alloy exhibits good resistance to corrosion in some salt bath applications. Used in applications for sulfur furnaces, waste incinerators, coke burners, recuperators, cement kilns and high temperature furnaces.

#### Haynes® Alloy 718

Maximum temperature: 1300°F (700°C). A precipitation hardenable Inconel® alloy developed for corrosion resistance and excellent weldability. Application uses include gas turbine, aerospace, oil and gas production and nuclear.

---

### Insulation

#### Alumina Oxide (Al<sub>2</sub>O<sub>3</sub>) 99.6 Percent Minimum Purity

Although this material is comparable to MgO in its electrical properties and cost, it does not compact well and tends to “powder out.” This undesirable characteristic has made this insulation unpopular, therefore, cable with this type of insulation is available only as a special order.

#### Hafnia Oxide (HfO<sub>2</sub>)

Hafnia is used as a substitute for beryllia oxide (BeO) because of beryllia’s toxicity problem. The temperature limit of hafnia is 4530°F (2500°C), which is higher than BeO.

---

### Variations

- Triple element
- Heavy wall (approximately 20 percent heavier)

# Mineral Insulated Cable

## XACTPAK Cable

### Single Element Cable

Standard Limit Code Number	Special Limits of Error Code Number	Sheath Diameter	Sheath Material	Calibration	Nominal AWG Gauge	Nominal Wall Thickness (in.)	Max. Recommended Operating Temp °F (°C)
401-2101	401-2101-SP	0.020	Alloy 600	K	38	0.003	1600 (871)
401-2102	401-2102-SP	0.032	Alloy 600	K	34	0.004	1600 (871)
401-2103	401-2103-SP	0.040	Alloy 600	K	32	0.006	1600 (871)
402-2103	402-2103-SP	0.040	304 SS	K	32	0.006	1600 (871)
404-2103	404-2103-SP	0.040	316 SS	K	32	0.009	1600 (871)
401-2104	401-2104-SP	0.063	Alloy 600	K	28	0.009	2000 (1093)
N/A	401-2104-HT <sup>①</sup>	0.063	Alloy 600	K	28	0.009	2000 (1093)
404-2104	404-2104-SP	0.063	316 SS	K	28	0.012	1600 (871)
401-2107	401-2107-SP	0.125	Alloy 600	K	22	0.017	2150 (1177)
N/A	401-2107-HT <sup>①</sup>	0.125	Alloy 600	K	22	0.017	2150 (1177)
402-1507	402-1507-SP	0.125	304 SS	J	22	0.017	1500 (816)
402-2507	402-2507-SP	0.125	304 SS	K	22	0.017	1600 (871)
404-2507	404-2507-SP	0.125	316 SS	K	22	0.017	1600 (871)
401-2108	401-2108-SP	0.188	Alloy 600	K	19	0.025	2150 (1177)
402-1508	402-1508-SP	0.188	304 SS	J	19	0.025	1500 (816)
402-2508	402-2508-SP	0.188	304 SS	K	19	0.025	1600 (871)
404-2508	404-2508-SP	0.188	316 SS	K	19	0.025	1600 (871)
401-2111	401-2111-SP	0.250	Alloy 600	K	16	0.033	2150 (1177)
402-1511	402-1511-SP	0.250	304 SS	J	16	0.033	1500 (816)
402-2511	402-2511-SP	0.250	304 SS	K	16	0.033	1600 (871)
404-1511	404-1511-SP	0.250	316 SS	J	16	0.033	1500 (816)
404-2511	404-2511-SP	0.250	316 SS	K	16	0.033	1600 (871)
401-2113	401-2113-SP	0.375	Alloy 600	K	13	0.051	2150 (1177)

<sup>①</sup>This cable is designed for heat treat applications where stability and calibration per AMS2750 are required.

### Double Element Cable

Standard Limit Code Number	Special Limits of Error Code Number	Sheath Diameter	Sheath Material	Calibration	Nominal AWG Gauge	Nominal Wall Thickness (in.)	Max. Recommended Operating Temp °F (°C)
401-2104-050	401-2104-050-SP	0.063	Alloy 600	K	28	0.009	2000 (1093)
401-2107-050	401-2107-050-SP	0.125	Alloy 600	K	24	0.017	2000 (1093)
401-2108-050	401-2108-050-SP	0.188	Alloy 600	K	21	0.025	2150 (1177)
401-2111-050	401-2111-050-SP	0.250	Alloy 600	K	18	0.033	2150 (1177)

# Mineral Insulated Cable

## XACTPAK Cable

### Mineral Insulated Metal-Sheathed RTD Cable

This cable is used for making rugged resistance temperature detector (RTD) probes. Special spacing allows room for elements to be placed between conductors. Dimensions are shown below.

### Ordering Information

#### Part Number

①	② ③	④	⑤	⑥ ⑦	⑧ ⑨ ⑩
	Sheath Material	Wire	Wire Insulation	Sheath O.D.	Variation
4		9			

② ③	Sheath Material
01 =	Alloy 600
04 =	316 SS

④	Wire
9 =	Nickel 201

⑤	Wire Insulation
1 =	99.4% MgO
5 =	96% MgO

⑥ ⑦	Sheath O.D.
07 =	0.125 in. (3 mm) diameter
08 =	0.188 in. (4.8 mm) diameter
11 =	0.250 in. (6 mm) diameter

⑧ ⑨ ⑩	Variation
001 =	6-wire
003 =	4-wire

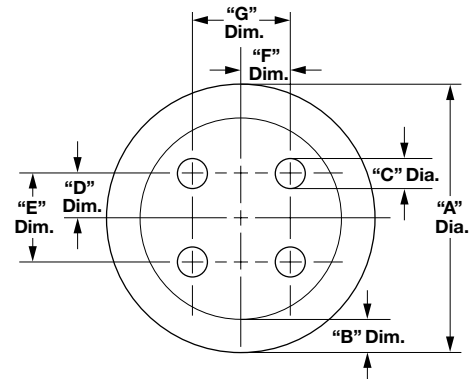

4 Conductor RTD MIMS Cable

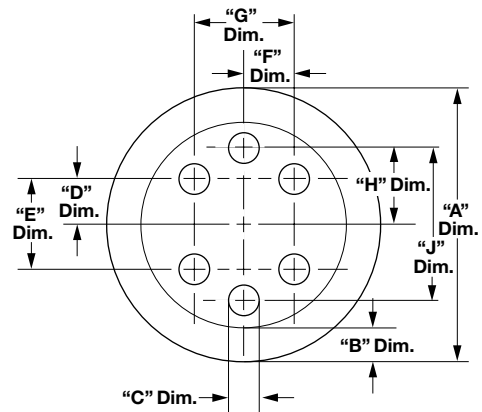

6 Conductor RTD MIMS Cable

A Diameter	B Wall Thickness	C Diameter	Spacing Nominal			
			D Dim.	E Dim.	F Dim.	G Dim.
0.125 +0.002 -0.001	0.015 ± 0.002	0.014 ± 0.002	0.022	0.045	0.025	0.050
0.188 +0.002 -0.001	0.023 ± 0.002	0.020 ± 0.002	0.034	0.068	0.037	0.074
0.250 +0.003 -0.001	0.030 ± 0.005	0.027 ± 0.003	0.045	0.090	0.050	0.100

A Dim.	B Dim.	C Dim.	D Dim.	E Dim.	F Dim.	G Dim.	H Dim.	J Dim.
0.125 +0.002 -0.001	0.015 ± 0.002	0.014 ± 0.002	0.022	0.045	0.025	0.050	0.034	0.068
0.188 +0.002 -0.001	0.023 ± 0.002	0.020 ± 0.002	0.034	0.068	0.037	0.074	0.052	0.104
0.250 +0.003 -0.001	0.030 ± 0.005	0.027 ± 0.003	0.045	0.090	0.050	0.100	0.068	0.137

# Mineral Insulated Cable

## XACTPAK Cable

Made-to-order  
Mineral Insulated (MI) Cable

### Ordering Information

#### Part Number

①	② ③	④	⑤	⑥ ⑦	⑧ ⑨ ⑩	⑪ ⑫
	Sheath Material	Calibration	Insulation	Sheath O.D.	Variation	Limits of Error
4						

② ③	Sheath Material
01 =	Alloy 600
02 =	304 SS
04 =	316 SS
18 =	Hastelloy® X
25 =	Inconel® 625
32 =	Haynes® Alloy 230

④	Calibration
1 =	J
2 =	K
3 =	T
4 =	E
8 =	N

⑤	Insulation
0 =	Unused
1 =	Magnesium oxide 99.4%
5 =	Magnesium oxide 96%

⑥ ⑦	Sheath O.D. in. (mm)
01 =	0.020 (0.6)
02 =	0.032 (0.8)
03 =	0.040 (1.0)
04 =	0.063 (1.6)
07 =	0.125 (3)
08 =	0.188 (4.8)
11 =	0.250 (6)
13 =	0.375 (9.5)
15 =	0.500 (13)

⑧ ⑨ ⑩	Variation
050 =	Dual adjacent — Example: 401-2107-050
<b>Note:</b> Leave space blank for no variation	

⑪ ⑫	Limits of Error
SP =	Special limits — Example: 401-2107-SP
<b>Note:</b> Leave space blank for standard	





# Watlow's Temperature, Process and Power Controller Offering

Watlow is a leading supplier of integrated multi-function, process and temperature controllers, power switching devices, agency-rated safety limits, operator interface terminals, process and event data loggers and recorders and accessories to reliably implement and control a complete thermal system.

Our expertise is backed by 80 years' experience designing, manufacturing and assisting customers with controller challenges across a broad range of applications. In industrial machines, processes and commercial equipment, Watlow products control parameters including temperature, over/under temperature limits, relative humidity, flow, position and pH, to name a few.

A variety of flexible, standard products are offered to address a multitude of control needs. Complementary accessories extend the controller solution seamlessly, and easy-to-understand user manuals and product documentation make it easy to quickly and effectively apply Watlow products. Our experienced and knowledgeable applications engineers will help you to find the ideal solution without added cost and time delay.

Watlow's solution development capabilities address all aspects of challenging control problems with just the right combination of proven techniques and innovation. While standard products are extremely flexible, some applications require accelerating a solution to the next level. Whether you use a standard product or a customized solution, our focus is to be your control expert.



CONTROLLERS

# EZ-ZONE® Connectivity Options via Ethernet

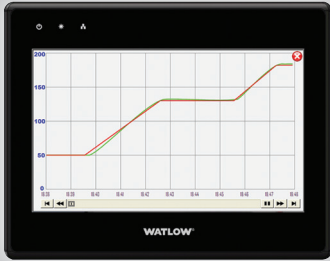

SILVER SERIES  
Operator Interface  
Terminal (OIT)

Ethernet  
Switch

To LAN →

Ethernet



EZ-ZONE® RUI  
Gateway



EZ-ZONE PM  
Family

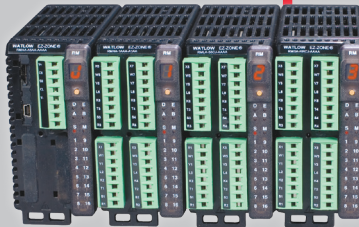

EZ-ZONE RM with  
Access Module



F4T With  
INTUITION



Third-Party  
Automation  
Products

EZ-ZONE Standard Bus



EZ-ZONE ST  
Family



EZ-ZONE PM  
Family



EZ-ZONE RM  
Family

— EtherNet/IP™ and Modbus® TCP  
- - - EZ-ZONE Standard Bus

*EtherNet/IP™*  
conformance tested



WATLOW

CONTROLLERS



# Table of Contents

## Controllers

<b>Product Selection Guide</b> .....	<b>198</b>
<b>Output Comparison Guide</b> .....	<b>207</b>
<b>Integrated Multi-Function</b> .....	<b>209</b>
F4T with INTUITION® .....	211
EZ-ZONE® RM .....	222
EZ-ZONE RMZ/RMF .....	240
EZ-ZONE ST .....	242
EZ-ZONE PM .....	249
EZ-ZONE PM Express .....	258
SERIES EHG® SL10.....	262
SERIES EHG .....	266
<b>Temperature and Process</b> .....	<b>269</b>
F4T with INTUITION.....	271
EZ-ZONE RM .....	272
EZ-ZONE RMZ/RMF .....	273
EZ-ZONE ST .....	274
SERIES F4 Ramping.....	275
SERIES F4 Process .....	281
EZ-ZONE PM .....	286
EZ-ZONE PM Express .....	287
SERIES CV .....	288
SERIES CF .....	291
SERIES EHG SL10.....	294
SERIES EHG .....	295
<b>Limits and Scanners</b> .....	<b>297</b>
F4T with INTUITION.....	299
EZ-ZONE RM High-Density Limit.....	300
EZ-ZONE RM High-Density Scanner .....	302
EZ-ZONE PM Limit .....	304
EZ-ZONE PM Express Limit.....	310
SERIES LV .....	314
SERIES LF.....	317
SERIES LS .....	320
TLM SERIES.....	322
<b>Power Switching Devices</b> .....	<b>325</b>
Comparison Guide .....	326
EZ-ZONE ST .....	327
DIN-A-MITE® A.....	328
DIN-A-MITE B.....	331
DIN-A-MITE C .....	334
DIN-A-MITE D.....	340

## Power Switching Devices (Con't)

POWER SERIES™ .....	343
QPAC .....	348
E-SAFE® II.....	353
SERIES CZR.....	356
Solid State Relays (SSR).....	359
<b>Operator Interfaces</b> .....	<b>363</b>
Silver Series EM.....	365
EZ-ZONE Remote User Interface (RUI) and Gateway.....	371
<b>Indicators</b> .....	<b>375</b>
EZ-ZONE PM .....	377
EZ-ZONE RUI and Gateway .....	378
SERIES TM.....	379
<b>Data Loggers</b> .....	<b>381</b>
F4T With INTUITION .....	383
EZ-ZONE RM System with Access Module .....	384
SpecView Human Machine Interface (HMI) Software .....	385
Silver Series EM.....	390
WATVIEW™ HMI Software .....	391
<b>Software</b> .....	<b>393</b>
COMPOSER® With INTUITION .....	395
EZ-ZONE Configurator.....	397
EZ-ZONE LabVIEW™ Driver .....	399
EZ-ZONE GSD Editor .....	400
EHG SL10 Software .....	401
SpecView HMI Software .....	402
EZwarePLUS .....	403
WATVIEW HMI Software .....	405
<b>Accessories</b> .....	<b>407</b>
EZ-ZONE RUI and Gateway .....	409
Serial Converters .....	410
Combined Branch Protection and Semiconductor Fusing.....	412
Semiconductor Fuses.....	414
Current Transformers.....	415
Panel Mount Adapter Plates .....	416
Arc Suppression and EMI Filters.....	416
Power Supplies .....	417
<b>Control Panels</b> .....	<b>421</b>
Control Panels .....	423

# Product Selection Guide







## Controllers

Product	Integrated Controller, PID, Power Output, Limit and Communications	Temperature and Process PID Controller	Multi-Loop Controller	Fiber Optic Temperature Sensing	Profile - Ramping Controller	On-Off Controller	Over/Under Limit, Alarms	Power Switching	Operator Interface	Indicator	Communication Converter - Gateway	EtherCAT® Comms	Data Logging	PC Software	Page
F4T with INTUITION	✓	✓	✓		✓	✓	✓	✓	✓	✓			✓		211
EZ-ZONE RM	✓	✓	✓		✓	✓	✓	✓					✓		222
EZ-ZONE RMZ		✓	✓	✓								✓			240
EZ-ZONE RMF		✓	✓	✓											240
EZ-ZONE PM	✓	✓	✓		✓	✓	✓	✓							249
EZ-ZONE ST	✓	✓			✓	✓	✓	✓							242
EZ-ZONE PM Express	✓	✓				✓	✓	✓							258
SERIES F4		✓	✓		✓	✓									275
SERIES EHG SL10	✓	✓				✓		✓							262
SERIES EHG		✓				✓		✓							266
SERIES CV, CF						✓									288
SERIES LV, LF, LS							✓								314
TLM							✓								322
DIN-A-MITE A								✓							328
DIN-A-MITE B								✓							331
DIN-A-MITE C								✓							334
DIN-A-MITE D								✓							340
POWER SERIES								✓							343
QPAC								✓							348
E-SAFE II								✓							353
SERIES CZR								✓							356
Solid State Relay (SSR)								✓							359
EZ-ZONE RUI and Gateway									✓	✓	✓				371
SERIES TM										✓					379
Silver Series EM									✓	✓			✓		365
COMPOSER														✓	395
SpecView													✓	✓	385
EZ-ZONE Configurator														✓	397
WATVIEW														✓	391

# Product Selection Guide

## Controllers



### Integrated Multi-Function

	Maximum Control Loops	Maximum Limit Loops	Maximum Monitor Channels	Fiber Optic Temperature Measurement	Profiling	Mounting	Maximum Output (A)	Ambient Operating Range		Communication Protocols	Dimensions
								°F	°C		
<b>F4T with INTUITION®</b>  See page 211	4	6	24	—	—	1/4 DIN front panel or flush mount	12A	0 to 122	-18 to 50	Standard bus, Modbus® TCP (Ethernet), Modbus® RTU, SCPI, USB host (2), USB device	Dimensions vary based on mounting style
<b>EZ-ZONE RM</b>  See page 222	152	192	256	—	✓	DIN-rail	15A	0 to 149	-18 to 65	Standard bus, EtherNet/IP™, DeviceNet™, PROFIBUS DP, Modbus® TCP, Modbus® RTU	Per module: 2.03 in. W x 4.41 in. H x 6.1 in. D (51.56 mm W x 44.45 mm H x 148 mm D)
<b>EZ-ZONE RMF</b>  See page 240	8	—	8	✓	—	DIN-rail	—	0 to 149	-18 to 65	Standard bus, EtherNet/IP™, DeviceNet™, PROFIBUS DP, Modbus® TCP, Modbus® RTU	Per module: 2.03 in. W x 4.41 in. H x 6.1 in. D (51.56 mm W x 44.45 mm H x 148 mm D)
<b>EZ-ZONE RMZ</b>  See page 240	48	—	—	✓	—	DIN-rail	—	0 to 149	-18 to 65	EtherCAT®, Standard bus, EtherNet/IP™, DeviceNet™, PROFIBUS DP, Modbus® TCP, Modbus® RTU	Per module: 2.03 in. W x 4.41 in. H x 6.1 in. D (51.56 mm W x 44.45 mm H x 148 mm D)
<b>EZ-ZONE ST</b>  See page 242	1	1	—	—	✓	DIN-rail	75A	0 to 158	-18 to 70	Standard bus, Modbus® RTU	With 25 or 40A heat sink: 7.43 in. H x 2.5 in. W x 6.14 in. D (188.6 mm H x 63.5 mm W x 156 mm D) (See details for size with other options)
<b>EZ-ZONE PM</b>  See page 249	2	1	1	—	✓	1/32, 1/16, 1/8, 1/4 DIN front panel	15A	0 to 149	-18 to 65	Standard bus, EtherNet/IP™, DeviceNet™, PROFIBUS DP, Modbus® TCP, Modbus® RTU	Dimensions vary with DIN size

# Product Selection Guide

## Controllers







### Integrated Multi-Function

	Maximum Control Loops	Maximum Limit Loops	Maximum Monitor Channels	Fiber Optic Temperature Measurement	Profiling	Mounting	Maximum Output (A)	Ambient Operating Range		Communication Protocols	Dimensions
								°F	°C		
<b>EZ-ZONE PM Express</b>  See page 258	1	1	—	—	—	1/32, 1/16 DIN front panel	15A	0 to 149	-18 to 65	Standard bus	Dimensions vary with DIN size
<b>SERIES EHG SL10</b>  See page 262	1	1	—	—	—	In-line, sub panel	10A	32 to 158	0 to 70	Modbus® RTU	3.496 in. W x 2.196 in. H x 1.907 in. D (88.80 mm W x 55.78 mm H x 48.07 mm D) without optional module
<b>SERIES EHG</b>  See page 266	1	—	—	—	—	In-line	10A	32 to 158	0 to 70	—	3.75 in. L x 1.85 in. D in. (95 mm L x 47 mm D)

# Product Selection Guide

## Controllers







### Temperature and Process

	Maximum Control Loops	Maximum Limit Loops	Maximum Monitor Channels	Fiber Optic Temperature Measurement	Profiling	Mounting	Maximum Output (A)	Ambient Operating Range		Communication Protocols	Dimensions
								°F	°C		
<b>F4T with INTUITION</b>  See page 271	4	6	24	—	—	1/4 DIN front panel or flush mount	12A	0 to 122	-18 to 50	Standard bus, Modbus® TCP (Ethernet), Modbus® RTU, SCPI, USB host (2), USB device	Dimensions vary based on mounting style
<b>EZ-ZONE RM</b>  See page 272	152	192	256	—	✓	DIN-rail	15A	0 to 149	-18 to 65	Standard bus, EtherNet/IP™, DeviceNet™, PROFIBUS DP, Modbus® TCP, Modbus® RTU	Per module: 2.03 in. W x 4.41 in. H x 6.1 in. D (51.56 mm W x 44.45 mm H x 148 mm D)
<b>EZ-ZONE RMF</b>  See page 273	8	—	8	✓	—	DIN-rail	—	0 to 149	-18 to 65	Standard bus, EtherNet/IP™, DeviceNet™, PROFIBUS DP, Modbus® TCP, Modbus® RTU	Per module: 2.03 in. W x 4.41 in. H x 6.1 in. D (51.56 mm W x 44.45 mm H x 148 mm D)
<b>EZ-ZONE RMZ</b>  See page 273	48	—	—	✓	—	DIN-rail	—	0 to 149	-18 to 65	EtherCAT®, Standard bus, EtherNet/IP™, DeviceNet™, PROFIBUS DP, Modbus® TCP, Modbus® RTU	Per module: 2.03 in. W x 4.41 in. H x 6.1 in. D (51.56 mm W x 44.45 mm H x 148 mm D)
<b>EZ-ZONE ST</b>  See page 274	1	1	—	—	✓	DIN-rail	75A	0 to 158	-18 to 70	Standard bus, Modbus® RTU	With 25 or 40A heat sink: 7.43 in. H x 2.5 in. W x 6.14 in. D (188.6 mm H x 63.5 mm W x 156 mm D) (See details for size with other options)
<b>SERIES F4 Ramping</b>  See page 275	2	—	1	—	✓	1/4 DIN front panel	0.5A	32 to 130	0 to 55	Modbus® RTU	3.93 in. H x 3.93 in. W x 3.85 in. D (99 mm H x 99 mm W x 97 mm D)
<b>SERIES F4 Process</b>  See page 281	1	—	2	—	—	1/4 DIN front panel	0.5A	32 to 149	0 to 65	Modbus® RTU	3.93 in. H x 3.93 in. W x 3.85 in. D (99 mm H x 99 mm W x 97 mm D)

# Product Selection Guide

## Controllers





### Temperature and Process

	Maximum Control Loops	Maximum Limit Loops	Maximum Monitor Channels	Fiber Optic Temperature Measurement	Profiling	Mounting	Maximum Output (A)	Ambient Operating Range		Communication Protocols	Dimensions
								°F	°C		
<b>EZ-ZONE PM</b>  See page 286	2	1	1	—	✓	1/32, 1/16, 1/8, 1/4 DIN front panel	15A	0 to 149	-18 to 65	Standard bus, EtherNet/IP™, DeviceNet™, PROFIBUS DP, Modbus® TCP, Modbus® RTU	Dimensions vary with DIN size
<b>EZ-ZONE PM Express</b>  See page 287	1	1	—	—	—	1/32, 1/16, 1/8, 1/4 DIN front panel	15A	0 to 149	-18 to 65	Standard bus	Dimensions vary with DIN size
<b>SERIES CV</b>  See page 288	1	—	—	—	—	DIN-rail, front panel, chassis	8A	32 to 158	0 to 70	—	Front panel mount: 2.85 in. W x 2.85 in. H x 2.04 in. D (72.4 mm W x 72.4 mm H x 51.7 mm D)
<b>SERIES CF</b>  See page 291	1	—	—	—	—	DIN-rail, front panel, chassis	8A	32 to 158	0 to 70	—	Front panel mount: 2.85 in. W x 2.85 in. H x 2.04 in. D (72.4 mm W x 72.4 mm H x 51.7 mm D)
<b>SERIES EHG SL10</b>  See page 294	1	1	—	—	—	In-line, sub panel	10A	32 to 158	0 to 70	Modbus® RTU	Without optional module: 3.496 in. W x 2.196 in. H x 1.907 in. D (88.80 mm W x 55.78 mm H x 48.07 mm D)
<b>SERIES EHG</b>  See page 295	1	—	—	—	—	—	10A	32 to 158	0 to 70	—	3.75 in. L x 1.85 in. D (95.25 mm L x 47 mm D)

# Product Selection Guide

## Controllers



### Limits and Scanners

	Maximum Limit Loops	Maximum Monitor Channels	Mounting	Maximum Output (A)	Ambient Operating Range		Communication Protocols	Dimensions
					°F	°C		
<b>F4T with INTUITION</b>  <a href="#">See page 299</a>	8	24	DIN-rail, flush mount	12A	0 to 122	-18 to 50	Standard bus, Modbus® TCP (Ethernet), Modbus® RTU, SCPI, USB host (2), USB device	Dimensions vary based on mounting style
<b>EZ-ZONE RM High-Density Limit</b>  <a href="#">See page 300</a>	192	192	DIN-rail	5A	0 to 149	-18 to 65	Standard bus, EtherNet/IP™, DeviceNet™, PROFIBUS DP, Modbus® TCP, Modbus® RTU	Per module: 2.03 in. W x 4.41 in. H x 6.1 in. D (51.56 mm W x 44.45 mm H x 148 mm D)
<b>EZ-ZONE RM High-Density Scanner</b>  <a href="#">See page 302</a>	—	256	DIN-rail	5A	0 to 149	-18 to 65	Standard bus, EtherNet/IP™, DeviceNet™, PROFIBUS DP, Modbus® TCP, Modbus® RTU	Per module: 2.03 in. W x 4.41 in. H x 6.1 in. D (51.56 mm W x 44.45 mm H x 148 mm D)
<b>EZ-ZONE PM Limit</b>  <a href="#">See page 304</a>	1	1	1/32, 1/16, 1/8, 1/4 DIN front panel	5A	0 to 149	-18 to 65	Standard bus, EtherNet/IP™, DeviceNet™, PROFIBUS DP, Modbus® TCP, Modbus® RTU	Dimensions vary with DIN size
<b>EZ-ZONE PM Express Limit</b>  <a href="#">See page 310</a>	1	1	1/32, 1/16 DIN front panel	5A	0 to 149	-18 to 65	Standard bus	Dimensions vary with DIN size

# Product Selection Guide

## Controllers

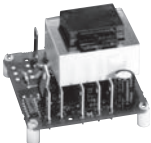
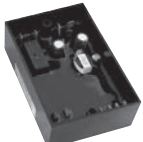
### Limits and Scanners







	Maximum Limit Loops	Maximum Monitor Channels	Mounting	Maximum Output (A)	Ambient Operating Range		Communication Protocols	Dimensions
					°F	°C		
<b>SERIES LV</b>  See page 314	1	1	DIN-rail, front panel, chassis	8A	32 to 158	0 to 70	—	Front panel mount: 2.85 in. W x 2.85 in. H x 2.04 in. D (72.4 mm W x 72.4 mm H x 51.7 mm D)
<b>SERIES LF</b>  See page 317	1	1	DIN-rail, front panel, chassis	8A	32 to 158	0 to 70	—	DIN-rail mount: 3.08 in. W x 4.42 in. H x 3.57 in. D (78.1 mm W x 122.3 mm H x 90.7 mm D)
<b>SERIES LS</b>  See page 320	1	1	Potted case with mounting screws	8A	32 to 158	0 to 70	—	3.5 in. W x 1.38 in. H x 2.76 in. D (88.9 mm W x 35.1 mm H x 70.1 mm D)
<b>TLM SERIES</b>  See page 322	8	8	DIN-rail, chassis	8A	32 to 140	0 to 60	—	DIN-rail mount: 9.30 in. W x 3.61 in. H x 2.62 in. D (236 mm W x 92 mm H x 68 mm D)



# Product Selection Guide

## Controllers



### Power Switching Devices

	Maximum Current	Phase Configurations	Inputs	Output Firing	Mounting	Other Features	Ambient Operating Range		Dimensions
							°F	°C	
 <p><b>EZ-ZONE ST</b></p> <p>See page 327</p>	75A	1	Driven by on-board controller	Zero-cross, phase angle	DIN-rail	—	0 to 158	-18 to 70	With 25 or 40A heat sink: 7.43 in. H x 2.5 in. W x 6.14 in. D (188.6 mm H x 63.5 mm W x 156 mm D) (See details for size with other options)
 <p><b>DIN-A-MITE A</b></p> <p>See page 328</p>	25A	1	VAC/VDC contactor, 4-20mA	Zero-cross	DIN-rail, back panel	—	0 to 176	-18 to 80	3.7 in. H x 1.8 in. W x 3.9 in. D (95 mm H x 45 mm W x 98 mm D)
 <p><b>DIN-A-MITE B</b></p> <p>See page 331</p>	40A	1 or 3	VAC/VDC contactor, 4-20mA, multi-zone input	Zero-cross	DIN-rail, back panel	Shorted SCR alarm	0 to 176	-18 to 80	3.7 in. H x 3.1 in. W x 4.9 in. D (95 mm H x 80 mm W x 124 mm D)
 <p><b>DIN-A-MITE C</b></p> <p>See page 334</p>	80A	1 or 3	VAC/VDC contactor, 4 to 20mA, multi-zone input, linear voltage, potentiometer	Zero-cross, phase angle	DIN-rail, through wall, back panel	Shorted SCR alarm, open heater alarm on zero-cross, current limit	0 to 176	-18 to 80	DIN-rail mount, without fan: 5.45 in. H x 3.25 in. W x 5.89 in. D (138 mm H x 83 mm W x 150 mm D)
 <p><b>DIN-A-MITE D</b></p> <p>See page 340</p>	100A	1	VAC/VDC contactor, 4-20mA	Zero-cross	DIN-rail, back panel	Shorted SCR alarm, load current monitor	0 to 176	-18 to 80	7.25 in. H x 2.5 in. W x 9.4 in. D (185 mm H x 65 mm W x 240 mm D)
 <p><b>POWER SERIES</b></p> <p>See page 343</p>	250A	1 or 3	0 to 20mA and 0-10VDC scalable, multi-zone input	Zero-cross, phase angle	Back panel	Load current monitor, soft start, heater bakeout, current limiting, shorted SCR, open heater alarm output Modbus® RTU com	32 to 149	0 to 65	14 in. H x 7.5 in. W x 7.9 in. D (354 mm H x 191 mm W x 200 mm D)







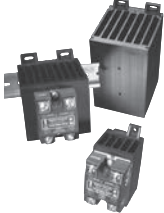

# Product Selection Guide

## Controllers



### Power Switching Devices

	Maximum Current	Phase Configurations	Inputs	Output Firing	Mounting	Other Features	Ambient Operating Range		Dimensions
							°F	°C	
<b>QPAC</b>  See page 348	1000A	1 or 3	VDC contactor, 4-20mA, linear voltage, potentiometer	Zero-cross, phase angle	Back panel	Open heater alarm, shorted SCR alarm, current limit	32 to 122	0 to 50	Q32 style C: 13 in. H x 13.7 in. W x 10.25 in. D (330 mm H x 350 mm W x 260 mm D) Q32 style E: 33 in. H x 21 in. W x 13.3 in. D (840 mm H x 535 mm W x 340 mm D)
<b>E-SAFE II</b>  See page 353	35A	1, 2 or 3	VAC/VDC contactor	Zero-cross	Back panel	—	32 to 158	0 to 70	3.82 in. H x 5.54 in. W x 1.85 in. D (97.03 mm H x 140.72 mm W x 46.99 mm D)
<b>SERIES CZR</b>  See page 356	42A	1	VAC/VDC contactor	Zero-cross	DIN-rail, back panel	—	176 max.	80 max.	18A models: 3.95 in. H x 0.89 in. W x 3.9 in. D (100 mm H x 22.6 mm W x 99 mm D) 24 to 42A models: 3.95 in. H x 1.75 in. W x 4.3 in. D (100 mm H x 45 mm W x 109 mm D)
<b>Solid State Relays (SSR)</b>  See page 359	75A	1	VAC/VDC contactor	Zero-cross, random fire	Back panel	Shorted SSR alarm, 20A DC output, 4 to 20 mAdc variable time base firing	-40 to 185	-40 to 85	Without heat sink: 2.25 in. H x 1.75 in. W x 0.9 in. D (57.2 mm H x 44.5 mm W x 23 mm D)

# Output Comparison Guide

I want to switch... I want to control...	Controller Output	Output Life
<ul style="list-style-type: none"> <li>DC input solid state relay (SSR)</li> <li>PLC-dc input</li> <li>Low voltage panel lamp</li> </ul>	Switched dc, open collector	
<ul style="list-style-type: none"> <li>Resistive 120 or 240VAC heater at less than 15A</li> </ul>	NO-ARC 15A power control	
<ul style="list-style-type: none"> <li>AC input SSR</li> <li>AC input solid state contactor</li> <li>High impedance load, typ. <math>\geq 5k\Omega</math></li> <li>Piezoelectric buzzer</li> <li>Indicator lamps</li> </ul>	Solid state relay, Form A	
<ul style="list-style-type: none"> <li>Solenoid coil/valve</li> <li>Mercury displacement relay (MDR)</li> <li>Electromechanical relay</li> <li>General purpose contactor</li> </ul>	Solid state relay, Form A with external contact suppression	
<ul style="list-style-type: none"> <li>Various devices in on-off mode with contact suppression</li> </ul>	Electromechanical relay, Form A	
<ul style="list-style-type: none"> <li>Various high impedance or inductive devices in on-off mode with coils suppressed</li> <li>Indicator lamps</li> <li>Small heaters</li> <li>AC input solid state contactor</li> </ul>	Electromechanical relay, Form A or C	
<ul style="list-style-type: none"> <li>A safety limit circuit with contactor, electromechanical relay or MDR</li> </ul>	Electromechanical relay, Form A with external contact suppression	N/A
<ul style="list-style-type: none"> <li>Various devices in on-off mode</li> <li>Solenoid coil/valve</li> <li>MDR</li> <li>Electromechanical relay</li> <li>General purpose contactor</li> <li>Pilot duty relays</li> </ul>	Electromechanical relay, Form C with external contact suppression	
<ul style="list-style-type: none"> <li>Phase-angle or burst fire SCRs</li> <li>0-20mA(dc), 4-20mA(dc), 0-5VDC, 1-5VDC or 0-10VDC valve positioner</li> <li>Inner loop's set point for cascading controllers</li> <li>Other instruments with process inputs</li> </ul>	Universal process	

## Retransmit/Alarms

I want to switch... I want to control...	Controller Output	Output Life
<ul style="list-style-type: none"> <li>Multiple devices, impedance dependent</li> <li>Chart recorder</li> <li>Master-remote (slave) system</li> <li>Data logging device</li> </ul>	Universal process	
<ul style="list-style-type: none"> <li>Various devices in on-off mode</li> </ul>	Electromechanical relay, Form A or C	

 **Best Life**

 **Better Life**

 **Good Life**



# Integrated Multi-Function

Product	Control/ Limit Loops	Mounting	Fiber Optic Temp. Measure- ment	Profiling	Maximum Output	Communication Protocols	Page
<b>F4T with INTUITION®</b>	4/6	DIN-rail, Flush mount	–	✓	12A	Standard bus, Modbus® TCP (Ethernet), Modbus® RTU, SCPI, USB Host (2), USB device	<b>211</b>
<b>EZ-ZONE® RM</b>	152/192	DIN-rail	–	✓	15A	Standard bus, EtherNet/IP™, DeviceNet™, PROFIBUS DP, Modbus® TCP, Modbus® RTU	<b>222</b>
<b>EZ-ZONE RMF</b>	8/0	DIN-rail	✓	–	–	Standard bus, EtherNet/IP™, DeviceNet™, PROFIBUS DP, Modbus® TCP, Modbus® RTU	<b>240</b>
<b>EZ-ZONE RMZ</b>	48/0	DIN-rail	✓	–	–	EtherCAT®, Standard bus, EtherNet/IP™, DeviceNet™, PROFIBUS DP, Modbus® TCP, Modbus® RTU	<b>240</b>
<b>EZ-ZONE ST</b>	1/1	DIN-rail	–	✓	75A	Standard bus, Modbus® RTU	<b>242</b>
<b>EZ-ZONE PM</b>	2/1	1/32, 1/16, 1/8, 1/4 DIN front panel	–	✓	15A	Standard bus, EtherNet/IP™, DeviceNet™, PROFIBUS DP, Modbus® TCP, Modbus® RTU	<b>249</b>
<b>EZ-ZONE PM Express</b>	1/1	1/32, 1/16, 1/8, 1/4 DIN front panel	–	–	15A	Standard bus	<b>258</b>
<b>SERIES EHG® SL10</b>	1/1	In-line/Sub panel	–	–	10A	Modbus® RTU	<b>262</b>
<b>SERIES EHG</b>	1/0	In-line	–	–	10A	N/A	<b>266</b>

**Note:** The specifications in the table above are the best available values in each category. Not all combinations of these values are available in a single model number.

Integrated Multi-Function



# Integrated Multi-Function

## F4T with INTUITION®

The F4T with INTUITION® temperature process controller offers a wide range of field removable I/O modules for maximum design flexibility. Configurations can be custom tailored to meet the scaling needs of a tremendous range of equipment and applications while providing exactly the hardware types required for compatibility. The F4T controller also features a 4.3 inch, color, graphical touch panel. Combining power, flexibility and functionality, this new controller offers unmatched versatility, and its best-in-class ease of use could very well make user manuals a thing of the past.

### Features and Benefits

#### 4.3-inch, color touch panel with high-resolution, graphical user-interface

- Shortens learning curve and reduces operator errors
- Allows channels, profiles, alarms, inputs and outputs to be personalized with user defined names

#### Temperature PID, data logger, trend chart, over/under-temperature limit, power switching, math, logic, timers and counters combined into an integrated system

- Lowers ownership costs
- Eliminates the need for separate discrete components
- Reduces complexity
- Simplifies design, ordering and installation
- Saves money

#### Robust algorithms for temperature, cascade, altitude, humidity and compressor

- Improves process control
- Offers one to four channels of control
- Provides multiple PID sets
- Enables TRU-TUNE®+ adaptive control algorithm
- Offers 40 ramp and soak profiles with real-time clock and battery backup

#### COMPOSER® graphical configuration PC software

- Speeds up and simplifies commissioning
- Archives and documents controller setup
- Connects with controller easily via Ethernet

#### Many communications options available including Ethernet Modbus® TCP and SCPI and EIA-232/485 Modbus® RTU

- Offers two USB host ports and one device port
- Simplifies file transfers
- Connects easily



#### Modular design

- Adapts quickly to evolving requirements
- Offers numerous types of field pluggable modules for maximum flexibility and easiest compatibility
- Features scalable and modular firmware functions
- Delivers scalable input/output quantities from 1 to 36

#### Agency certifications include UL®, FM, CE, RoHS, W.E.E.E., NEMA 4X/IP65

- Ensures high quality and reliability
- Verifies performance in installations worldwide

#### SERIES F4S/F4D/F4P backward compatible

- Provides easy retrofit with minimum pain and disruption
- Ensures proper fit in existing SERIES F4 panel cutout

#### Off-the-shelf solution

- Provides cost-effective “make versus buy”
- Offers preconfigured touch-panel screens
- Assures quicker time to market

# Integrated Multi-Function

## F4T with INTUITION

### Key Features and Options

- 1 to 4 control loops with TRU-TUNE+ adaptive control algorithm for superior controllability
- 40 profiles for ramp and soak
- Ethernet Modbus® TCP connectivity
- Multiple high-speed USB host ports
- Over/under-temperature limits for safety shutdown
- Universal, thermistor and ac current measurement inputs
- Inputs and outputs expandable from 1 to 36
- SENSOR GUARD prevents unplanned process shutdowns and product loss by switching to a backup sensor if the primary sensor fails
- High current outputs for up to 10A heaters or other loads
- Programmable timers, counters, math and logic
- Temperature, cascade, altitude, relative humidity, compressor algorithms and Vaisala® humidity compensation
- Sequencer start-up and control
- Retransmit and remote set point
- USB configuration port
- Configuration settings can be stored and recalled
- Removable modules and connectors
- Front-panel mount and flush mounting options
- Right angle and front-screw terminal options
- UL® listed, CSA, CE, RoHS, W.E.E.E., FM

### Common Specifications

#### Line Voltage/Power

- Data retention upon power failure via nonvolatile memory

#### Functional Operating Range

- Type J: -346 to 2192°F (-210 to 1200°C)
- Type K: -454 to 2500°F (-270 to 1371°C)
- Type T: -454 to 750°F (-270 to 400°C)
- Type E: -454 to 1832°F (-270 to 1000°C)
- Type N: -454 to 2372°F (-270 to 1300°C)
- Type C: 32 to 4200°F (0 to 2315°C)
- Type D: 32 to 4200°F (0 to 2315°C)
- Type F: 32 to 2449°F (0 to 1343°C)
- Type R: -58 to 3214°F (-50 to 1767°C)
- Type S: -58 to 3214°F (-50 to 1767°C)
- Type B: 32 to 3300°F (0 to 1816°C)
- RTD (DIN): -328 to 1472°F (-200 to 800°C)
- Process: -1999 to 9999 units

#### Calibration Accuracy

- Calibration accuracy and sensor conformity:  $\pm 0.1\%$  of span,  $\pm 1^\circ\text{C}$  at the calibrated ambient temperature and rated line voltage
  - Types R, S, B:  $\pm 0.2\%$
  - Type T below  $-50^\circ\text{C}$ :  $\pm 0.2\%$
- Calibration ambient temperature at  $77^\circ\text{F} \pm 5^\circ\text{F}$  ( $25^\circ\text{C} \pm 3^\circ\text{C}$ )

- Accuracy span:  $1000^\circ\text{F}$  ( $540^\circ\text{C}$ ) min.
- Temperature stability: Typical  $\pm 0.1^\circ\text{F}/^\circ\text{F}$  ( $\pm 0.1^\circ\text{C}/^\circ\text{C}$ ) rise in ambient max.

#### Configuration Diagnostics

- Indicates if modules present match the expected configuration settings

#### USB Device Port (Coming soon, consult factory for availability.)

- Version: USB 2.0 full-speed
- Connector: USB Mini Type B, 5 position
- Recognized as a mass storage device/serial communications
- Driver for Microsoft® Windows® 7 and Windows® 8

#### USB Host Port

- Total of 2 available
- Version: USB 2.0 hi-speed
- Connector: USB Type A, high-retention
- Flash drive must be FAT32 file system
- Max. current 0.5A/port

#### System Configuration Requirements

- F4T has 6 slots for flex modules (FM)
- EIA-232/485 Modbus® RTU flex module, if used, must occupy slot 6 location
- A maximum of two 10A SSR FM modules can be used in the F4T and each will require space for 2 slots. Valid in slots 1, 2, 4 or 5

#### Wiring Termination—Touch-Safe Terminals

- Right-angle and front-screw terminal blocks for input, output and power supply connections
- Input, output and power terminals: touch safe, removable, 12 to 30 AWG

### F4T Base Specifications

#### Line Voltage/Power

- High voltage option: 100 to 240VAC  $+10/-15\%$ , 50/60Hz  $\pm 5\%$
- Low voltage option: 24 to 28VAC/VDC  $+10/-15\%$ , 50/60Hz  $\pm 5\%$
- Power consumption: 23 W, 54VA

#### Environment

- NEMA 4X/IP65 front panel mount configuration only
- Operating temperature: 0 to  $122^\circ\text{F}$  ( $-18$  to  $50^\circ\text{C}$ )
- Storage temperature:  $-40$  to  $185^\circ\text{F}$  ( $-40$  to  $85^\circ\text{C}$ )
- Relative humidity: 0 to 90%, non-condensing

#### Agency Approvals

- UL®/EN 61010 Listed, File E185611 QUXX
- UL® 508 Reviewed
- CSA CC.C#14, File 158031
- FM Class 3545 (configurations with limit modules)
- RoHS by design, China RoHS Level 2, W.E.E.E.
- CE
- Windows® Hardware Certification



# Integrated Multi-Function

## F4T with INTUITION

### User Interface

- 4.3 inch TFT PCAP color graphic touch screen
- LED backlife >50K hours
- 4 keys; Home, Main Menu, Back, Help

### Control Loops

- 1 to 4 PID or ON-OFF control loops
- 0 to 6 Limit loops
- User-selectable action: heat, cool or heat/cool
- Auto-tune with TRU-TUNE+ adaptive control

### Control Loops and Over-temperature Limits

- Input sampling: 10Hz
- Output update: 10Hz

### Communications

- Ethernet Modbus® TCP
- Isolated communications

### Profile Ramp and Soak Option

- Profile engine affects 1 to 4 loops in sync
- 40 profiles with 50 steps per profile

### Real Time Clock with Battery Backup

- Accuracy (typical): +/-3ppm over -15 to 50°C
- Typical battery life: 10 years at 77°F (25°C)
- Field replaceable lithium battery

### Data Logging

- User selectable parameters: Up to a maximum of 128 active parameters depending on configuration
- Logging interval: Programmable increments between 0.1 seconds and 60 minutes if logging to internal memory. Logging directly to USB; 1.0 seconds to 60 minutes
- File types: .CSV for standard data logging or proprietary format for encrypted data log option
- Storage: 80MB internal memory or to USB memory stick
- File transfer: Internal memory to USB host port or to Ethernet Modbus® TCP
- Transfer options: On demand by user or user programmable based on time (hours) or immediately when a new data log file record is available or percent of memory used. Utilizes TFTP and Sambo protocols
- Record: Date and time stamped

### Number of Function Blocks by Ordering Option

Function Block	Basic	Set 1	Set 2
Alarm	6	8	14
Compare	None	4	16
Counter	None	4	16
Linearization	4	4	8
Logic	None	12	24
Math	None	12	24
Process Value	4	4	8
Special Output Function (including compressor)	None	2	4
Timer	None	6	16
Variable	4	12	24

### Compare

- Greater than, less than, equal, not equal, greater than or equal, less than or equal

### Counters

- Counts up or down, loads predetermined value on load signal

### Linearization

- Interpolated or stepped

### Logic

- And, nand, or, nor, equal, not equal, latch, flip-flop

### Math

- Average, process scale, switch over, deviation scale, differential (subtract), ratio (divide), add, multiply, absolute difference, minimum, maximum, square root, sample and hold, pressure-to-altitude and dew point

### Process Value

- Sensor backup, average, crossover, wet bulb-dry bulb, switch over, differential (subtract), ratio (divide), add, multiply, absolute difference, minimum, maximum, square root, altitude, Vaisala® relative humidity and pressure-to-altitude

### Special Output Function

- Compressor control (cool and/or dehumidify with single compressor), motorized valve, sequencer

### Timers

- On pulse, delay, one shot or retentive

### Variable

- User value for digital or analog variable

### Trending

- Consult factory

# Integrated Multi-Function

## F4T with INTUITION

### Panel Mount Dimensions

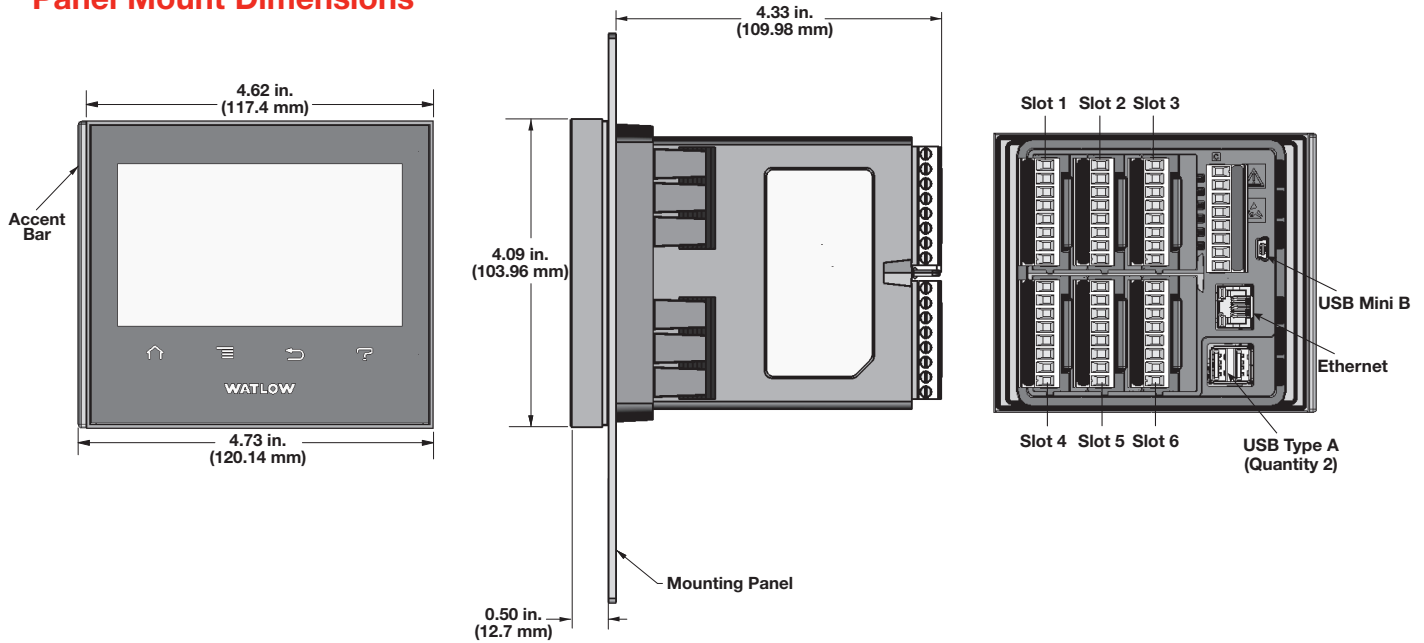

### Flush Mount Dimensions

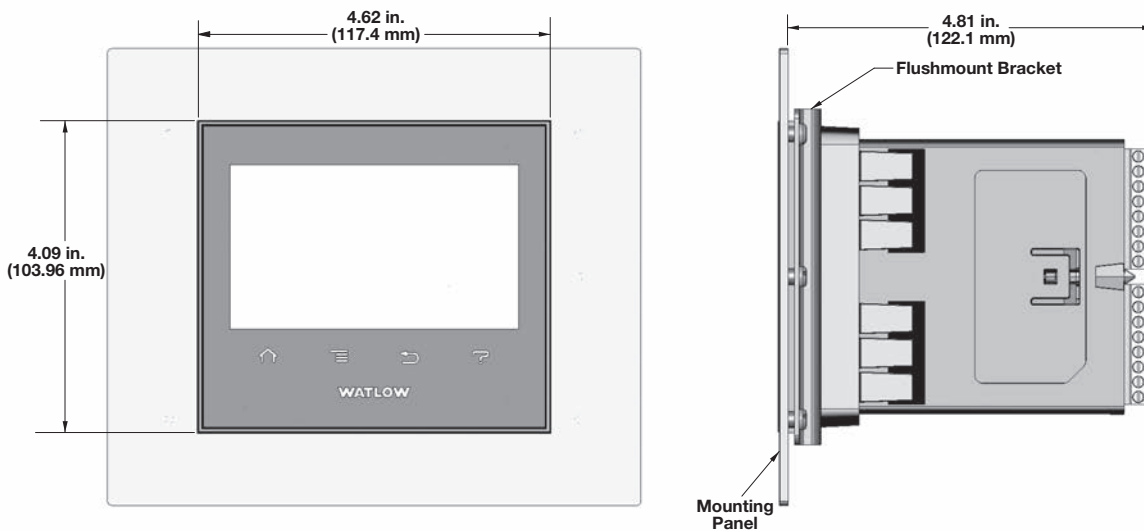

# Integrated Multi-Function

## F4T with INTUITION

### F4T Base Ordering Information

Base includes: 4.3 inch color graphical touch panel, 2 USB host, USB configuration port, standard bus, Ethernet Modbus<sup>®</sup> TCP. SCPI protocol and backwards compatible Modbus<sup>®</sup> for select key SERIES F4D/P/S parameters.

#### Part Number

① ②	③	④	⑤	⑥	⑦	⑧ ⑨	⑩ ⑪	⑫	⑬ ⑭ ⑮
	Base Type	Application Type	Data Logging	Power Supply Connector & Voltage, Logo	Profiles & Function Blocks	Future Options	Documentation, Accent Bar, Replacement Connector & Custom	Control Algorithms	Populated Flex Modules
F4	T					AA			

③ Base Type	
T =	Touch screen

④ Application Type	
1 =	Standard
X =	Custom options, contact factory

⑤ Data Logging and Graphic Trend Charts	
A =	None
B =	Graphical trend chart
J =	Data logging
K =	Data logging with encrypted files
L =	Data logging and graphical trend chart
M =	Data logging with encrypted files and graphical trend chart

⑥ Power Supply Connector & Voltage, Logo			
	Power Supply	Power Supply Connector	Watlow Logo
1 =	100 to 240VAC	Right angle (standard)	Yes
2 =	100 to 240VAC	Right angle (standard)	No
3 =	100 to 240VAC	Front screw	Yes
4 =	100 to 240VAC	Front screw	No
5 =	24 to 28VAC or VDC	Right angle (standard)	Yes
6 =	24 to 28VAC or VDC	Right angle (standard)	No
7 =	24 to 28VAC or VDC	Front screw	Yes
8 =	24 to 28VAC or VDC	Front screw	No

⑦ Profiles & Function Blocks					
	Profiles		Function Blocks		
	None	40 Profiles, Battery Backup and Real-Time Clock	Basic Set	Set 1	Set 2
A =	X		X		
B =	X			X	
C =	X				X
D =		X	X		
E =		X		X	
F =		X			X

**Note:** Refer to page 213 "Number of Function Blocks by Ordering Option" for quantities and types of functions blocks in each set in the F4T specification sheet on the web site.

⑧ ⑨ Future Options	
AA =	Future Options

⑩ ⑪ Documentation, Accent Bar, Replacement Connector & Custom					
	Documentation DVD / QSG	Decorated Brushed Aluminum Accent Bar			
		Gray	Blue	Red	None
1A =	Yes	X			
1B =	Yes		X		
1C =	Yes			X	
1D =	Yes				X
1E =	No	X			
1F =	No		X		
1G =	No			X	
1H =	No				X
1J =	Replacement connectors only - for the model number entered				
XX =	Contact factory, other custom-firmware, preset parameters, locked code, logo				

⑫ Control Algorithms		
	Control Loop	Cascade Loop
1 =	1	0
2 =	2	0
3 =	3	0
4 =	4	0
5 =	0	0
6 =	0	1
7 =	1	1
8 =	2	1
9 =	3	1
A =	0	2
B =	1	2
C =	2	2

**Note:** Each control loop algorithm requires 1 universal or thermistor input from a flex module.

**Note:** Each cascade loop algorithm requires 2 universal or thermistor inputs from flex modules.

⑬ ⑭ ⑮ Populated Flex Modules	
AAA =	No populated flex modules
XXX =	Contact factory - Populated flex modules
<b>Note:</b> If AAA is selected you will need to order Flex Modules (FM) next to account for input and output hardware.	

# Integrated Multi-Function

## F4T with INTUITION

### Flex Modules—High Density I/O Specifications

#### Four Universal Inputs (Control Loops, Auxiliary Input)

- Thermocouple: grounded or ungrounded sensors, greater than 20M $\Omega$  input impedance, 2k $\Omega$  source resistance max.
- RTD: 2-wire, platinum, 100 $\Omega$  and 1000 $\Omega$  at 32°F (0°C) calibration to DIN curve (0.00385 $\Omega$ /°C)
- Process: 0-20mA at 100 $\Omega$ , or 0-10VDC, 0-50mVDC at 20k $\Omega$  input impedance; scalable
- Potentiometer: 0 to 1,200 $\Omega$
- Inverse scaling

#### Four Thermistor Inputs (Control Loops, Auxiliary Input)

- 0 to 40k $\Omega$ , 0 to 20k $\Omega$ , 0 to 10k $\Omega$ , 0 to 5k $\Omega$
- 2.252k $\Omega$  and 10k $\Omega$  base at 77°F (25°C)
- Preprogrammed Steinhart-Hart coefficients for Alpha Techniques (A curve 2.252k and 10k, C curve 10k), BetaTHERM (2.2K3A, 10K3A and 10K4A) and YSI (004, 016 and 006)
- User-settable Steinhart-Hart coefficients for other thermistors

#### Three Universal Process/Retransmit Outputs

- Output range selectable
- 0 to 10VDC  $\pm$ 15mV into a min. 4,000 $\Omega$  load with 2.5mV nominal resolution
- 0 to 20mA  $\pm$ 30 $\mu$ A into max. 400 $\Omega$  load with 5 $\mu$ A nominal resolution
- Temperature stability 100ppm/°C

#### Three Mechanical Relays

- 2 Form C relays, 1 Form A relay. Form A relay shares common with 1 Form C relay
- Each relay is 5A, 24 to 240VAC or 30VDC max., resistive load, 100,000 cycles at rated load. Requires a min. load of 20mA at 24V, 125VA pilot duty 120/240VAC, 25VA at 24VAC

#### Four Mechanical Relays

- Form A, 5A ea., 24 to 240VAC or 30VDC max., resistive load, 100,000 cycles at rated load. Requires a min. load of 20mA at 24V, 125VA pilot duty

#### Two Solid State Relays

- Form A, 10A max. each SSRs combined at 24VAC min., 264VAC max., opto-isolated, without contact suppression, max. resistive load 10A per output at 240VAC, max. 20A per card at 122°F (50°C), max.

#### Four Solid State Relays

- Two pairs of SSRs, each pair shares a common
- Form A, 24VAC min., 264VAC max., opto-isolated, without contact suppression, resistive load 2A per output at 240VAC, max. See table for max. current per output

#### Quad 2A SSR Card Derating Curves

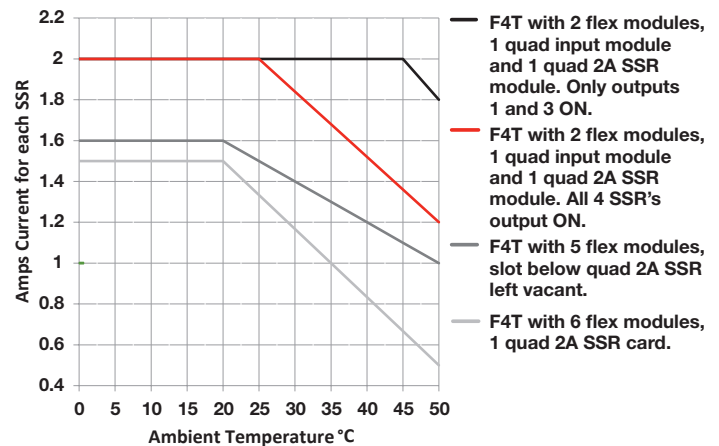

#### Six Digital I/O

- Each independently configurable as input or output
- Dry contact input: update rate 10Hz, min. open resistance 10k $\Omega$ , max. closed resistance 50 $\Omega$ , max. short circuit 13mA
- DC voltage input: update rate 10Hz, max. input 36V at 3mA, min. high state 3V at 0.25mA, max. low state 2V
- Switched dc output: max. 5VDC at 130mA, or 19-22VDC at 80mA; field selectable
- Open collector output: 32VDC at 1.5A max., 8A max. per 6 outputs combined

# Integrated Multi-Function

## F4T with INTUITION

### F4T Flex Module—High Density I/O Ordering Information

#### Part Number

<b>① ②</b>	<b>③</b>	<b>④</b>	<b>⑤</b>	<b>⑥ ⑦ ⑧</b>	<b>⑨</b>	<b>⑩</b>	<b>⑪ ⑫</b>
<b>FM</b>	<b>Module ID Type</b> H	<b>Future Option</b> A	<b>Input and Output Hardware</b> -	<b>Future Options</b> AAA	<b>Future Option</b> -	<b>Custom Options and Connectors</b> A	<b>Custom Options- Firmware, Overlay, Preset Parameters, Locked Code</b> AA

<b>③</b>	<b>Module ID Type</b>
H =	High Density I/O

<b>④</b>	<b>Future Option</b>
A =	Future Option

<b>⑤</b>	<b>Input and Output Hardware</b>
R =	4 universal inputs (T/C, RTD 2-wire, 0-10VDC, 0-20mA)
P =	4 thermistor inputs
C =	6 digital I/O
F =	3 universal process/retransmit outputs
B =	3 mechanical relay 5A, 2 Form C and 1 Form A (Form A shares a common with one Form C)
J =	4 mechanical relay 5A, Form A
K =	2 SSRs 10A <sup>①</sup>
L =	4 SSRs at 2A each. SSRs grouped in 2 pairs with each pair sharing a common

<sup>①</sup> **Notes:** Input and Output hardware option K: 2 SSR's 10A.  
The 2 SSR's 10A FM module requires 2 F4T slots. Valid slot locations are 1, 2, 4 or 5.  
The F4T can support a maximum of two total of the K option FM module types (4 total SSR, 10A).

<b>⑥ ⑦ ⑧</b>	<b>Future Options</b>
AAA =	Future Options

<b>⑨</b>	<b>Future Option</b>
A =	Future Option

<b>⑩</b>	<b>Custom Options and Connectors</b>
A =	Right angle screw connector (standard)
F =	Front screw connector

<b>⑪ ⑫</b>	<b>Custom Options - Firmware, Overlay, Preset Parameters, Locked Code</b>
AA =	Standard with quick start guide
AB =	Standard without quick start guide
AC =	Replacement connectors hardware only - for the entered model number
XX =	Custom

# Integrated Multi-Function

## F4T with INTUITION

### Flex Modules—Mixed and Limit I/O Specifications

#### Universal Input

- Thermocouple: grounded or ungrounded sensors, greater than 20M $\Omega$  input impedance, 2k $\Omega$  source resistance max.
- RTD: 2- or 3-wire, platinum, 100 $\Omega$  and 1000 $\Omega$  at 32°F (0°C) calibration to DIN curve (0.00385 $\Omega/\Omega/^\circ\text{C}$ )
- Process: 0-20mA at 100 $\Omega$ , or 0-10VDC, 0-50mVDC at 20k $\Omega$  input impedance; scalable
- Potentiometer: 0 to 1,200 $\Omega$
- Inverse scaling

#### Thermistor Input

- 0 to 40k $\Omega$ , 0 to 20k $\Omega$ , 0 to 10k $\Omega$ , 0 to 5k $\Omega$
- 2.252k $\Omega$  and 10k $\Omega$  base at 77°F (25°C)
- Preprogrammed Steinhart-Hart coefficients for Alpha Techniques (A curve 2.252k and 10k, C curve 10k), BetaTHERM (2.2K3A, 10K3A and 10K4A) and YSI (004, 016 and 006)
- User-settable Steinhart-Hart coefficients for other thermistors

#### Temperature Input

- Thermocouple: grounded or ungrounded sensors, greater than 20M $\Omega$  input impedance, 2k $\Omega$  source resistance max.
- RTD: 2-wire, platinum, 100 $\Omega$  and 1000 $\Omega$  at 32°F (0°C) calibration to DIN curve (0.00385 $\Omega/\Omega/^\circ\text{C}$ )

#### Digital Input

- Update rate 10Hz
- DC voltage: max. input 36V at 3mA, min. high state 3V at 0.25mA, max. low state 2V
- Dry contact input: min. open resistance 10k $\Omega$ , max. closed resistance 50 $\Omega$ , max. short circuit 13mA

#### Current Transformer Input

- Accepts 0-50mA signal (user programmable range)
- Displayed operating range and resolution can be scaled and are user programmable
- Current input range: 0 to 50mA ac, 100 $\Omega$  input impedance
- Response time: 1 second max., accuracy  $\pm 1\text{mA}$  typical
- Use with current transformer (Watlow part number: 16-0246)

#### Switched DC Output

- Max. 32VDC open circuit
- Max. current 30mA per single output
- Max. current 40mA per pair

#### Open Collector Output

- Max. 30VDC at 100mA

#### Solid State Relay (SSR) Output

- Form A, 1A at 50°F (10°C) to 0.5A at 149°F (65°C), 0.5A at 24VAC min., 264VAC max., opto-isolated, without contact suppression

#### Form A Electromechanical Relay Output

- 5A, 24 to 240VAC or 30VDC max., resistive load, 100,000 cycles at rated load, requires a min. load of 20mA at 24V, 125VA pilot duty

#### Form C Electromechanical Relay Output

- 5A, 24 to 240VAC or 30VDC max., resistive load, 100,000 cycles at rated load, requires a min. load of 20mA at 24V, 125VA pilot duty

#### NO-ARC Relay Output

- Form A, 12A at 122°F (50°C), 85 to 264VAC, no VDC, resistive load, 2 million cycles at rated load

#### Universal Process/Retransmit Output

- Range selectable
- 0 to 10VDC  $\pm 15\text{mV}$  into a min. 1,000 $\Omega$  load with 2.5mV nominal resolution
- 0 to 20mA  $\pm 30\mu\text{A}$  into max. 800 $\Omega$  load with 5 $\mu\text{A}$  nominal resolution
- Temperature stability 100ppm/ $^\circ\text{C}$

# Integrated Multi-Function

## F4T with INTUITION

### F4T Flex Module—Mixed I/O Ordering Information

#### Part Number

<b>① ②</b>	<b>③</b>	<b>④</b>	<b>⑤</b>	<b>⑥ ⑦</b>	<b>⑧</b>	<b>⑨</b>	<b>⑩</b>	<b>⑪ ⑫</b>
	Module ID Type	Future Option	Input Hardware	Output Hardware Options	Future Option	Future Option	Custom Options and Connectors	Custom Options- Firmware, Overlay, Preset Parameters, Locked Code
<b>FM</b>	<b>M</b>	<b>A</b>			<b>A</b>	<b>A</b>		

<b>③</b>	<b>Module ID Type</b>
M =	Mixed I/O

<b>④</b>	<b>Future Option</b>
A =	Future Option

<b>⑤</b>	<b>Input Hardware</b>
A =	None
U =	Universal input - T/C, RTD 2- or 3-wire, 0-10VDC, 0-20mA
T =	Thermistor input
C* =	Current transformer input

**\*Note:** If option C is ordered then the following options are NOT valid for Outputs 1 & 2: FA, FC, FJ and FK.

<b>⑥ ⑦</b>	<b>Output Hardware Options</b>	
	<b>Output 1</b>	<b>Output 2</b>
AA =	None	None
AJ =	None	Mechanical relay 5A, Form A
AK =	None	SSR Form A, 0.5A
CA =	Switched dc/open collector	None
CH =	Switched dc/open collector	NO-ARC 12A power control
CC =	Switched dc/open collector	Switched dc
CJ =	Switched dc/open collector	Mechanical relay 5A, Form A
CK =	Switched dc/open collector	SSR Form A, 0.5A
EA =	Mechanical relay 5A, Form C	None
EH =	Mechanical relay 5A, Form C	NO-ARC 12A power control
EC =	Mechanical relay 5A, Form C	Switched dc
EJ =	Mechanical relay 5A, Form C	Mechanical relay 5A, Form A
EK =	Mechanical relay 5A, Form C	SSR Form A, 0.5A
FA =	Universal process/retransmit	None
FC =	Universal process/retransmit	Switched dc
FJ =	Universal process/retransmit	Mechanical relay 5A, Form A
FK =	Universal process/retransmit	SSR Form A, 0.5A
KH =	SSR Form A, 0.5A	NO-ARC 12A power control
KK =	SSR Form A, 0.5A	SSR Form A, 0.5A

<b>⑧</b>	<b>Future Option</b>
A =	Future Option

<b>⑨</b>	<b>Future Option</b>
A =	Future Option

<b>⑩</b>	<b>Custom Options and Connectors</b>
A =	Right angle screw connector (standard)
F =	Front screw connector

<b>⑪ ⑫</b>	<b>Custom Options - Firmware, Overlay, Preset Parameters, Locked Code</b>
AA =	Standard with quick start guide
AB =	Standard without quick start guide
AC =	Replacement connectors hardware only - for the entered model number
XX =	Custom

# Integrated Multi-Function

## F4T with INTUITION

### F4T Flex Module—Limit Ordering Information

#### Part Number

① ②	③	④	⑤ ⑥ ⑦	⑧	⑨	⑩	⑪ ⑫
	Module ID Type	Future Option	Input and Output Hardware	Future Option	Future Option	Custom Options and Connectors	Custom Options- Firmware, Overlay, Preset Parameters, Locked Code
FM	L	A		A	A		

③ Module ID Type	
L =	Limit

④ Future Option	
A =	Future Option

#### ⑤ ⑥ ⑦ Input and Output Hardware Options

	Functions	Auxiliary Output Hardware	Limit Output Hardware	Auxiliary Input Hardware
LCJ =	Limit control with universal input	Switched dc/ open collector	Mechanical relay 5A, Form A	None
LEJ =	Limit control with universal input	Mechanical relay 5A, Form C	Mechanical relay 5A, Form A	None
LAJ =	Limit control with universal input	None	Mechanical relay 5A, Form A	None
MCJ =	Limit control with thermistor input	Switched dc/ open collector	Mechanical relay 5A, Form A	None
MEJ =	Limit control with thermistor input	Mechanical relay 5A, Form C	Mechanical relay 5A, Form A	None
MAJ =	Limit control with thermistor input	None	Mechanical relay 5A, Form A	None
YEB =	Limit control with temperature input	None	Mechanical relay 5A, Form C	Single digital input (limit reset)

**Notes:** Universal input = T/C, RTD 2- or 3-wire, 0-10VDC, 0-20mA  
 Temperature input = T/C and RTD 2-wire only

⑧ Future Option	
A =	Future Option

⑨ Future Option	
A =	Future Option

#### ⑩ Custom Options and Connectors

A =	Right angle screw connector (standard)
F =	Front screw connector

#### ⑪ ⑫ Custom Options - Firmware, Overlay, Preset Parameters, Locked Code

AA =	Standard with quick start guide
AB =	Standard without quick start guide
AC =	Replacement connectors hardware only - for the entered model number
XX =	Custom



# Integrated Multi-Function

## F4T with INTUITION

### F4T Flex Modules—Communication Ordering Information

#### Part Number

① ②	③	④	⑤	⑥ ⑦ ⑧	⑨	⑩	⑪ ⑫
FM	Module ID Type C	Future Option A	Comm. Option 2	Future Options AAA	Future Option A	Custom Options and Connectors	Custom Options- Firmware, Overlay, Preset Parameters, Locked Code

③	Module ID Type
C =	Communications

④	Future Option
A =	Future Option

⑤	Communications Option
2 =	Modbus® RTU 232/485
<b>Note:</b> EIA-232/485 Modbus® RTU flex module, if used, must occupy F4T slot 6 location.	

⑥ ⑦ ⑧	Future Options
AAA =	Future Options

⑨	Future Option
A =	Future Option

⑩	Custom Options and Connectors
A =	Right angle screw connector (standard)
F =	Front screw connector

⑪ ⑫	Custom Options - Firmware, Overlay, Preset Parameters, Locked Code
AA =	Standard with quick start guide
AB =	Standard without quick start guide
AC =	Replacement connectors hardware only - for the entered model number
XX =	Custom

### Accessories

Part Number	Description
0830-0870-0000	Protective screen cover (2 per pack)
0822-0705-0000	F4T 1/4 DIN mounting collar - thru front panel mount
0216-1285-0000	Flushmount - mounting adapter plate
0847-0400-0000	USB 2.0 to RJ45 Ethernet adapter
0238-1245-ALUM	Accent bar (brushed aluminum gray)
0238-1245-REDD	Accent bar (brushed aluminum red)
0238-1245-BLUE	Accent bar (brushed aluminum blue)
16-0246	Current transformer
0804-0147-0000	RC supression - Quencharc®
0601-0001-0000	Controller support tools (DVD)
0830-0808-0001 (CAPUSB-MB5)	Rubber plug USB mini
0830-0808-0002 (CAPUSB-A)	Rubber plug USB host
0830-0858-0000	Replacement battery
0822-0769-0000	Module slot plug (for vacant F4T slots without flex modules)

### Recommended Third-Party Components

Mfg.	Mfg. Part Number	Description	Web Site
Amphenol	USBF 21N SCC	USB - A receptacle with self closing cap	www.alliedelec.com
Amphenol	USBBF 21N SCC	USB - B receptacle with self closing cap	www.alliedelec.com
Amphenol	RJF 21N SCC	RJ45 receptacle with self closing cap	www.alliedelec.com
Molex	847290006	USB type A panel mount with 2 m cord	www.alliedelec.com
Molex	84700-0003	Dust cover	www.alliedelec.com

### Documentation

0600-0092-0000	Installation and Troubleshooting User's Guide
0600-0093-0000	Setup and Operations User Guide
0600-0094-0000	F4T Controller Quick Start Guide
0600-0095-0000	Communications Flex Modules Quick Start Guide
0600-0096-0000	High Density Flex Modules Quick Start Guide
0600-0097-0000	Mixed I/O Flex Modules Quick Start Guide

# Integrated Multi-Function

## EZ-ZONE® RM

The EZ-ZONE® RM controller simplifies thermal system management. The EZ-ZONE RM controller family is comprised of six module types: an integrated on-off or PID control, monitoring and over/under temperature limit module, a high-density on-off or PID control module, a high-density limit only module, an input/output (I/O) expansion module, a high-density monitor/scanner module and a data logging and field communications access module. A system is configured by connecting any combination of module types to address specific application needs. The EZ-ZONE RM is extremely flexible and scalable allowing mixing and matching of I/O to configure one to 152 control loops and up to 256 monitor points.

### Optional integrated controller functions can be combined or ordered in different quantities:

- PID control loops
- Over/under temperature limit control loops
- 10 and 15 ampere power output/heater driver options
- On-board data logging
- Current measurement input
- Sequencer start up and control function
- Programmable timer and counter functions
- Programmable math and logic options
- Multiple communication protocol options
- Mobile configuration with removable secure digital (SD) flash card

### Benefits of using an integrated controller solution:

- Reduces wiring time and termination complexity compared with connecting multiple discrete products
- Improves system reliability
- Reduces termination and installation cost
- Eliminates compatibility issues often encountered with using various discrete components and brands
- Reduces troubleshooting time and downtime costs because the system can specifically identify any problems with a sensor, controller, solid state relay (SSR) power output or heater load
- Complete thermal solution saves engineering time and labor costs while shortening project schedules

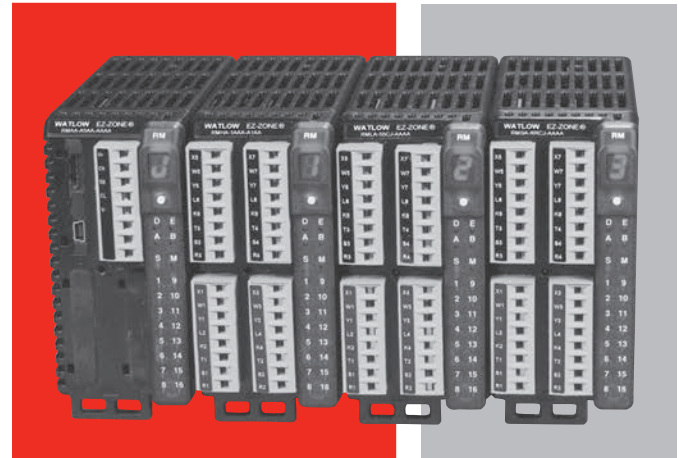

## Features and Benefits

### Multiple inputs; from one to 152 PID loops of control or monitor up to 256 analog inputs

- Mix and match I/O to fit any application; from one input with two outputs to 152 analog inputs with 152 outputs, or monitor up to as many as 256 analog inputs all in one system
- Reduces cost because only required loops are purchased
- Allows a common controller platform across many design applications as both loops and outputs can be ordered in single increments

### Advanced PID control algorithm

- Offers TRU-TUNE®+ adaptive control to provide tighter control for demanding applications
- Enables auto-tune for fast, efficient start-up

### Communication capabilities

- Provides a range of protocol options including universal serial bus (USB) device port, Modbus® RTU, EtherNet/IP™, Modbus® TCP, DeviceNet™ and PROFIBUS

### USB port

- Provides data log retrieval

### SPLIT-RAIL control

- Allows modules mounted in separate high-voltage and low-voltage cabinets to function as an integrated system
- Minimizes the length and cost of wire runs and improves system reliability by locating inputs closer to sensors and outputs closer to loads

### AUTO CLONE

- Reduces time and configuration complexity by automatically building a new module with the same parameter settings as the replaced module

### SENSOR GUARD

- Prevents unplanned process shutdowns and product loss by switching to a backup sensor if the primary sensor fails

# Integrated Multi-Function

## EZ-ZONE RM

### Additional Key Functions

- Configuration communication port (standard bus)
- Removable modules and connectors
- Ring lug and front-screw terminal options
- Profile ramp soak with 400 total steps
- Retransmit and remote set point input virtually inside controller eliminating costs for input/output hardware
- User configuration settings can be stored and recalled
- Thermistor input
- Elevated operating range of 0 to 149°F (-18 to 65°C)
- UL® listed, CSA, CE, RoHS, W.E.E.E., FM, SEMI F47-0200, Class 1, Div. 2 rating on selected models

### Common Specifications (Applies to all models)

#### Line Voltage/Power

- 20.4 to 30.8VAC/VDC, 50/60Hz ±5%
- Any external power supply used should comply with a Class 2 or SELV rating (see specific module specification listing for max. VA power consumption)
- Data retention upon power failure via non-volatile memory
- Compliant with Semi F47-0200, Figure R1-1 voltage sag requirements

#### Environment

- 0 to 149°F (-18 to 65°C) operating temperature
- -40 to 185°F (-40 to 85°C) storage temperature
- 0 to 90% RH, non-condensing

#### Functional Operating Range for RMC, RMH, RML and RMS

Type J: -346 to 2192°F (-210 to 1200°C)

Type K: -454 to 2500°F (-270 to 1371°C)

Type T: -454 to 750°F (-270 to 400°C)

Type E: -454 to 1832°F (-270 to 1000°C)

Type N: -454 to 2372°F (-270 to 1300°C)

Type C: 32 to 4200°F (0 to 2315°C)

Type D: 32 to 4200°F (0 to 2315°C)

Type F: 32 to 2449°F (0 to 1343°C)

Type R: -58 to 3214°F (-50 to 1767°C)

Type S: -58 to 3214°F (-50 to 1767°C)

Type B: 32 to 3300°F (0 to 1816°C)

RTD (DIN): -328 to 1472°F (-200 to 800°C)

Process: -1999 to 9999 units

### Agency Approvals

- UL®/EN 61010 Listed, File E185611, C-UL® C22.2 #61010ANSI/ISA 12.12.01-2007 Class 1, Div. 2 - Group A, B, C, D temperature code T4 (optional)
- UL® 1604 Class 1, Div. 2 (optional)
- EN 60529 IP20
- UL® 50, NEMA 4X, EN 60529 IP66; 1/16 DIN remote user interface (RUI)
- CSA 610110 CE
- RoHS by design, W.E.E.E.
- FM Class 3545 on limit control versions
- CE

### Serial Communications

- All modules ship with standard bus protocol for configuration and communication with all other EZ-ZONE products

### Implicit Messaging

Number of data members accessible through implicit messaging

Protocol	RM System	RMC	RMH	RML	RME	RMS	RMA
EtherNet/IP™	100	20	40	40	20	40	20
DeviceNet™	200	20	40	40	20	40	20

### User Interface

- Seven-segment LED, address/protocol indicator programmed via push button switch
- Communication activity, 2 LEDs
- Error condition of each loop, 4 LEDs
- Output status indication, 16 LEDs

### Maximum System Configuration

- One access module plus up to 16 additional control or expansion modules (any combination), up to 152 loops

### Mounting

- DIN-rail specification EN50022, 1.38 x 0.30 in. (35 x 7.5 mm)
- DIN-rail mounted or chassis mounted with customer supplied screws

### Wiring Termination—Touch-Safe Terminals

- Right angle and front screw type terminal blocks (slots A, B, D, E)
- Input, power and controller output terminals, touch safe, removable, 12 to 30 AWG

# Integrated Multi-Function

## EZ-ZONE RM

### Programmable Application Blocks

#### Compare

- Greater than, less than, equal, not equal, greater than or equal, less than or equal

#### Counters

- Counts up or down, loads predetermined value on the load signal. Output is active when the count value equals or exceeds predetermined target value

#### Linearization

- Interpolated or stepped relationship

#### Logic

- And, nand, or, nor, equal, not equal, latch, flip flop

#### Math

- Average, process scale, deviation scale, differential (subtraction), ratio (divide), add, multiply, absolute difference, min., max., square root, sample and hold, altitude and dew point

#### Process Value

- Sensor backup, average, crossover, wet/dry bulb, switch over, differential (subtraction), ratio (divide), add, multiply, absolute difference, min., max., square root, altitude, visala and dew point

#### Special Output Function

- Compressor – turns on-off compressor for one or two loops (cool and dehumidify with single compressor)
- Motorized valve – turns on-off motor open/closed outputs causing valve to represent desired power level
- Sequencer – turns on-off up to four outputs to distribute a single power across all outputs with linear and progressive load wearing

#### Timers

- On pulse – produces an output of fixed time on the active edge of timer run signal
- Delay – output is a delayed start of timer run and off at same time
- One shot – oven timer
- Retentive – measures timer run signal and output on when accumulated time exceeds target

#### Variable

- User value for digital or analog variable

### EZ-ZONE RM Family Comparison

	Control Module	High-Density Control Module	High-Density Limit Module	Expansion Module	High-Density Scanner Module
Number of modules per system	1 to 16	1 to 16	1 to 16	1 to 16	1 to 16
Number of PID loops per module	1 to 4	4, 8, 12 or 16	0	0	0
Number of limit loops per module	1 to 4	0	4, 8 or 12	0	0
Number of monitoring points per module	1 to 3	0	0	0	4, 8, 12 or 16
Mechanical relays per module	1 to 8	4 or 8	4, 6 or 8	4, 8 or 12	4 or 8
Digital I/O points per module	6	6 or 12	6 or 7	6, 12, 18 or 24	6, 7 or 12
Actions (events) per module	8	24	16	8	16
Alarms per module	8	24	16	8	16
Compare per module	4	24	16	8	24
Counters per module	4	24	16	8	24
Linearization per module	4	24	16	8	24
Logic per module	4	24	16	8	24
Math per module	8	24	16	8	24
Process value per module	1 to 4	4, 8, 12 or 16	4, 8 or 12	0	4, 8, 12 or 16
Special output function per module	4	0	0	4	0
Timers per module	4	24	16	8	24
Variable per module	8	24	16	8	24

# Integrated Multi-Function

## EZ-ZONE RM

### Dimensional Drawings

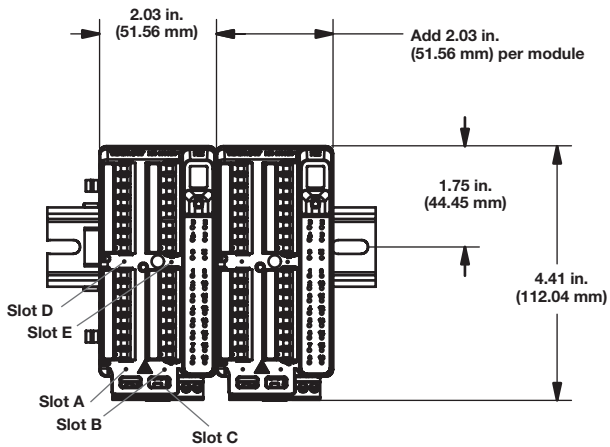

Connector Type	Module Depth in. (mm)
Standard (Right Angle)	5.8 (148)
Straight (Front Screw)	6.1 (155)
Ring Terminal	6.5 (166)

### Front-Screw Connectors

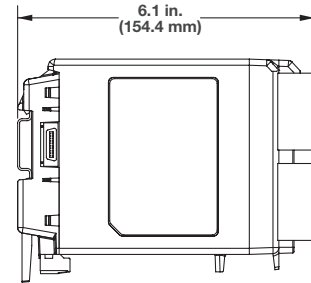

### Ring Terminal Connectors

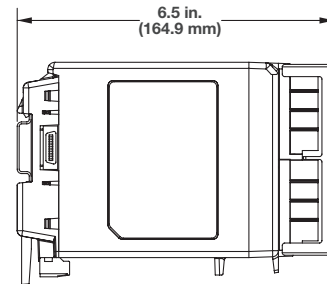

### Standard Connectors

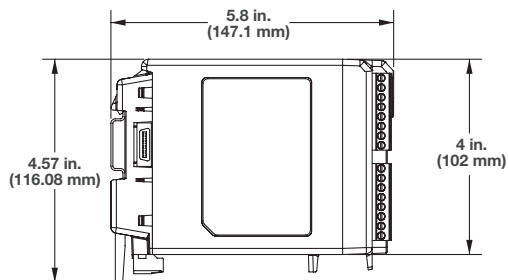

# Integrated Multi-Function

## EZ-ZONE RM

### Control Module Specifications (RMC)

(Select an RMC module for 1 to 4 loops of control.)

#### Line Voltage/Power

- Power consumption: 7 W, 14VA
- Any external power supply used should comply with a Class 2 or SELV rating

#### Controller

- User-selectable heat/cool, on-off, P, PI, PD, PID or alarm action, not valid for limit controllers

#### Process PID or Over-temperature Limit Mode Options

- Auto-tune with TRU-TUNE+ adaptive control
- Control sampling rates: input = 10Hz, output = 10Hz (non-divisional)

#### Isolated Serial Communications

- All modules ship with standard bus protocol for configuration and communication with all other EZ-ZONE controllers
- Optional EIA-485, Modbus® RTU

#### Profile Ramp and Soak (RMC only, not available with high-density controller)

- Profile engine affects one to four loops
- 25 profiles and 15 sub-routines, 400 steps total
- Option for battery backup and real time clock is via the access module

#### Calibration Accuracy

- $\pm 0.1\%$  of span,  $\pm 1^\circ\text{C}$ . See user manual for details.

#### Universal Input

- Thermocouple, grounded or ungrounded sensors
- $>20\text{M}\Omega$  input impedance
- Max. of  $2\text{k}\Omega$  source resistance
- RTD 2- or 3-wire, platinum,  $100\Omega$  and  $1000\Omega$  @  $32^\circ\text{F}$  ( $0^\circ\text{C}$ ) calibration to DIN curve ( $0.00385\Omega/\Omega/^\circ\text{C}$ )
- Process,  $0\text{-}20\text{mA}$  @  $100\Omega$ , or  $0\text{-}10\text{VDC}$  @  $20\text{k}\Omega$  input impedance; scalable,  $0\text{-}50\text{mV}$
- Potentiometer:  $0$  to  $1,200\Omega$
- Inverse scaling
- Current: input range is  $0$  to  $50\text{mA}$ ,  $100\Omega$  input impedance  
Response time:  $1$  second max., accuracy  $\pm 1\text{mA}$  typical

#### Thermistor Input

- $0$  to  $40\text{k}\Omega$ ,  $0$  to  $20\text{k}\Omega$ ,  $0$  to  $10\text{k}\Omega$ ,  $0$  to  $5\text{k}\Omega$
- $2.252\text{k}\Omega$  and  $10\text{k}\Omega$  base at  $77^\circ\text{F}$  ( $25^\circ\text{C}$ )

#### Digital Input

- Update rate  $10\text{Hz}$
- Max. input  $36\text{VDC}$  at  $3\text{mA}$
- Min. high state  $3\text{VDC}$  at  $0.25\text{mA}$
- Max. low state  $2\text{V}$

#### Dry Contact Input

- Update rate  $10\text{Hz}$
- Min. open resistance  $10\text{k}\Omega$ , max. closed resistance  $50\Omega$

#### Current Measurement Input

- Accepts  $0\text{-}50\text{mA}$  signal (user programmable range)
- Displayed operating range and resolution can be scaled and are user programmable

#### Output Hardware

- Switched dc:
  - Max.  $32\text{VDC}$  open circuit
  - Max. current  $30\text{mA}$  per single output
  - Max. current  $40\text{mA}$  per paired outputs (1 & 2, 3 & 4, 5 & 6, 7 & 8)
- Open collector:
  - Max.  $30\text{VDC}$  @  $100\text{mA}$
- 6 digital inputs/outputs:
  - Switched dc, max.  $20\text{VDC}$  @  $40\text{mA}$ ,  $12\text{VDC}$  @  $80\text{mA}$
  - Open collector, max.  $32\text{VDC}$  @  $1.5\text{A}$ , max.  $8\text{A}$  per 6 outputs combined
- SSR, Form A,  $1\text{A}$  at  $50^\circ\text{F}$  ( $10^\circ\text{C}$ ) to  $0.5\text{A}$  at  $149^\circ\text{F}$  ( $65^\circ\text{C}$ ),  $0.5\text{A}$  @  $24\text{VAC}$  min.,  $264\text{VAC}$  max., opto-isolated, without contact suppression
- Electromechanical relay, Form C,  $5\text{A}$ ,  $24$  to  $240\text{VAC}$  or  $30\text{VDC}$  max., resistive load,  $100,000$  cycles at rated load, requires a min. load of  $20\text{mA}$  at  $24\text{V}$ ,  $125\text{VA}$  pilot duty
- Electromechanical relay, Form A,  $5\text{A}$ ,  $24$  to  $240\text{VAC}$  or  $30\text{VDC}$  max., resistive load,  $100,000$  cycles at rated load, requires a min. load of  $20\text{mA}$  at  $24\text{V}$ ,  $125\text{VA}$  pilot duty
- NO-ARC relay, Form A,  $15\text{A}$  @  $122^\circ\text{F}$  ( $50^\circ\text{C}$ ),  $85$  to  $264\text{VAC}$ , no VDC, resistive load,  $2$  million cycles at rated load
- Universal process/retransmit, output range selectable:
  - $0$  to  $10\text{VDC}$   $\pm 15\text{mV}$  into a min.  $1,000\Omega$  load with  $2.5\text{mV}$  nominal resolution
  - $0$  to  $20\text{mA}$   $\pm 30\mu\text{A}$  into max.  $800\Omega$  load with  $5\mu\text{A}$  nominal resolution
  - Temperature stability is  $100\text{ppm}/^\circ\text{C}$

# Integrated Multi-Function

## EZ-ZONE RM

### Control Module Ordering Information

Requires 24 to 28VDC power supply, includes communication port for configuration with EZ-ZONE configurator and PC.

#### Part Number

① ② EZ-ZONE Rail Mount	③ Control Module	④ Input 1 Primary Function	⑤ Output 1 and 2 Hardware Options	⑥ Input 2	⑦ Output 3 and 4 Hardware Options	⑧ Input 3	⑨ Output 5 and 6 Hardware Options	⑩ Input 4	⑪ Output 7 and 8 Hardware Options	⑫ Connector Style	⑬ Enhanced Options	⑭ ⑮ Additional Options
RM	C											

④ Input 1 Primary Function	
1 =	Control with universal input
2 =	Control with thermistor input
3 =	Ramp/Soak control with universal input <b>(R/S applies to all loops in module)</b>
4 =	Ramp/Soak control with thermistor input <b>(R/S applies to all loops in module)</b>
5 =	Limit with universal input <b>(only valid Output 1 and 2, options will be B, F, L)</b>
6 =	Limit with thermistor input <b>(only valid Output 1 and 2, options will be B, F, L)</b>
7 =	Current transformer input <b>(not valid Output 1 and 2, options are A, B, N, P, R, S, T)</b>
9 =	Custom

⑤ Output 1 and 2 Hardware Options		
	Output 1	Output 2
A =	None	None
B =	None	Mechanical relay 5A, Form A
U =	Switched dc/open collector	None
D =	Switched dc/open collector	NO-ARC 15A power control
E =	Switched dc/open collector	Switched dc
F =	Switched dc/open collector	Mechanical relay 5A, Form A
G =	Switched dc/open collector	SSR Form A, 0.5A
H =	Mechanical relay 5A, Form C	None
J =	Mechanical relay 5A, Form C	NO-ARC 15A power control
K =	Mechanical relay 5A, Form C	Switched dc
L =	Mechanical relay 5A, Form C	Mechanical relay 5A, Form A
M =	Mechanical relay 5A, Form C	SSR Form A, 0.5A
N =	Universal process	None
P =	Universal process	Switched dc
R =	Universal process	Mechanical relay 5A, Form A
S =	Universal process	SSR Form A, 0.5A
T =	None	SSR Form A, 0.5A
Y =	SSR Form A, 0.5A	NO-ARC 15A power control
Z =	SSR Form A, 0.5A	SSR Form A, 0.5A

⑥ Input 2	
A =	None
1 =	Control with universal input
2 =	Control with thermistor input
5 =	Limit with universal input <b>(only valid Output 3 and 4, options will be B, F, L)</b>
6 =	Limit with thermistor input <b>(only valid Output 3 and 4, options will be B, F, L)</b>
7 =	Current transformer input <b>(not valid Output 3 and 4, options are N, P, R, S)</b>
R =	Auxiliary 2nd input (universal input)
P =	Auxiliary 2nd input (thermistor input)

⑦ Output 3 and 4 Hardware Options		
	Output 3	Output 4
A =	None	None
B =	None	Mechanical relay 5A, Form A
U =	Switched dc/open collector	None
D =	Switched dc/open collector	NO-ARC 15A power control
E =	Switched dc/open collector	Switched dc
F =	Switched dc/open collector	Mechanical relay 5A, Form A
G =	Switched dc/open collector	SSR Form A, 0.5A
H =	Mechanical relay 5A, Form C	None
J =	Mechanical relay 5A, Form C	NO-ARC 15A power control
K =	Mechanical relay 5A, Form C	Switched dc
L =	Mechanical relay 5A, Form C	Mechanical relay 5A, Form A
M =	Mechanical relay 5A, Form C	SSR Form A, 0.5A
N =	Universal process	None
P =	Universal process	Switched dc
R =	Universal process	Mechanical relay 5A, Form A
S =	Universal process	SSR Form A, 0.5A
T =	None	SSR Form A, 0.5A
Y =	SSR Form A, 0.5A	NO-ARC 15A power control
Z =	SSR Form A, 0.5A	SSR Form A, 0.5A

⑧ Input 3	
A =	None
1 =	Control with universal input
2 =	Control with thermistor input
5 =	Limit with universal input <b>(only valid Output 5 and 6, options will be B, F, L)</b>
6 =	Limit with thermistor input <b>(only valid Output 5 and 6, options will be B, F, L)</b>
7 =	Current transformer input <b>(not valid Output 5 and 6, options are N, P, R, S)</b>
R =	Auxiliary 2nd input (universal input)
P =	Auxiliary 2nd input (thermistor input)

(Ordering Information continued on next page.)

# Integrated Multi-Function

## EZ-ZONE RM

### Control Module Ordering Information (Continued)

Requires 24 to 28VDC power supply, includes communication port for configuration with EZ-ZONE configurator and PC.

#### Part Number

① ② EZ-ZONE Rail Mount	③ Control Module	④ Input 1 Primary Function	⑤ Output 1 and 2 Hardware Options	⑥ Input 2	⑦ Output 3 and 4 Hardware Options	⑧ Input 3	⑨ Output 5 and 6 Hardware Options	⑩ Input 4	⑪ Output 7 and 8 Hardware Options	⑫ Connector Style	⑬ Enhanced Options	⑭ ⑮ Additional Options
RM	C											

⑨ Output 5 and 6 Hardware Options		
	Output 5	Output 6
A =	None	None
B =	None	Mechanical relay 5A, Form A
U =	Switched dc/open collector	None
D =	Switched dc/open collector	NO-ARC 15A power control
E =	Switched dc/open collector	Switched dc
F =	Switched dc/open collector	Mechanical relay 5A, Form A
G =	Switched dc/open collector	SSR Form A, 0.5A
H =	Mechanical relay 5A, Form C	None
J =	Mechanical relay 5A, Form C	NO-ARC 15A power control
K =	Mechanical relay 5A, Form C	Switched dc
L =	Mechanical relay 5A, Form C	Mechanical relay 5A, Form A
M =	Mechanical relay 5A, Form C	SSR Form A, 0.5A
N =	Universal process	None
P =	Universal process	Switched dc
R =	Universal process	Mechanical relay 5A, Form A
S =	Universal process	SSR Form A, 0.5A
T =	None	SSR Form A, 0.5A
Y =	SSR Form A, 0.5A	NO-ARC 15A power control
Z =	SSR Form A, 0.5A	SSR Form A, 0.5A

⑩ Input 4	
A =	None
1 =	Control with universal input
2 =	Control with thermistor input
5 =	Limit with universal input ( <b>only valid Output 7 and 8, options will be B, F, L</b> )
6 =	Limit with thermistor input ( <b>only valid Output 7 and 8, options will be B, F, L</b> )
7 =	Current transformer input ( <b>not valid Output 7 and 8, options are N, P, R, S</b> )
R =	Auxiliary 2nd input (universal input)
P =	Auxiliary 2nd input (thermistor input)

⑪ Output 7 and 8 Hardware Options		
	Output 7	Output 8
A =	None	None
B =	None	Mechanical relay 5A, Form A
U =	Switched dc/open collector	None
D =	Switched dc/open collector	NO-ARC 15A power control
E =	Switched dc/open collector	Switched dc
F =	Switched dc/open collector	Mechanical relay 5A, Form A
G =	Switched dc/open collector	SSR Form A, 0.5A
H =	Mechanical relay 5A, Form C	None
J =	Mechanical relay 5A, Form C	NO-ARC 15A power control
K =	Mechanical relay 5A, Form C	Switched dc
L =	Mechanical relay 5A, Form C	Mechanical relay 5A, Form A
M =	Mechanical relay 5A, Form C	SSR Form A, 0.5A
N =	Universal process	None
P =	Universal process	Switched dc
R =	Universal process	Mechanical relay 5A, Form A
S =	Universal process	SSR Form A, 0.5A
T =	None	SSR Form A, 0.5A
Y =	SSR Form A, 0.5A	NO-ARC 15A power control
Z =	SSR Form A, 0.5A	SSR Form A, 0.5A
C =	6 digital inputs/outputs ( <b>valid option only if Input 4 selection = A</b> )	

⑫ Connector Style	
A =	Right angle screw connector (standard)
F =	Front screw connector (slots A, B, D and E only)

⑬ Enhanced Options	
A =	Standard bus
1 =	Standard bus and Modbus® RTU 485 (selectable via dipswitch)

⑭ ⑮ Additional Options	
Firmware, overlays, parameter settings	
AA =	Standard
AB =	Replacement connectors hardware only for the entered part number. Additional cost for the model can be disregarded as you are only ordering replacement connectors.
12 =	Class 1, Div. 2 (not available with integrated limit controller or mechanical relay options)
XX =	Custom



# Integrated Multi-Function

## EZ-ZONE RM

### High-Density Control Module Specifications (RMH)

(Select an RMH module for 4 to 16 loops of control.)

#### Line Voltage/Power

- Power consumption: 7 W, 14VA
- Any external power supply used should comply with a Class 2 or SELV rating

#### Controller

- User-selectable heat/cool, on-off, P, PI, PD, PID or alarm action, not valid for limit controllers

#### Process PID Options

- Auto-tune with TRU-TUNE+ adaptive control
- Control sampling rates: input = 10Hz, output = 10Hz (non-divisional)

#### Isolated Serial Communications

- All modules ship with standard bus protocol for configuration and communication with all other EZ-ZONE controllers
- Optional EIA-485, Modbus® RTU

#### Calibration Accuracy

- $\pm 0.1\%$  of span,  $\pm 1^\circ\text{C}$ . See user manual for details.

#### Universal Input

- Thermocouple, grounded or ungrounded sensors
- $>20\text{M}\Omega$  input impedance
- Max. of  $2\text{k}\Omega$  source resistance
- RTD 2-wire, platinum,  $100\Omega$  and  $1000\Omega$  @  $32^\circ\text{F}$  ( $0^\circ\text{C}$ ) calibration to DIN curve ( $0.00385\Omega/\Omega/^\circ\text{C}$ )
- Process, 0-20mA @  $100\Omega$ , or 0-10VDC @  $20\text{k}\Omega$  input impedance; scalable, 0-50mV

#### Thermistor Input

- 0 to  $40\text{k}\Omega$ , 0 to  $20\text{k}\Omega$ , 0 to  $10\text{k}\Omega$ , 0 to  $5\text{k}\Omega$
- 2.252k $\Omega$  and 10k $\Omega$  base at  $77^\circ\text{F}$  ( $25^\circ\text{C}$ )

#### Digital Input

- Update rate 10Hz
- Max. input 36VDC at 3mA
- Min. high state 3VDC at 0.25mA

#### Dry Contact Input

- Update rate 10Hz
- Min. open resistance  $10\text{k}\Omega$ , max. closed resistance  $50\Omega$

#### Output Hardware

- 6 digital inputs/outputs:
  - Switched dc, max. 20VDC @ 40mA, 12VDC @ 80mA
  - Open collector, max. 32VDC @ 1.5A, max. 8A per 6 outputs combined
- Electromechanical relay, Form A, 5A, 24 to 240VAC or 30VDC max., resistive load, 100,000 cycles at rated load, requires a min. load of 20mA at 24V, 125VA pilot duty

#### Tri-Process (Three universal process/retransmit outputs)

- Output range selections: 0 to 10VDC into a min.  $4\text{k}\Omega$  load
- 0 to 20mA into max.  $400\Omega$  load

#### Quad SSR

- Four SSRs at 2A each. SSRs are grouped in 2-pairs with each sharing a common. See table

Ambient Temp.	Maximum Current Per Relay	
	1 Quad SSR Card	More than 1 Quad SSR Card
-18 to $20^\circ\text{C}$	2A	1.5A
20 to $65^\circ\text{C}$	1A	0.75A

# Integrated Multi-Function

## EZ-ZONE RM

### High-Density Control Module Ordering Information

Requires 24 to 28VAC/VDC power supply, includes communication port for configuration with EZ-ZONE configurator and PC.

#### Part Number

<b>① ②</b> EZ-ZONE Rail Mount	<b>③</b> Control Module	<b>④</b> Connector Style	-	<b>⑤</b> Slot A	<b>⑥</b> Slot B	<b>⑦</b> Slot D	<b>⑧</b> Slot E	-	<b>⑨</b> Future Option	<b>⑩</b> Enhanced Options	<b>⑪ ⑫</b> Additional Options
RM	H		-					-	A		

④ Connector Style/Custom Product	
A =	Right angle screw connector (standard)
F =	Front screw connector
S =	Custom

⑤ Slot A	
1 =	4 universal inputs (T/C, RTD 2-wire, 0-10VDC, 0-20mA) with control loops
2 =	4 thermistor inputs with control loops

⑥ Slot B	
A =	None
1 =	4 universal inputs (T/C, RTD 2-wire, 0-10VDC, 0-20mA) with control loops
2 =	4 thermistor inputs with control loops

⑦ Slot D	
A =	None
1 =	4 universal inputs (T/C, RTD 2-wire, 0-10VDC, 0-20mA) with control loops
2 =	4 thermistor inputs with control loops
C =	6 digital I/O
F =	3 universal process/retransmit outputs
J =	4 mechanical relay 5A, Form A
L =	4 SSR's at 2A each. SSR's grouped in 2-pairs with each pair sharing a common.

⑧ Slot E	
A =	None
1 =	4 universal inputs (T/C, RTD 2-wire, 0-10VDC, 0-20mA) with control loops
2 =	4 thermistor inputs with control loops
C =	6 digital I/O
F =	3 universal process/retransmit outputs
J =	4 mechanical relay 5A, Form A
L =	4 SSR's at 2A each. SSR's grouped in 2-pairs with each pair sharing a common.

⑩ Enhanced Options	
A =	Standard bus
1 =	Standard bus and Modbus® RTU 485 (user-selectable)

⑪ ⑫ Additional Options	
<b>Firmware, Overlays, Parameter Settings</b>	
AA =	Standard
AB =	Replacement connectors hardware only for the entered part number
XX =	Custom

# Integrated Multi-Function

## EZ-ZONE RM

### High-Density Limit Module Specifications (RML)

(Select an RML module for 4 to 12 safety limits.)

#### Line Voltage/Power

- Power consumption: 7 W, 14VA
- Any external power supply used should comply with a Class 2 or SELV rating

#### Isolated Serial Communications

- All modules ship with standard bus protocol for configuration and communication with all other EZ-ZONE controllers
- Optional EIA-485, Modbus® RTU

#### Calibration Accuracy

- $\pm 0.1\%$  of span,  $\pm 1^\circ\text{C}$ . See user manual for details.

#### Universal Input

- Thermocouple, grounded or ungrounded sensors
- $>20\text{M}\Omega$  input impedance
- Max. of  $2\text{k}\Omega$  source resistance
- RTD 2-wire, platinum,  $100\Omega$  and  $1000\Omega$  @  $32^\circ\text{F}$  ( $0^\circ\text{C}$ ) calibration to DIN curve ( $0.00385\Omega/\Omega/^\circ\text{C}$ )
- Process, 0-20mA @  $100\Omega$ , or 0-10VDC @  $20\text{k}\Omega$  input impedance; scalable, 0-50mV

#### Thermistor Input

- 0 to  $40\text{k}\Omega$ , 0 to  $20\text{k}\Omega$ , 0 to  $10\text{k}\Omega$ , 0 to  $5\text{k}\Omega$
- 2.252k $\Omega$  and 10k $\Omega$  base at  $77^\circ\text{F}$  ( $25^\circ\text{C}$ )

#### Digital Input

- Update rate 10Hz
- Max. input 36VDC at 3mA
- Min. high state 3VDC at 0.25mA

#### Dry Contact Input

- Update rate 10Hz
- Min. open resistance  $10\text{k}\Omega$ , max. closed resistance  $50\Omega$

#### Output Hardware

- 6 digital inputs/outputs:
  - Switched dc, max. 20VDC @ 40mA, 12VDC @ 80mA
  - Open collector, max. 32VDC @ 1.5A, max. 8A per 6 outputs combined
- Electromechanical relay, Form A, 5A, 24 to 240VAC or 30VDC max., resistive load, 100,000 cycles at rated load, requires a min. load of 20mA at 24V, 125VA pilot duty

# Integrated Multi-Function

## EZ-ZONE RM

### High-Density Limit Module Ordering Information

Requires 24 to 28VAC/VDC power supply, includes communication port for configuration with EZ-ZONE configurator and PC.

#### Part Number

<b>① ②</b> EZ-ZONE Rail Mount	<b>③</b> Limit Module	<b>④</b> Connector Style	-	<b>⑤</b> Slot A	<b>⑥</b> Slot B	<b>⑦</b> Slot D	<b>⑧</b> Slot E	-	<b>⑨</b> Future Option	<b>⑩</b> Enhanced Options	<b>⑪ ⑫</b> Additional Options
RM	L		-					-	A		

④ Connector Style/Custom Product	
A =	Right angle screw connector (standard)
F =	Front screw connector
S =	Custom

⑤ Slot A	
5 =	4 universal inputs (T/C, RTD 2-wire, 0-10VDC, 0-20mA) with limit control loops
6 =	4 thermistor inputs with limit control loops

⑥ Slot B	
A =	None
5 =	4 universal inputs (T/C, RTD 2-wire, 0-10VDC, 0-20mA) with limit control loops
6 =	4 thermistor inputs with limit control loops

⑦ Slot D	
A =	None
5 =	4 universal inputs (T/C, RTD 2-wire, 0-10VDC, 0-20mA) with limit control loops
6 =	4 thermistor inputs with limit control loops
J =	4 mechanical relay 5A, Form A
C =	6 digital I/O*

⑧ Slot E	
J =	4 mechanical relay 5A, Form A
B =	1 digital input and 2 mechanical relays, 5A (1 Form A and 1 Form C)*

⑩ Enhanced Options	
A =	Standard bus
1 =	Standard bus and Modbus® RTU 485* (user-selectable)

⑪ ⑫ Additional Options	
<b>Firmware, Overlays, Parameter Settings</b>	
AA =	Standard
AB =	Replacement connectors hardware only for the entered part number
XX =	Custom

\* Reset limits via digital input, EZ key on RUI or communications commands

# Integrated Multi-Function

## EZ-ZONE RM

### Expansion Module Specifications (RME)

(Select an RME module for additional inputs and outputs and higher amperage outputs.)

#### Line Voltage/Power

- Power consumption: 7 W, 14VA
- Any external power supply used should comply with a Class 2 or SELV rating

#### Serial Communications

- All modules ship with standard bus protocol for configuration and communication with all other EZ-ZONE products

#### Wiring Termination—Touch Safe Terminals

- Right angle and front-screw type terminal blocks (slots A, B, D, E)
  - Input, power and controller output terminals, touch safe, removable, 12 to 30 AWG
- Ring lug terminal blocks (slots A and D only)
  - Input, power and controller output terminals are touch safe and removable

#### Digital Input

- Update rate 10Hz
- Max. input 36VDC at 3mA
- Min. high state 3VDC at 0.25mA

#### Dry Contact

- Min. open resistance 100k $\Omega$
- Max. closed resistance 50 $\Omega$

#### Output Hardware (6 digital inputs/outputs)

- Update rate 10Hz
- Switched dc
  - Output voltage 20VDC max.
  - Max. supply current source 40mA at 20VDC and 80mA at 12VDC
- Open collector
  - Switched voltage max. 32VDC
  - Max. switched current per output 2.5A
  - Max. switched current for all six outputs combined 10A

#### Dual Solid State Relay

- Two SSR board options, Form A, 10A max. each SSRs combined @ 24VAC min., 264VAC max., opto-isolated, without contact suppression, max. resistive load 10A per output at 240VAC, max. 20A per card at 122°F (50°C), max. 12A per card at 149°F (65°C)

#### Four Mechanical Relay

- Four electro mechanical relays, Form A, 5A, 24 to 240VAC or 30VDC max., resistive load, 100,000 cycles at rated load. Requires a min. load of 20mA at 24V, 125VA pilot duty

#### Tri-Process (Three universal process/retransmit outputs)

- Output range selections: 0 to 10VDC into a min. 4K $\Omega$  load
- 0 to 20mA into max. 400 $\Omega$  load

#### Quad SSR

- Four SSRs at 2A each. SSRs are grouped in 2-pairs with each sharing a common. See table.

Ambient Temp.	Maximum Current Per Relay	
	1 Quad SSR Card	More than 1 Quad SSR Card
-18 to 20°C	2A	1.5A
20 to 65°C	1A	0.75A

# Integrated Multi-Function

## EZ-ZONE RM

### Expansion Module Ordering Information

Requires 24 to 28VDC power supply, includes communication port for configuration with EZ-ZONE configurator and PC.

#### Part Number

<b>① ②</b> EZ-ZONE Rail Mount	<b>③</b> Expansion Module	<b>④</b> Connector Style/ Custom Product	-	<b>⑤</b> Slot A	<b>⑥</b> Slot B	<b>⑦</b> Slot D	<b>⑧</b> Slot E	-	<b>⑨ ⑩</b> Future Options	<b>⑪ ⑫</b> Additional Options
<b>RM</b>	<b>E</b>		-					-	<b>AA</b>	

④ Connector Style/Custom Product	
A =	Right angle screw connector (standard)
F =	Front screw connector (slots A, B, D and E only)
R =	Ring lug connector ( <b>if ordered, then slots B and E must be = A</b> )
S =	Custom

⑤ Slot A	
A =	None
C =	6 digital I/O
F =	3 universal process/retransmit outputs
J =	4 mechanical relay 5A, Form A
K =	2 SSRs, Form A, 10A max. each ( <b>if ordered, then slot B must be = A</b> )
L =	4 SSRs at 2 each SSR's grouped in 2-pairs with each pair sharing a common

⑥ Slot B	
A =	None
C =	6 digital I/O
F =	3 universal process/retransmit outputs
J =	4 mechanical relay 5A, Form A
L =	4 SSRs at 2 each SSR's grouped in 2-pairs with each pair sharing a common

⑦ Slot D	
A =	None
C =	6 digital I/O
F =	3 universal process/retransmit outputs
J =	4 mechanical relay 5A, Form A
K =	2 SSRs, Form A, 10A max. each ( <b>if ordered, then slot E must be = A</b> )
L =	4 SSRs at 2 each SSR's grouped in 2-pairs with each pair sharing a common

⑧ Slot E	
A =	None
C =	6 digital I/O
F =	3 universal process/retransmit outputs
L =	4 SSRs at 2 each SSR's grouped in 2-pairs with each pair sharing a common
T =	Quad inputs for external current transformers. Can do either single-phase or three-phase system measurement for all hardware outputs ordered within the expansion module (future option, contact factory).

⑪ ⑫ Additional Options	
<b>Firmware, Overlays, Parameter Settings</b>	
AA =	Standard
AB =	Replacement connectors hardware only, for the entered part number. Additional cost for the model can be disregarded as you are only ordering replacement connectors.
12 =	Class 1, Div. 2 (not available with integrated limit controller or mechanical relay options)
XX =	Custom

# Integrated Multi-Function

## EZ-ZONE RM

### High-Density Scanner Module Specifications (RMS)

(Select an RMS module for 4 to 16 auxiliary analog inputs.)

#### Line Voltage/Power

- Power consumption: 7 W, 14VA
- Any external power supply used should comply with a Class 2 or SELV rating

#### Isolated Serial Communications

- All modules ship with standard bus protocol for configuration and communication with all EZ-ZONE controllers
- Optional EIA-485, Modbus® RTU

#### Calibration Accuracy

- $\pm 0.1\%$  of span,  $\pm 1^\circ\text{C}$ . See user manual for details.

#### Universal Input

- Thermocouple, grounded or ungrounded sensors
- $>20\text{M}\Omega$  input impedance
- Max. of  $2\text{k}\Omega$  source resistance
- RTD 2-wire, platinum,  $100\Omega$  and  $1000\Omega$  @  $32^\circ\text{F}$  ( $0^\circ\text{C}$ ) calibration to DIN curve ( $0.00385\Omega/\Omega/^\circ\text{C}$ )
- Process,  $0\text{-}20\text{mA}$  @  $100\Omega$ , or  $0\text{-}10\text{VDC}$  @  $20\text{k}\Omega$  input impedance; scalable,  $0\text{-}50\text{mV}$

#### Thermistor Input

- $0$  to  $40\text{k}\Omega$ ,  $0$  to  $20\text{k}\Omega$ ,  $0$  to  $10\text{k}\Omega$ ,  $0$  to  $5\text{k}\Omega$
- $2.252\text{k}\Omega$  and  $10\text{k}\Omega$  base at  $77^\circ\text{F}$  ( $25^\circ\text{C}$ )

#### Digital Input

- Update rate  $10\text{Hz}$
- Max. input  $36\text{VDC}$  at  $3\text{mA}$
- Min. high state  $3\text{VDC}$  at  $0.25\text{mA}$

#### Dry Contact Input

- Update rate  $10\text{Hz}$
- Min. open resistance  $10\text{k}\Omega$ , max. closed resistance  $50\Omega$

#### Output Hardware

- 6 digital inputs/outputs:
  - Switched dc, max.  $20\text{VDC}$  @  $40\text{mA}$ ,  $12\text{VDC}$  @  $80\text{mA}$
  - Open collector, max.  $32\text{VDC}$  @  $1.5\text{A}$ , max.  $8\text{A}$  per 6 outputs combined
- Electromechanical relay, Form A,  $5\text{A}$ ,  $24$  to  $240\text{VAC}$  or  $30\text{VDC}$  max., resistive load,  $100,000$  cycles at rated load, requires a min. load of  $20\text{mA}$  at  $24\text{V}$ ,  $125\text{VA}$  pilot duty

# Integrated Multi-Function

## EZ-ZONE RM

### High-Density Scanner Module Ordering Information

Requires 24 to 28VAC/VDC power supply, includes communication port for configuration with EZ-ZONE configurator and PC.

#### Part Number

<b>① ②</b> EZ-ZONE Rail Mount	<b>③</b> Scanner Module	<b>④</b> Connector Style	-	<b>⑤</b> Slot A	<b>⑥</b> Slot B	<b>⑦</b> Slot D	<b>⑧</b> Slot E	-	<b>⑨</b> Future Option	<b>⑩</b> Enhanced Options	<b>⑪ ⑫</b> Additional Options
<b>RM</b>	<b>S</b>		-					-	<b>A</b>		

<b>④ Connector Style/Custom Product</b>	
A =	Right angle screw connector (standard)
F =	Front screw connector
S =	Custom

<b>⑤ Slot A</b>	
R =	4 universal inputs (T/C, RTD 2-wire, 0-10VDC, 0-20mA) without control loops
P =	4 thermistor inputs without control loops

<b>⑥ Slot B</b>	
A =	None
R =	4 universal inputs (T/C, RTD 2-wire, 0-10VDC, 0-20mA) without control loops
P =	4 thermistor inputs without control loops

<b>⑦ Slot D</b>	
A =	None
R =	4 universal inputs (T/C, RTD 2-wire, 0-10VDC, 0-20mA) without control loops
P =	4 thermistor inputs without control loops
J =	4 mechanical relay 5A, Form A
C =	6 digital I/O

<b>⑧ Slot E</b>	
A =	None
R =	4 universal inputs (T/C, RTD 2-wire, 0-10VDC, 0-20mA) without control loops
P =	4 thermistor inputs without control loops
J =	4 mechanical relay 5A, Form A
C =	6 digital I/O
B =	1 digital input and 2 mechanical relays, 4A

<b>⑩ Enhanced Options</b>	
A =	Standard bus
1 =	Standard bus and Modbus® RTU 485 (user-selectable)

<b>⑪ ⑫ Additional Options</b>	
<b>Firmware, Overlays, Parameter Settings</b>	
AA =	Standard
AB =	Replacement connectors hardware only, for the entered part number.
XX =	Custom



# Integrated Multi-Function

## EZ-ZONE RM

### Access Module Specifications (RMA)

(Select an RMA module for communication protocol options, datalogging and automatic configuration backup.)

#### Line Voltage/Power

- Power consumption: 4 W, 9VA
- Any external power supply used should comply with a Class 2 or SELV rating

#### Isolated Serial Communications

- All modules ship with standard bus protocol for configuration and communication connection to all EZ-ZONE products

#### Additional Communication Options

- EIA-232/485, Modbus® RTU
- EtherNet/IP™, Modbus® TCP, 10 BASE-T/100 BASE-TX
- DeviceNet™
- PROFIBUS DP (future option, contact factory)
- USB, controller recognized as a device

**Note:** If an access module is present, all other modules must have Modbus® disabled in order to achieve communications with all of the modules.

#### USB

- USB 1.1 device only
- Mini USB connector type
- Recognized as a mass storage device

#### Real Time Clock with Battery Backup

- Accuracy (typical): +/- 30ppm at 77°F (25°C)
- +30/-100ppm overtemperature operating range
- Battery type and typical lifetime rating: 10 years at 77°F (25°C)
- Lithium battery used, recycle properly

#### Data Logging

- 200 points
- File storage on-board module
- Common separated value (CSV) file type
- Export files via removable SD micro memory card or USB communications port

#### Memory Card

- Removable SD micro card
- 2G SD memory card provided, also accepts other storage space amounts
- -4 to 185°F (-20 to 85°C) ambient rating, non-volatile memory
- Information access to configuration files and the ability to store module auto-configuration settings and datalog files if options have been ordered

#### Auto-configuration File Backup

- Limited memory can support up to four modules
- Limited memory is fixed on board
- Unlimited memory can support up to 16 modules
- Unlimited memory utilizes removable SD micro card option

**Note:** All module parameters are backed up in memory except for USER SET 1 and USER SET 2 parameter settings and address.

# Integrated Multi-Function

## EZ-ZONE RM

### Access Module Ordering Information

Requires 24 to 28VDC power supply, includes communication port for configuration with EZ-ZONE configurator and PC.

#### Part Number

① ② EZ-ZONE Rail Mount	③ Access Module	④ Connector Style	-	⑤ Future Options	⑥ Comms. Options	⑦ Ramp/ Soak Functions	⑧ System Config. & Data Logging Options	-	⑨ ⑩ Future Options	⑪ ⑫ Additional Options
RM	A			A					AA	

④ Connector Style	
A =	Right angle screw connector (standard)
F =	Front screw connector (slots B and E only)
S =	Custom

⑥ Communication Options	
A =	None
2 =	Modbus® RTU 232/485
3 =	EtherNet/IP™, Modbus®/TCP
5 =	DeviceNet™
6 =	PROFIBUS DP

⑦ Ramp and Soak Functions	
A =	None
B =	Battery backup and real time clock for profile ramp and soak

⑧ System Configuration and Data Logging Options					
Order Option	USB "Device" Communication	Limited Auto-Configuration File Backup for Up to 4 Modules	Unlimited Auto-Configuration File Backup for Up to 16 Modules	On-Board Data Logging	Mobile Data (2G SD Card)
A		✓			
B			✓		✓
Y	✓		✓		✓
D	✓		✓	✓	✓

**USB Device Configuration:** USB access to configuration files (and data log files if data logging option is ordered) stored via onboard SD memory card. PC access to product via standard bus protocol.

**Auto-Configuration Backup:** Limited fixed onboard memory can support backing up configuration files for a maximum of four modules. The unlimited option utilizes a SD memory card to enable configuration file backup for up to 16 modules. Feature can be used for cloning configuration files to multiple modules or for easy field replacement to limit downtime.

**Data Logging:** Data log files stored on 2G SD memory card. Data files can be exported via USB communication port transfer or removing SD card into external card reader. Watlow reserves the right to ship a larger memory amount at any point in time.

**Mobile Data:** Transfer configuration files (and data logging files if data logging option is ordered) via removable SD memory card.

⑪ ⑫ Additional Options	
<b>Firmware, Overlays, Parameter Settings</b>	
AA =	Standard
AB =	Replacement connectors hardware only, for the entered part number. Additional cost for the model can be disregarded as you are only ordering replacement connectors.
12 =	Class 1, Div. 2 (not available with integrated limit controller or mechanical relay options)
XX =	Custom

### Compatible Accessories

#### Basic Remote User Interface (RUI) EZKB



The EZ-ZONE Remote User Interface (RUI and communications gateway) can be utilized as a communication gateway device to save cost, space and wiring when digital communications is being used with two or more EZ-ZONE controllers. The EZ-ZONE RUI can

also serve as a display for showing all parameter values for up to 16 EZ-ZONE controllers, again saving cost, space and wiring expenses. See page 371.

# Integrated Multi-Function

## EZ-ZONE RM

### Compatible Accessories (Continued)

#### COMPOSER® with INTUITION

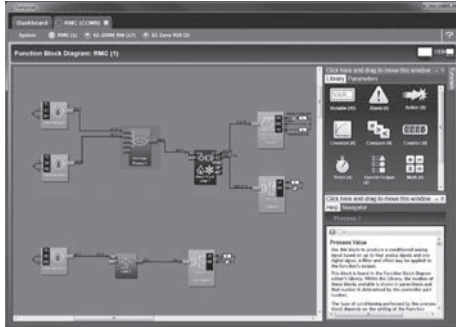

COMPOSER® with INTUITION is Watlow's new software for configuring F4T and EZ-ZONE RM controllers. It is used to set up functions such as control loops, profiles and alarms and link them to controller inputs and outputs. COMPOSER can be used to edit and save configurations while communicating with controllers and to download previously saved setups. It works without requiring the purchase of any communication options and is available as a free download at [www.watlow.com](http://www.watlow.com). See page 395.

#### EZ-ZONE Configurator Software



The EZ-ZONE configurator software is used to set up Watlow EZ-ZONE products in one simple process. It works without requiring the purchase of any communication options because it uses the standard bus communications protocol that is included with all EZ-ZONE products. EZ-ZONE configurator can be used for online and offline configurations and downloading previously saved setups. It is available as a FREE download at [www.watlow.com](http://www.watlow.com). See page 397.

#### SpecView



SpecView is designed for industrial users and includes features such as data logging, trending and support for bar code readers and touch screens. Errors are reduced for any process by creating application-specific screens. The software provides a historical replay option, easy-to-use recipe features and remote access options, including LAN, Internet and modem. See page 385.

#### Operator Interface Terminals (OIT)



Silver Series EM touchscreen operator interface terminals provide a customizable user interface, email event notifications and log and graph data for Watlow controllers and other devices. A Silver Series EM operator interface terminal paired with Watlow controllers is the perfect solution for industrial processes or machine control applications. See page 365.

#### Power Supplies - See page 418

- AC/DC power supply converter 90-264VAC to 24VDC volts.
- P/N 0847-0299-0000 – 31 W
- P/N 0847-0300-0000 – 60 W
- P/N 0847-0301-0000 – 91 W

#### EZ-ZONE RM Product Documentation

- User's manual – DVD, P/N 0601-0001-0000  
**Note:** Printed manuals are available for order on [www.watlow.com](http://www.watlow.com) under download center.

# Integrated Multi-Function

## EZ-ZONE RMZ/RMF

By combining advances in fluorescent temperature sensing with the power of the proven EZ-ZONE® RM control system, Watlow® developed a best-in-class fiber optic temperature measurement and control system that will provide industry-leading performance for your specific application. By integrating fiber optic sensing capabilities into the EZ-ZONE RM control system, users will save space, improve performance with faster response times while simplifying their control system.

Watlow's EZ-ZONE RMZ and EZ-ZONE RMF make the system adaptable to all system requirements. Both are compatible with all other modules within the EZ-ZONE RM family and self-discover all existing modules within the system making a seamless integration into your temperature control/logic system.

### EZ-ZONE RMZ Offers Fiber Optic Sensing Capabilities and EtherCAT® Communications

The EZ-ZONE RMZ integrates fiber optics, PID temperature control and EtherCAT® communications into a single package. It features multi-channel control, hosting up to four channels of fiber optic inputs as well as supporting up to 44 additional control loops from other EZ-ZONE RM modules. These modules support a wide array of capabilities including I/O, logic, current measurement, power switching and more.

### EZ-ZONE RMF Offers Additional Fiber Optic Inputs for Expansion Opportunities

The EZ-ZONE RMF module is a dedicated fiber optic input module integrating the advanced control technology of the EZ-ZONE system with one to eight channels of fiber optic temperature sensing.

The EZ-ZONE RMF can also serve as additional inputs to the EZ-ZONE RMZ enabling extensive expansion opportunities for future system needs. The EZ-ZONE RMF is ideal either as an expansion module or configured with built-in temperature control loops (outputs via EZ-ZONE RME module). The EZ-ZONE RMF can be used independently when only sensing is required.



### Benefits of Watlow's high-performance fluorescence-based temperature measurement system include:

- Compact integrated fiber optic sensing with temperature control
- Easily expands to increase number of zones as your system needs increase
- Integrates seamlessly with the temperature control system avoiding additional analog signal processing
- Faster temperature sampling rates with high resolution
- Minimizes installed footprint due to the small form factor and DIN-rail mounting
- Highly accurate fluorescent signal processing electronics
- Offers highly reliable LED light source designed to run at low currents for maximum life
- Up to 48 loops of input and control with all EZ-ZONE RM temperature control features
  - Temperature / limit loops
  - Current measurement
  - Power switching
  - Logic

### Specifications

	EZ-ZONE RMZ	EZ-ZONE RMF
Optical Inputs	1 to 4	1 to 8
Communications	EtherCAT®, Standard Bus, EtherNet/IP™, DeviceNet™, PROFIBUS DP, Modbus® TCP, Modbus® RTU	
Short Term Stability	3σ ±0.03°C	
Operating Ambient Temperature	-18°C to 65°C	
Unit to Unit Accuracy (electronics)	±0.05°C	
Module Dimensions (mm)	51.6 (H) x 44.5 (W) x 148 (D)	
Measurement Ranges**	-70°C to 300°C (calibrated at -40°C)	
Probe Materials (typical)	Polyimide/PEEK/Polyamide-imide	
System Accuracy (calibrated)	±0.05°C	
System Accuracy (uncalibrated)	±0.5°C	
Maximum Drift	0.5°C/yr	
Analog Output*	0-10V, 0-20mA	

\* Outputs via EZ-ZONE RME module.

\*\* Consult engineering center for measurement ranges outside of these values.

# Integrated Multi-Function

## EZ-ZONE RMZ/RMF

### EZ-ZONE RMZ Ordering Information

Module for EtherCAT® Communications Protocol, Universal Control Inputs, Wireless Development Communications and Legacy Communications  
Part Number



① ② ③ ④ EZ-ZONE Rail Mount	⑤ ⑥ Number of Control Loops	⑦ ⑧ Number of Optical Inputs	⑨ Wireless Comms.	⑩ Legacy Comms.	⑪ ⑫ Connector Style/Additional Options
RMZ4	-		-		

⑤ ⑥ Number of Control Loops	
AA =	No control loops
04 =	4 universal inputs (T/C, 2-wire RTD, 0-10VDC, 0-20mA)
08 =	8 universal inputs (T/C, 2-wire RTD, 0-10VDC, 0-20mA)
12 =	12 universal inputs (T/C, 2-wire RTD, 0-10VDC, 0-20mA)
16 =	16 universal inputs (T/C, 2-wire RTD, 0-10VDC, 0-20mA)
20 =	20 universal inputs (T/C, 2-wire RTD, 0-10VDC, 0-20mA)
24 =	24 universal inputs (T/C, 2-wire RTD, 0-10VDC, 0-20mA)
28 =	28 universal inputs (T/C, 2-wire RTD, 0-10VDC, 0-20mA)
32 =	32 universal inputs (T/C, 2-wire RTD, 0-10VDC, 0-20mA)
36 =	36 universal inputs (T/C, 2-wire RTD, 0-10VDC, 0-20mA)
40 =	40 universal inputs (T/C, 2-wire RTD, 0-10VDC, 0-20mA)
44 =	44 universal inputs (T/C, 2-wire RTD, 0-10VDC, 0-20mA)
48 =	48 universal inputs (T/C, 2-wire RTD, 0-10VDC, 0-20mA)

⑨ Wireless Communications	
A =	No wireless communications
B =	Bluetooth® (wireless) development communications

⑩ Legacy Communications	
A =	No wireless communications
1 =	Standard bus
2 =	Modbus®
3 =	Standard bus and Modbus®
4 =	Standard bus and DeviceNet™

⑪ ⑫ Connector Style/Additional Options	
AA =	Standard
12 =	Class 1, Div. 2
XX =	Custom

⑦ ⑧ Number of Optical Inputs	
AA =	No optical inputs
04 =	4 fiber optic inputs, temp. range 0-200°C (option for legacy communications is A only)
05 =	4 fiber optic inputs, temp. range 0-300°C (option for legacy communications is A only)

### EZ-ZONE RMF Ordering Information

Module for Fiber Optic Inputs with PID Temperature Control.  
Part Number



① ② ③ ④ EZ-ZONE Rail Mount	⑤ ⑥ Number of Fiber Optic/Temperature Control Loops	⑦ Future Option	⑧ Future Option	⑨ Future Option	⑩ Comms. Protocol	⑪ ⑫ Add'l Options
RMFA	-	A	A	A		

⑤ ⑥ Number of Fiber Optic/Temperature Control Loops	
AA =	No fiber optic/temperature control loops
1A =	1 fiber optic input without temperature control loop
1T =	1 fiber optic input with temperature control loop
2A =	2 fiber optic inputs without temperature control loop
2T =	2 fiber optic inputs with temperature control loop
3A =	3 fiber optic inputs without temperature control loop
3T =	3 fiber optic inputs with temperature control loop
4A =	4 fiber optic inputs without temperature control loop
4T =	4 fiber optic inputs with temperature control loop
5A =	5 fiber optic inputs without temperature control loop
5T =	5 fiber optic inputs with temperature control loop
6A =	6 fiber optic inputs without temperature control loop
6T =	6 fiber optic inputs with temperature control loop
7A =	7 fiber optic inputs without temperature control loop
7T =	7 fiber optic inputs with temperature control loop
8A =	8 fiber optic inputs without temperature control loop
8T =	8 fiber optic inputs with temperature control loop

⑩ Communication Protocol Options	
A =	Standard bus
1 =	Standard bus and Modbus® RTU 485
<b>Note:</b> To obtain communication protocol other than standard bus or Modbus® RTU 485 order the applicable EZ-ZONE RMZ4.	

⑪ ⑫ Additional Options	
AA =	Standard
12 =	Class 1, Div. 2
XX =	Custom

# Integrated Multi-Function

## EZ-ZONE ST

The EZ-ZONE ST integrated solid state controller from Watlow offers a complete thermal system control solution in a single package. Features include a PID temperature controller connected to a high-amperage solid state relay with the option of adding a properly sized heat sink, an over- and under-temperature limit, a power shut-down contactor and digital communications in one complete and professionally engineered product.

Because the system is modular and scalable, a user only pays for what is needed. Stacking the EZ-ZONE ST integrated controller into multiple configurations enables flexibility to standardize the product platform to solve a wide range of application needs.

This integrated controller also includes 200KA short circuit current rating (SCCR) tested up to 480VAC to minimize damage in the event of a short circuit when used with required fusing.

### Features and Benefits

#### Back panel or DIN-rail mount

- Provides several mounting options

#### Compact package

- Reduces panel size

#### Touch-safe package

- Complies with IP2X increasing user safety

#### ±0.1 percent temperature accuracy

- Provides efficient and accurate temperature control

#### 200KA SCCR with proper fusing

- Minimizes damage in the event of a short circuit

#### Agency approvals: UL®, CSA, CE, RoHS, W.E.E.E.

- Meets applications requiring agency approvals

#### Three-year warranty

- Ensures Watlow's reliability and product support

#### Off-the-shelf designed system solution

- Improves system reliability and termination reduction
- Reduces installation cost
- Eliminates incompatibility headaches often encountered with using many different components and brands

#### Profile capability

- Includes ramp and soak with four files and 40 total steps

#### Ability to communicate with programmable logic controller (PLC), personal computer (PC) or operator interface terminal (OIT)

- Optional EIA-485 Modbus® RTU
- RUI/communications gateway with optional EIA-232/485 Modbus® RTU, EtherNet/IP™/TCP Modbus®, DeviceNet™ or PROFIBUS DP. Refer to page 371 for further information.

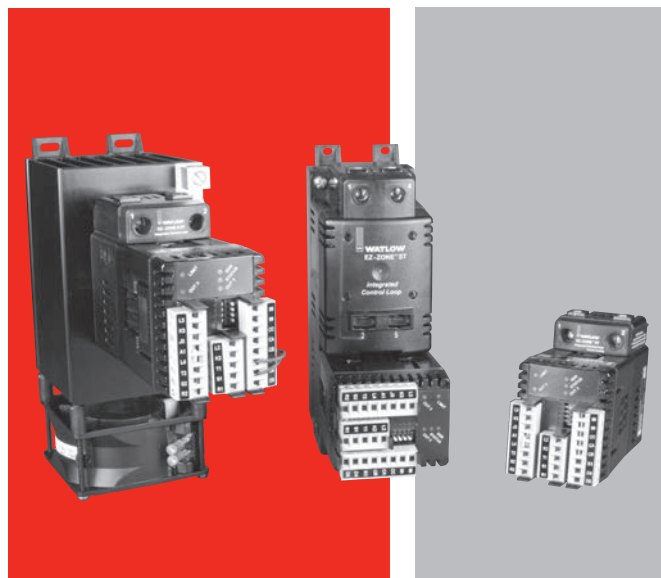

#### Solid state relay output

- Allows faster cycling, more precise control, increased heater life and improves energy efficiency
- Ability to handle up to 75 amperes
- Uses either zero-cross or phase angle control modes for flexibility to control resistive loads such as Nichrome®, tungsten or quartz lamps
- Utilizes phase angle control mode to prevent load failure or blowing fuses for tungsten or quartz loads

#### PID temperature control

- Allows single input/dual output
- Allows standard PID or adaptive TRU-TUNE+ tuning algorithms for demanding controllability requirements

#### Optional temperature limit

- Increases safety in over- and under-temperature conditions

#### Optional definite purpose mechanical contactor

- Enables circuit safety shut down driven by limit control or PID alarm output signal

#### Optional current monitoring feature

- Detects heater current flow and alarm indication of failed solid state relay (SSR) or heater zone

#### Optional SSR heat sink

- Sized and engineered for specific applications
- Factory supplied heat sink is UL® listed

#### System diagnostics

- Provides continuous self-monitoring alerts when there is any system trouble to reduce maintenance and service costs

#### PC Software—EZ-ZONE Configurator

- Wizard style configuration of controller settings
- Online or offline recipe editing

# Integrated Multi-Function

## EZ-ZONE ST

### Specifications

#### Line Voltage/Power

- 100 to 240VAC, +10/-15%; (85-264VAC), 50/60Hz,  $\pm 5\%$
- 24VAC/VDC, +10/-15%; 50/60Hz,  $\pm 5\%$
- 12VA max. power consumption without mechanical contactor in system
- 50VA max. power consumption with mechanical contactor used in system, 140VA if using external contactor
- Data retention upon power failure via nonvolatile memory

#### Environment

- 0 to 158°F (-18 to 70°C) operating temperature
- -40 to 185°F (-40 to 85°C) storage temperature
- 0 to 90% RH, non-condensing

#### Accuracy

- Calibration accuracy and sensor conformity:  $\pm 0.1\%$  of span,  $\pm 1^\circ\text{C}$  @ the calibrated ambient temperature and rated line voltage
  - Types R, S, B: 0.2%
  - Type T below  $-50^\circ\text{C}$ : 0.2%
- Calibration ambient temperature @  $77^\circ\text{F} \pm 5^\circ\text{F}$  ( $25^\circ\text{C} \pm 3^\circ\text{C}$ )
- Accuracy span:  $1000^\circ\text{F}$  ( $540^\circ\text{C}$ ) min.
- Temperature stability:  $\pm 0.1^\circ\text{F}/^\circ\text{F}$  ( $\pm 0.1^\circ\text{C}/^\circ\text{C}$ ) rise in ambient max.

#### Agency Approvals

- UL®, CSA, CE (zero cross models only), RoHS, W.E.E.E.
- Limit version features FM approval

#### Controller

- Microprocessor based user-selectable control modes
- PID module: single universal input, 2 outputs
- Limit module: single universal input, 2 outputs
- Two total additional digital input/outputs shared between PID and limit functions
- Control sampling rates: input = 10Hz, outputs = 10Hz
- Isolated EIA-485 Modbus® RTU serial communications

#### Wiring Termination—Touch Safe Terminals

- Input, power and controller output terminals touch safe removable 12 to 22 AWG
- Power load terminals 6 to 12 AWG
  - Tightening torque: 30 in.-lbs

#### Universal Input

- Thermocouple, grounded or ungrounded sensors
  - $>20\text{M}\Omega$  input impedance
  - Max. of  $20\Omega$  source resistance
- RTD 2- or 3-wire, platinum,  $100\Omega$  and  $1000\Omega$  @  $0^\circ\text{C}$  calibration to DIN curve ( $0.00385\Omega/^\circ\text{C}$ )
- Process, 0-20mA @  $100\Omega$ , or 0-10VDC @  $20\text{k}\Omega$  input impedance; scalable, 0-50mV
- Inverse scaling

#### Digital Input

- Update rate: 1Hz
- Dry contact or dc voltage DC voltage
  - Max. input: 36V at 3mA
  - Min. high state: 3V at 0.25mA
  - Max. low state: 2V
- Dry contact
  - Max. short circuit: 13mA
  - Min. open resistance:  $500\Omega$
  - Max. closed resistance:  $100\Omega$

#### Current Measurement

- Accuracy: typical  $\pm 1\text{A}$ , max. error  $\pm 3\text{A}$
- Accuracy and operating range: 0 to 75A

#### Digital Output

- Update rate: 1Hz
- Output voltage: 24V, current limit 10mA

#### Allowable Operating Range

Type J: 32 to  $1500^\circ\text{F}$  or 0 to  $815^\circ\text{C}$   
Type K:  $-328$  to  $2500^\circ\text{F}$  or  $-200$  to  $1370^\circ\text{C}$   
Type T:  $-328$  to  $750^\circ\text{F}$  or  $-200$  to  $400^\circ\text{C}$   
Type N: 32 to  $2372^\circ\text{F}$  or 0 to  $1300^\circ\text{C}$   
Type E:  $-328$  to  $1470^\circ\text{F}$  or  $-200$  to  $800^\circ\text{C}$   
Type C: 32 to  $4200^\circ\text{F}$  or 0 to  $2315^\circ\text{C}$   
Type D: 32 to  $4200^\circ\text{F}$  or 0 to  $2315^\circ\text{C}$   
Type F: 32 to  $2543^\circ\text{F}$  or 0 to  $1395^\circ\text{C}$   
Type R: 32 to  $3200^\circ\text{F}$  or 0 to  $1760^\circ\text{C}$   
Type S: 32 to  $3200^\circ\text{F}$  or 0 to  $1760^\circ\text{C}$   
Type B: 32 to  $3300^\circ\text{F}$  or 0 to  $1816^\circ\text{C}$   
RTD (DIN):  $-328$  to  $1472^\circ\text{F}$  or  $-200$  to  $800^\circ\text{C}$   
Process:  $-1999$  to 9999 units

#### Output Hardware

- User selectable for heat/cool as on-off, P, PI, PD, PID, or alarm action. Not valid for limit controls
- Electromechanical relay. Form A, rated 2A
- SSR drive: 20-28VDC low side open collector switch
- SSR, Form A, 0.5A @ 24VAC min., 264VAC max., opto-isolated, without contact suppression
- Electromechanical relay, Form A, rated 5A, auxiliary output on PID module, output 2
- Electromechanical relay, Form C, rated 5A, auxiliary output on limit module, output 3

# Integrated Multi-Function

## EZ-ZONE ST

### Specifications for Mechanical Contactor

- Insulation class: UL® Class B 266°F (130°C)
- Min. load of 100 watts
- Duty cycle: continuous

#### Contact Ratings

Full Load Amperes	Number of Poles	Line Voltage	Locked Rotor Amps	Resistive Amp Rating	Max. Horsepower	
					Voltage	Single-Phase
40	2	240/277	240	50	120	2
		480	200	50	240	3
		600	160	50		

### EZ-ZONE ST Solid State Relay with Heat Sink Specifications

#### Temperature and SSR Amperage Performance Curve Watlow 25, 40 and 75 Ampere Solid State Relays

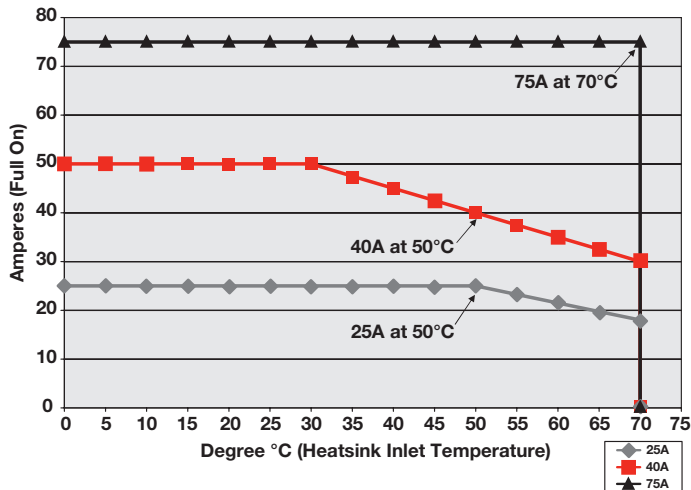

#### All Versions

	25 Amps	40 Amps	75 Amps
Current output (50°C)	25 Amps	40 Amps	75 Amps
One-cycle surge current	600Apk	850Apk	1350Apk
Max. I <sup>2</sup> t for fusing	1500A <sup>2</sup> s	3000A <sup>2</sup> s	7560A <sup>2</sup> s
Thermo resistance	0.35°C/W	0.2°C/W	0.14°C/W
Base plate temperature (max.)	116°C	115°C	112°C
Forward voltage drop	1.3Vpk	1.3Vpk	1.3Vpk
Min. holding current	150mA	150mA	250mA
Frequency	47 to 63Hz	47 to 63Hz	47 to 63Hz

#### Time Proportioned Models

Off-state leakage	1mA
Max. off-state dv/dt	500V/μsec

#### 120/240VAC

Output voltage range	24 to 280VAC
Over voltage rating	600Vpk
Input voltage range	0 to 28VDC

#### 277/600VAC

Output voltage range	48 to 660VAC
Over voltage range	1200Vpk
Input voltage range	0 to 28VDC

#### Phase Angle Models

Off-state leakage	6mA
Max. off-state dv/dt	200V/μsec

#### 120/240VAC

Output voltage range	100 to 240VAC
Over voltage rating	600Vpk
Input voltage range	2.7 to 10VDC

#### 277/600VAC

Output voltage range	260 to 600VAC
Over voltage range	1200Vpk
Input voltage range	2.8 to 10VDC



# Integrated Multi-Function

## EZ-ZONE ST

### EZ-ZONE ST with Definite Purpose Mechanical Contactor – Dimensional Drawing

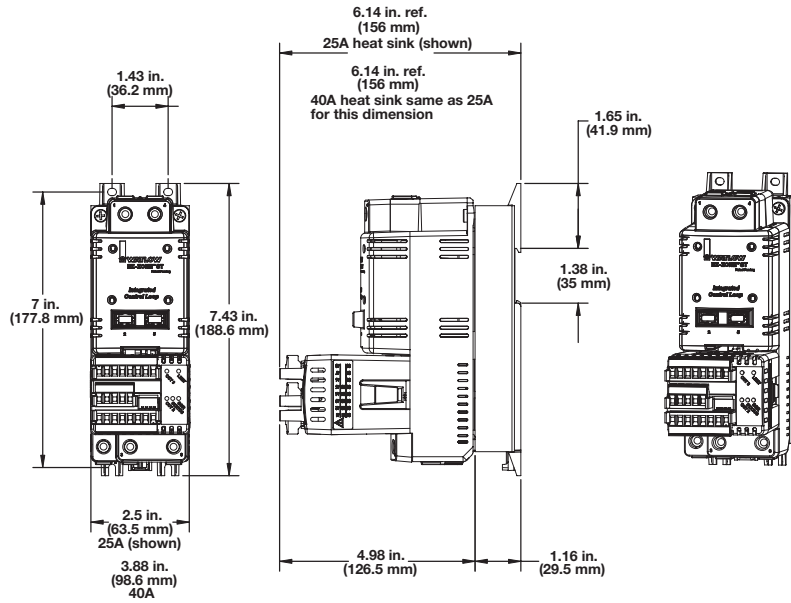

**Note:** EZ-ZONE ST must be mounted vertically (as shown) to meet amp/ambient performance curve.

### EZ-ZONE ST with 25 or 40A Heat Sink, without Definite Purpose Mechanical Contactor – Dimensional Drawing

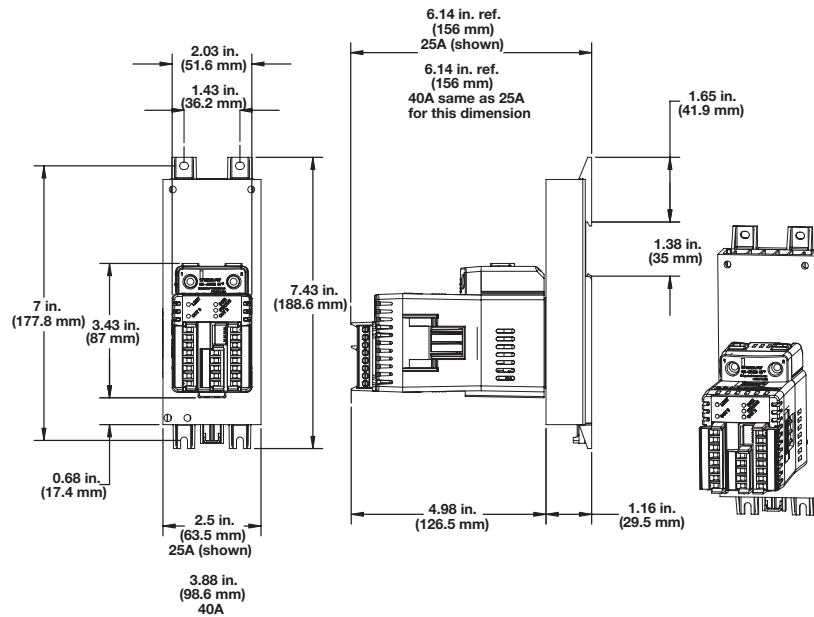

**Note:** EZ-ZONE ST must be mounted vertically (as shown) to meet amp/ambient performance curve.

# Integrated Multi-Function

## EZ-ZONE ST

### EZ-ZONE ST with 75A Heat Sink, without Definite Purpose Mechanical Contactor— Dimensional Drawing

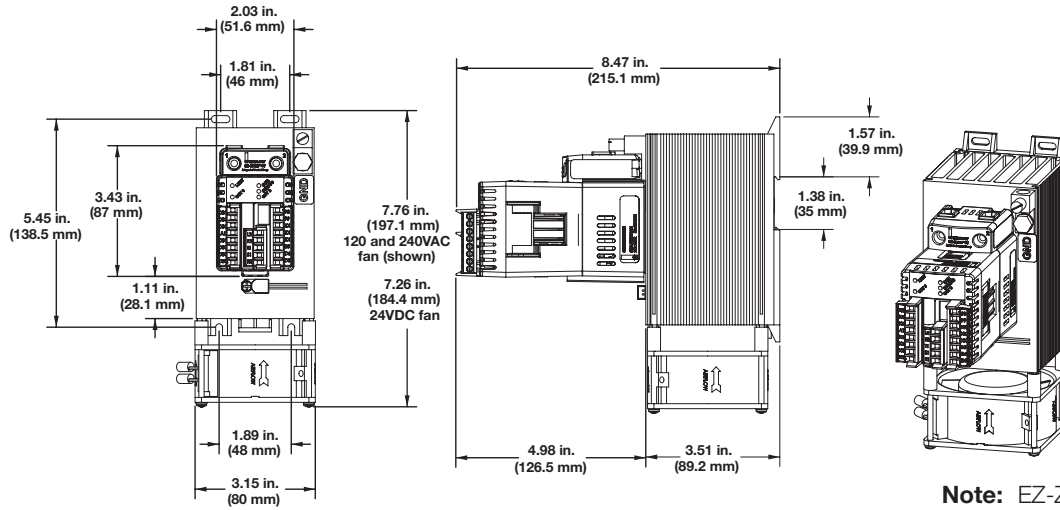

**Note:** EZ-ZONE ST must be mounted vertically (as shown) to meet amp/ambient performance curve.

## Communications

Selecting the right communications ordering option for the EZ-ZONE ST:

Correct Ordering Option Letter	Connecting To	Another EZ-ZONE Product	RUI, EZ-ZONE Configurator, SpecView	Third Party Device (PLC, PC, Touch Panel, etc.)	Silver Series Operator Interface Terminal
Option A*			Yes		
Option M**				Yes - Via Modbus®	Yes - Via Modbus®
Option A*		Yes	Yes		
Option M**		Yes		Yes - Via Modbus®	Yes - Via Modbus®

\*A = Standard bus used to connect to Watlow PC software, RUI, other EZ-ZONES  
 \*\*M = Modbus® RTU (needed to communicate to third-party devices) and standard bus. User selectable

# Integrated Multi-Function

## EZ-ZONE ST

### Ordering Information

#### Part Number

① ②	③	④	⑤ ⑥	⑦	⑧	⑨	⑩	⑪ ⑫
ST	Integrated PID Controller	Integrated Limit Controller	Mech. Cont. & Pwr. Supply	Comm.	SSR	Heat Sink/DIN-Rail Mtg.	Firmware	Customization

③ Integrated PID Controller				
	Output 1*	Output 2	Total of 2 Digital I/O Points	Current Measurement
K =	SSR drive	0.5A SSR	No	No
B =	SSR drive	0.5A SSR	Yes	No
P =	SSR drive	0.5A SSR	No	Yes
E =	SSR drive	0.5A SSR	Yes	Yes
H =	SSR drive	5A mechanical relay	No	No
D =	SSR drive	5A mechanical relay	Yes	No
J =	SSR drive	5A mechanical relay	No	Yes
C =	SSR drive	5A mechanical relay	Yes	Yes

\* Output 1 is dedicated to providing the command signal to the internal SSR.

**Note:** If 75A heat sink is selected below, then 1 digital I/O will be factory set and fixed as the SSR over-temperature digital input.

④ Integrated Limit Controller	
A =	None
L =	Limit control module with output 3, 5A Form C mechanical relay; with output 4, 2A Form A mechanical relay
B =	No limit control module but access to coil connection on mechanical contactor

⑤ ⑥ Mechanical Contactor and Power Supply Options	
AH =	No contactor and universal high voltage power supply 100-240VAC/VDC
AL =	No contactor and universal low voltage power supply 24-28VAC/VDC
B1 =	Single pole, 40A Watlow contactor, 24VAC power supply
B2 =	Single pole, 40A Watlow contactor, 110/120VAC power supply
B3 =	Single pole, 40A Watlow contactor, 208/240VAC power supply
F1 =	Dual pole, 40A Watlow contactor, 24VAC power supply
F2 =	Dual pole, 40A Watlow contactor, 110/120VAC power supply
F3 =	Dual pole, 40A Watlow contactor, 208/240VAC power supply

⑦ Communications	
A =	Standard bus used to connect to Watlow PC software, RUI, other EZ-ZONES
M =	485 Modbus® RTU (needed to communicate to third-party devices) and standard bus. User selectable

⑧ SSR	
B =	Zero cross 10A (24 to 240VAC output)
C =	Zero cross 25A (24 to 240VAC output)
D =	Zero cross 40A (24 to 240VAC output)
E =	Zero cross 50A (24 to 240VAC output)
K =	Zero cross 75A (24 to 240VAC output)
F =	Zero cross 90A (24 to 240VAC output)
G =	Zero cross 25A (48 to 600VAC output)
H =	Zero cross 40A (48 to 600VAC output)
L =	Zero cross 75A (48 to 600VAC output)
J =	Zero cross 90A (48 to 600VAC output)
M =	Phase angle 25A (100 to 240VAC output)
N =	Phase angle 40A (100 to 240VAC output)
P =	Phase angle 75A (100 to 240VAC output)
R =	Phase angle 25A (260 to 600VAC output)
S =	Phase angle 40A (260 to 600VAC output)
T =	Phase angle 75A (260 to 600VAC output)

**Note:** EZ-ZONE ST phase angle is designed to work with tungsten or quartz loads. The EZ-ZONE ST should not be used with globars, molybdenum, graphite or transformer loads.

⑨ Heat Sinks/DIN-Rail Mounting Bracket	
A =	None
B =	25A
C =	40A
D =	75A 24VDC fan cooled
E =	75A 115VAC fan cooled
F =	75A 240VAC fan cooled

**Note:** If heat sink option D, E or F is selected you must also order integrated PID controller options B, E, D or C. 75A heat sink option includes SSR over-temperature thermostat shut-down feature.

⑩ Firmware	
A =	Standard Watlow
P =	Profile ramp and soak (40 total steps, 1 to 4 profiles total)
S =	Custom

⑪ ⑫ Customization (logo, parameters, hardware, firmware)	
AA =	Standard
XX =	Letters to be determined, contact factory

**Note:** Maximum rating of final configured product is determined by the lowest component rating of either the mechanical contactor, solid-state relay or heat sink. Maximum UL® rating for product is 75A.

# Integrated Multi-Function

## EZ-ZONE ST

### Compatible Accessories

#### Basic Remote User Interface (RUI) EZKB



The EZ-ZONE Remote User Interface (RUI and communications gateway) can be utilized as a communication gateway device to save cost, space and wiring when digital communications are being used with two or more EZ-ZONE controllers. The EZ-ZONE RUI can also serve as a display for showing all parameter values for up to 16 EZ-ZONE controllers, again saving cost, space and wiring expenses. See page 371.

#### Operator Interface Terminals (OIT)



Silver Series EM touchscreen operator interface terminals provide a customizable user interface, email event notifications and log and graph data for Watlow controllers and other devices. A Silver Series EM operator interface terminal paired with Watlow controllers is the perfect solution for industrial processes or machine control applications. See page 365.

#### EZ-ZONE Configurator Software



The EZ-ZONE configurator software is used to set up Watlow EZ-ZONE products in one simple process. It works without requiring the purchase of any communication options because it uses the standard bus communications protocol that is included with all EZ-ZONE products. EZ-ZONE configurator can be used for online and offline configurations and downloading previously saved setups. It is available as a FREE download at [www.watlow.com](http://www.watlow.com). See page 397.

#### SpecView



SpecView is designed for industrial users and includes features such as data logging, trending and support for bar code readers and touch screens. Errors are reduced for any process by creating application-specific screens. The software provides a historical replay option, easy-to-use recipe features and remote access options, including LAN, Internet and modem. See page 385.

# Integrated Multi-Function

## EZ-ZONE PM

The EZ-ZONE PM panel mount controller offers control options that reduce system complexity and thermal loop ownership cost. It can be ordered as a PID controller, an over/under limit controller or its functions can be combined into an integrated controller. An option to integrate a high amperage power controller output with a high-performance PID controller and an over/under limit controller in one space-saving, panel mount package is also available. Many communications options are offered to support connectivity needs.

Because the EZ-ZONE PM controller is highly scalable, pay only for what is needed. This controller is available in 1/32, 1/16, 1/8 and 1/4 DIN panel mount packages. The EZ-ZONE PM controller is easy to use and is ideal for PID, over/under limit or integrated controller needs.

### Features and Benefits

#### Integrated PID and limit controller

- Reduces wiring time and termination complexity compared with connecting discrete products
- Decreases required panel space
- Lowers installation costs
- Increases user and equipment safety for over/under temperature conditions

#### High amperage power control output

- Drives 15 ampere resistive loads directly
- Reduces component count
- Decreases cost of ownership

#### Current monitoring

- Detects heater current flow and provides alarm indication of a failed output device or heater load

#### Serial communication capabilities

- Provides a wide range of protocol choices including Modbus® RTU, EtherNet/IP™, Modbus® TCP, PROFIBUS DP and DeviceNet™
- Supports network connectivity to a PC or PLC

#### Dual-channel controller

- Provides two PID controllers in one space-saving package

#### Enhanced control options

- Easily handles complex process problems such as cascade, ratio, differential, square-root, motorized valve control without slidewire feedback, wet-bulb/dry-bulb, compressor control and peltier loads

#### Countdown timer option

- Provides batch process control
- Supports set point change during countdown



#### Advanced PID control algorithm

- Offers TRU-TUNE®+ adaptive control to provide tighter control for demanding applications
- Provides auto-tune for fast, efficient startup

#### Configuration communications with software

- Includes Watlow standard bus communications and EZ-ZONE configurator software
- Saves time and improves reliability of controller setup

#### Ten-point linearization curve

- Improves sensor accuracy

#### Built-in sensor compensation curves

- Saves cost of buying compensated sensors
- Includes Vaisala RH and altitude (pressure) curves

#### Remote set point operation

- Supports convenient set point manipulation from a remote device such as a master control or PLC

#### Profile capability

- Offers pre-programmed process control
- Allows ramp/soak programming with 40 total steps, battery backup and real time clock

#### Retransmit output

- Supports industry needs for recording

# Integrated Multi-Function

## EZ-ZONE PM

### Features and Benefits (Continued)

#### Factory Mutual (FM) approved over/under limit with auxiliary outputs

- Increases user and equipment safety for over/under temperature conditions

#### Memory for saving and restoring parameter settings

- Decreases service calls and time down

#### Agency approvals: UL® listed, CSA, CE, RoHS, W.E.E.E., FM, SEMI F47-0200, Class 1, Div. 2 rating on selected models

- Assures prompt product acceptance
- Reduces end product documentation costs

#### Touch-safe package

- Increases safety for installer/operator
- Complies with IP2X requirements

#### Consistent termination labeling connection system

- Simplifies switching between products
- Speeds up user's system documentation

#### EZ-KEY

- Enables simple, one-touch operation of user-defined, repetitive activities

#### Programmable menu system

- Reduces setup time and increases operator efficiency

#### Three-year warranty

- Provides product support and reliability

### Specifications

#### Controller

- User-selectable heat/cool, on-off, P, PI, PD, PID or alarm action, not valid for limit controllers
- Auto-tune with TRU-TUNE+ adaptive control algorithm
- Control sampling rates: input = 10Hz, outputs = 10Hz

#### Profile Ramp/Soak - Real Time Clock and Battery Backup

- 4 profiles, 40 total steps
- Accuracy (typical):  $\pm 30$  PPM at 77°F (25°C) +30/-100 PPM at -4 to 149°F (-20 to 65°C)
- Battery type/typical life: lithium, three cumulative years unpowered at 77°F (25°C)

#### Isolated Serial Communications

- EIA-232/485, Modbus® RTU
- EtherNet/IP™/Modbus® TCP
- DeviceNet™
- PROFIBUS DP

#### Wiring Termination—Touch-Safe Terminals

- Input, power and controller output terminals are touch safe, removable, 12 to 22 AWG

#### Universal Input

- Thermocouple, grounded or ungrounded sensors greater than 20M $\Omega$  input impedance, 3 $\mu$ A open sensor detection, 2k $\Omega$  source resistance max.
- RTD 2- or 3-wire, platinum, 100 $\Omega$  and 1000 $\Omega$  @ 32°F (0°C) calibration to DIN curve (0.00385 $\Omega$ /°C)
- Process, 0-20mA @ 100 $\Omega$ , or 0-10VDC @ 20k $\Omega$ , 0-50mV at 20M $\Omega$ , 0-1000 $\Omega$  potentiometer; scalable; inverse scaling

#### Functional Operating Range

Type J: -346 to 2192°F (-210 to 1200°C)  
Type K: -454 to 2500°F (-270 to 1371°C)  
Type T: -454 to 750°F (-270 to 400°C)  
Type E: -454 to 1832°F (-270 to 1000°C)  
Type N: -454 to 2372°F (-270 to 1300°C)  
Type C: 32 to 4200°F (0 to 2315°C)  
Type D: 32 to 4200°F (0 to 2315°C)  
Type F: 32 to 2449°F (0 to 1343°C)  
Type R: -58 to 3214°F (-50 to 1767°C)  
Type S: -58 to 3214°F (-50 to 1767°C)  
Type B: 32 to 3300°F (0 to 1816°C)  
RTD (DIN): -328 to 1472°F (-200 to 800°C)  
Process: -1999 to 9999 units

#### Accuracy

- Calibration accuracy and sensor conformity:  $\pm 0.1\%$  of span,  $\pm 1^\circ\text{C}$  @ the calibrated ambient temperature and rated line voltage
  - Types R, S, B; 0.2%
  - Type T below  $-50^\circ\text{C}$ ; 0.2%
- Calibration ambient temperature @ 77°F  $\pm 5^\circ\text{F}$  (25°C  $\pm 3^\circ\text{C}$ )
- Accuracy span: 1000°F (540°C) min.
- Temperature stability:  $\pm 0.1^\circ\text{F}/^\circ\text{F}$  ( $\pm 0.1^\circ\text{C}/^\circ\text{C}$ ) rise in ambient max.

#### Thermistor Input

- 0 to 40k $\Omega$ , 0 to 20k $\Omega$ , 0 to 10k $\Omega$ , 0 to 5k $\Omega$
- 2.252k $\Omega$  and 10k $\Omega$  base at 77°F (25°C)
- Linearization curves built-in

#### Current Transformer Input

- Accepts 0-50mA signal (user-programmable range)
- Displayed operating range and resolution can be scaled and are user-programmable

#### Digital Inputs (DC Voltage)

- Max. input: 36V at 3mA
- Logic: min. high state 3V at 0.25mA, max. low state 2V

# Integrated Multi-Function

## EZ-ZONE PM

### Specifications (Continued)

#### Digital Inputs (Dry Contact)

- Logic: min. open resistance 10k $\Omega$ , max. closed resistance 50 $\Omega$
- Max. short circuit: 20mA

#### 2 Digital I/O (ordered with power supply option)

- Update rate: 10Hz
- Input type: user-selectable, dc voltage or dry contact
- Output type: switched dc
- Output voltage: 24V
- Output 5: 24mA max. or drive one 3-pole DIN-A-MITE<sup>®</sup>
- Output 6: 10mA max.

#### 6 Digital I/O (ordered with communications option)

- Update rate: 10Hz
- Input type: user-selectable, dc voltage or dry contact
- Output type: user-selectable, switched dc or open collector
- Switched dc output voltage: 12 to 24VDC, depending on current draw
- Switched dc max. supplied current: 40mA at 20VDC and 80mA at 12VDC
- Switched dc max. low state: 2V
- Open collector max. switched voltage: 32VDC
- Open collector max. switched current: 1.5A per output; 8A total for all 6 outputs

#### Output Hardware

- Switched dc: 22 to 32VDC @ 30mA max. per single output and 40mA max. total per paired outputs (1 & 2, 3 & 4)
- Open collector: 30VDC max. @ 100mA max.
- SSR, Form A, 24 to 240VAC, 1A at 50°F (10°C) to 0.5A at 149°F (65°C) resistive load, 264VAC max., opto-isolated, without contact suppression, 120/240VAC @ 20VA pilot duty
- Electromechanical relay, Form A, 24 to 240VAC or 30VDC max., 5A resistive load, 100,000 cycles at rated load, 120/240 @ 125VA or 24VAC @ 25VA pilot duty
- Electromechanical relay, Form C, 24 to 240VAC or 30VDC max., 5A resistive load, 100,000 cycles at rated load, 120/240 @ 125VA or 24VAC @ 25VA pilot duty
- NO-ARC relay, Form A, 85 to 264VAC, 15A @ 122°F (50°C), resistive load, no VDC, 2,000,000 cycles at rated load
- Universal process output: range selectable; 0 to 10VDC  $\pm$ 15mV into a min. 1,000 $\Omega$  load with 2.5mV nominal resolution; 0 to 20mA  $\pm$ 30 $\mu$ A into max. 800 $\Omega$  load with 5 $\mu$ A nominal resolution; temperature stability 100ppm/°C

#### Operator Interface

- Dual 4-digit, 7-segment LED displays
- Advance, infinity, up and down keys, plus 1 or 2 programmable EZ-KEY(s) depending on model size
- Typical display update rate: 1Hz
- RESET key substituted for infinity on all models with limit controller

#### Line Voltage/Power

- High voltage option: 85 to 264VAC, 47 to 63Hz
- Low voltage option: 20 to 28VAC, +10/-15%; 50/60Hz,  $\pm$ 5% or 12 to 40VDC
- Max. power consumption: 10VA (<sup>1</sup>/<sub>32</sub> and <sup>1</sup>/<sub>16</sub> DIN); 14VA (<sup>1</sup>/<sub>8</sub> and <sup>1</sup>/<sub>4</sub> DIN)
- Data retention upon power failure via nonvolatile memory
- Compliant with SEMI F47-0200, Figure R1-1 voltage sag requirements @ 24VAC or higher

#### Environment

- Operating temperature: 0 to 149°F (-18 to 65°C)
- Storage temperature: -40 to 185°F (-40 to 85°C)
- Relative humidity: 0 to 90% RH, non-condensing

#### Agency Approvals

- cULus<sup>®</sup> UL<sup>®</sup>/EN/CSA C22.2 No 61010-1 Listed, File E185611
- CSA C22.2 No. 24, File 158031
- UL<sup>®</sup> 50 4X indoor locations, NEMA 4X, IP65 front seal
- cULus<sup>®</sup> ANSI/ISA 12.12.01-2007, CSA-C22.2 No. 213-1987, Class 1, Div. 2, Groups A, B, C and D, temperature code T4A, File E184390 (optional)
- FM Class 3545 (limit controls)
- CE, RoHS by design, W.E.E.E.
- EtherNet/IP<sup>™</sup> and DeviceNet<sup>™</sup> ODVA Conformance Tested

# Integrated Multi-Function

## EZ-ZONE PM

### Comparison of Available Features

	1/32 DIN	1/16 DIN	1/8 DIN	1/4 DIN
<b>PID Loops</b>	1	1	1 to 2	1 to 2
<b>Profile Ramp/Soak</b>	40 total steps	40 total steps	40 total steps	40 total steps
<b>Profile Battery Backup and Real Time Clock</b>	None	None	Yes	Yes
<b>Number of Digital Inputs/Outputs</b>	0 to 2	0 to 2	0 to 8	0 to 8
<b>Number of Outputs</b>	1 to 4	1 to 6	1 to 12	1 to 12
<b>Integrated Safety Limits</b>	Limit must be ordered as separate device	1	1	1
<b>Maximum Power Output</b>	5A mechanical relay	15A NO-ARC	15A NO-ARC	15A NO-ARC
<b>Current Measurement</b>	None	Accepts 0-50mA signal from external current transformer		
<b>Standard Bus Communications</b>	Yes	Yes	Yes	Yes
<b>Field Bus Communications</b>	Modbus® RTU 485	Modbus® RTU 232/485, EtherNet/IP™, Modbus® TCP, DeviceNet™, PROFIBUS DP		
<b>10-Point Calibration Offset</b>	Yes	Yes	Yes	Yes
<b>Ratio, Differential and Square-Root</b>	None	Yes	Yes	Yes
<b>Sensor Compensation Curves - Altitude (Pressure) and Vaisala® RH</b>	None	Yes	Yes	Yes
<b>Motorized Valve Control (without Feedback)</b>	None	Yes	Yes	Yes
<b>Wet Bulb/Dry Bulb</b>	None	Yes	Yes	Yes
<b>Cascade</b>	None	None	Yes	Yes
<b>Countdown Timer</b>	Yes	Yes	Yes	Yes

### Compatible Accessories

#### EZ-ZONE Configurator Software

The EZ-ZONE configurator software is used to set up Watlow EZ-ZONE products in one simple process. It works without requiring the purchase of any communication options because it uses the standard bus communications protocol that is included with all EZ-ZONE products. EZ-ZONE configurator can be used for online and offline configurations and downloading previously saved setups. It is available as a FREE download at [www.watlow.com](http://www.watlow.com). See page 397.



#### Operator Interface Terminals (OIT)

Silver Series EM touchscreen operator interface terminals provide a customizable user interface, email event notifications and log and graph data for Watlow controllers and other devices. A Silver Series EM operator interface terminal paired with Watlow controllers is the perfect solution for industrial processes or machine control applications. See page 365.



#### SpecView

SpecView is designed for industrial users and includes features such as data logging, trending and support for bar code readers and touch screens. Errors are reduced for any process by creating application-specific screens. The software provides a historical replay option, easy-to-use recipe features and remote access options, including LAN, Internet and modem. See page 385.





# Integrated Multi-Function

## EZ-ZONE PM

### Dimensional Drawings

EZ-ZONE PM 1/32 DIN

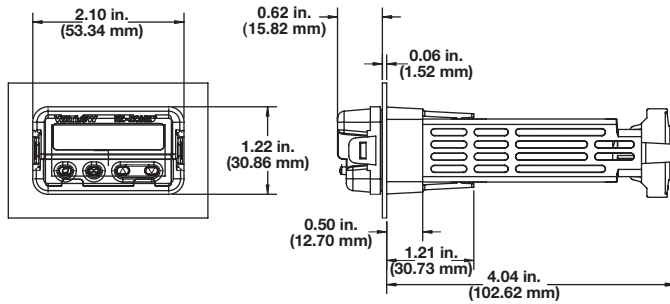

EZ-ZONE PM 1/16 DIN

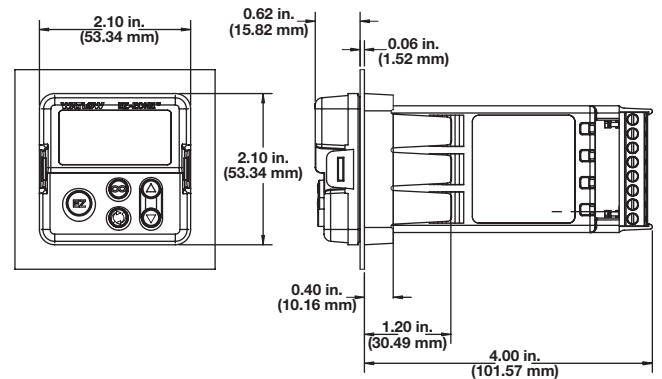

EZ-ZONE PM 1/8 DIN - Horizontal

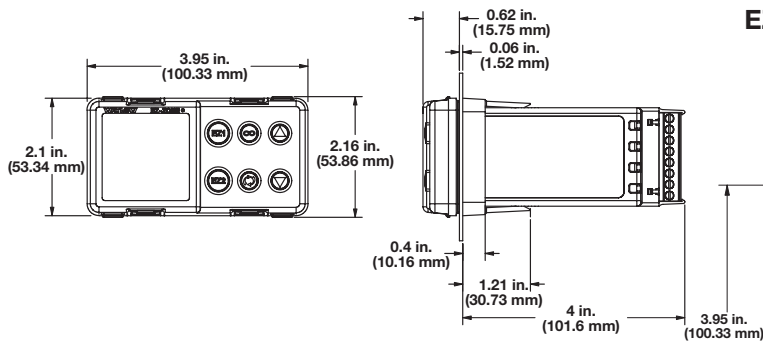

EZ-ZONE PM 1/8 DIN - Vertical

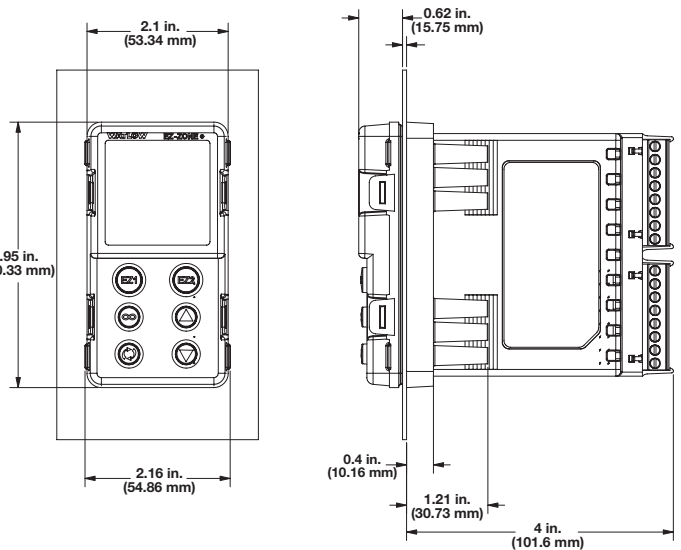

EZ-ZONE PM 1/4 DIN

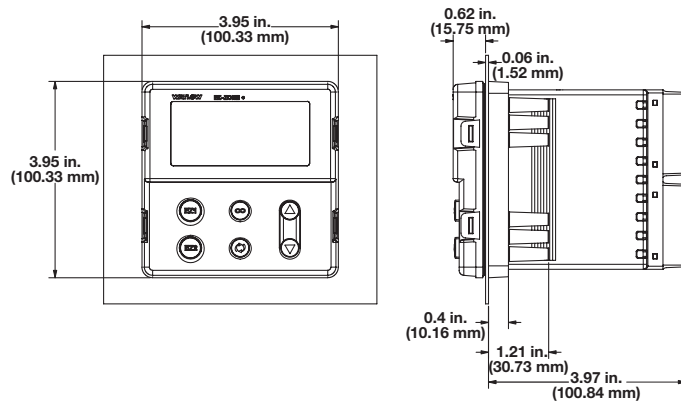

# Integrated Multi-Function

## EZ-ZONE PM

### PID Model Ordering Information

Universal Sensor Input, Standard Bus Communications, TRU-TUNE+ Adaptive Tune, Red and Green Seven-Segment Displays

#### Part Number

① ②	③	④	⑤	⑥ ⑦	⑧	⑨ ⑩ ⑪	⑫	⑬ ⑭
	Package Size	Primary Function	Power Supply, Digital I/O	Output 1 and 2 Hardware Options	Add'l Comm. Options	Future Options	Isolated Input Options	Custom Options
PM					-	AAA		

③ Package Size	
3 =	1/32 DIN
6 =	1/16 DIN
8 =	1/8 DIN vertical
9 =	1/8 DIN horizontal
4 =	1/4 DIN

④ Primary Function	
<b>Options B and E are not available with 1/32 DIN (PM3) or 1/16 DIN (PM6) models</b>	
C =	PID controller with universal input
R =	PID controller with universal input and profiling ramp/soak
B =	PID controller with universal input and profiling ramp/soak and battery back-up with real time clock
T =	PID controller with universal input and countdown timer
J =	PID controller with thermistor
N =	PID controller with thermistor input and profiling ramp/soak
E =	PID controller with thermistor input and profiling ramp/soak and battery back-up with real time clock
S =	Custom firmware

⑤ Power Supply, Digital Inputs/Outputs (I/O)	
1 =	100 to 240VAC
2 =	100 to 240VAC plus 2 digital I/O points
3 =	20 to 28VAC or 12 to 40VDC
4 =	20 to 28VAC or 12 to 40VDC, plus 2 digital I/O points

⑥ ⑦ Output 1 and 2 Hardware Options		
<b>PM3: CH, EH and KH are not valid options for 1/32 DIN package type</b>		
	Output 1	Output 2
CA =	Switched dc/open collector	None
CH =	Switched dc/open collector	NO-ARC 15A power control
CC =	Switched dc/open collector	Switched dc
CJ =	Switched dc/open collector	Mechanical relay 5A, Form A
CK =	Switched dc/open collector	SSR Form A, 0.5A
EA =	Mechanical relay 5A, Form C	None
EH =	Mechanical relay 5A, Form C	NO-ARC 15A power control
EC =	Mechanical relay 5A, Form C	Switched dc
EJ =	Mechanical relay 5A, Form C	Mechanical relay 5A, Form A
EK =	Mechanical relay 5A, Form C	SSR Form A, 0.5A
FA =	Universal process	None
FC =	Universal process	Switched dc
FJ =	Universal process	Mechanical relay 5A, Form A
FK =	Universal process	SSR Form A, 0.5A
AK =	None	SSR Form A, 0.5A
KH =	SSR Form A, 0.5A	NO-ARC 15A power control
KK =	SSR Form A, 0.5A	SSR Form A, 0.5A

⑧ Additional Communication Options	
<b>Standard bus always included</b>	
A =	None
1 =	EIA-485 Modbus® RTU

⑫ Isolated Input Options	
A =	None
D =	Isolated input 1

⑬ ⑭ Custom Options	
<b>Firmware, overlays, parameter settings</b>	
AA =	Standard EZ-ZONE PM face plate
AB =	EZ-ZONE logo and no Watlow name
AC =	No logo and no Watlow name
AG =	Conformal coating
12 =	Class 1, Div. 2 (not available with mechanical relay Output types E, H or J)

# Integrated Multi-Function

## EZ-ZONE PM

### Limit Model Ordering Information

Universal Sensor Input, Standard Bus Communications, Red and Green Seven-Segment Displays

#### Part Number

① ②	③	④	⑤	⑥ ⑦	⑧	⑨ ⑩ ⑪	⑫	⑬ ⑭
	Package Size	Primary Function	Power Supply, Digital I/O	Output 1 and 2 Hardware Options	Add'l Comm. Options	Future Options	Isolated Input Options	Custom Options
PM					-	AAA		

③ Package Size	
3 =	1/32 DIN
6 =	1/16 DIN
8 =	1/8 DIN vertical
9 =	1/8 DIN horizontal
4 =	1/4 DIN

④ Primary Function	
L =	Limit controller with universal input
M =	Limit controller with thermistor input
D =	Custom firmware

⑤ Power Supply, Digital Inputs/Outputs (I/O)	
1 =	100 to 240VAC
2 =	100 to 240VAC plus 2 digital I/O points
3 =	20 to 28VAC or 12 to 40VDC
4 =	20 to 28VAC or 12 to 40VDC, plus 2 digital I/O points

⑥ ⑦ Output 1 and 2 Hardware Options		
	Output 1	Output 2
AJ =	None	Mechanical relay 5A, Form A
CJ =	Switched dc/open collector	Mechanical relay 5A, Form A
EJ =	Mechanical relay 5A, Form C	Mechanical relay 5A, Form A

⑧ Additional Communication Options	
<b>Standard bus always included</b>	
A =	None
1 =	EIA-485 Modbus® RTU

⑫ Isolated Input Options	
A =	None
D =	Isolated input 1

⑬ ⑭ Custom Options	
<b>Firmware, overlays, parameter settings</b>	
AA =	Standard EZ-ZONE PM face plate
AB =	EZ-ZONE logo and no Watlow name
AC =	No logo and no Watlow name
AG =	Conformal coating

### Typical Block Diagrams

#### EZ-ZONE PM PID Model

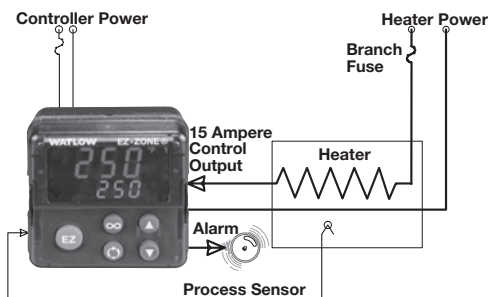

#### EZ-ZONE PM Limit Model

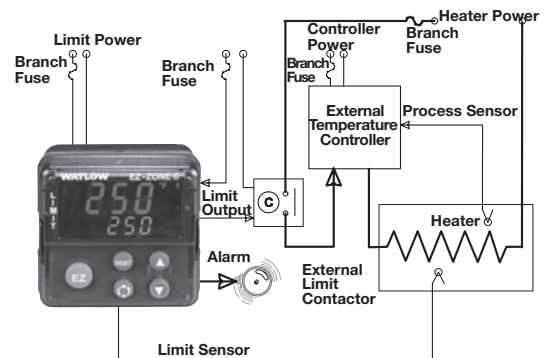

#### EZ-ZONE PM Integrated PID Model

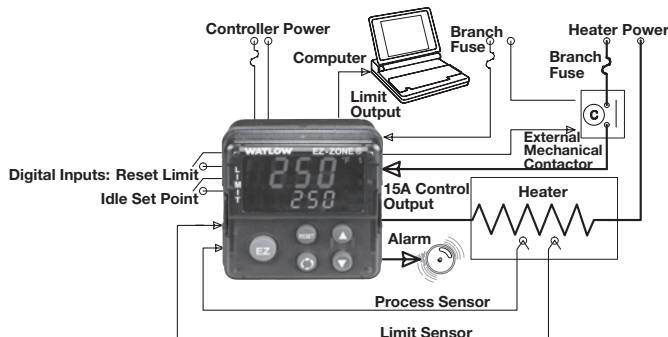

# Integrated Multi-Function

## EZ-ZONE PM

### Integrated PID Controller Model Ordering Information

Universal Sensor Input, Standard Bus Communications, TRU-TUNE+ Adaptive Tune, Red and Green Seven-Segment Displays

Part Number

① ②	③	④	⑤	⑥ ⑦	⑧	⑨	⑩ ⑪	⑫	⑬ ⑭
	Package Size	Primary Function	Power Supply, Digital I/O	Output 1 and 2 Hardware Options	Comm. Options or Add'l Digital I/O	Auxiliary Control Functions	Output 3 and 4 Hardware Options	Additional Options	Custom Options
PM					-				

③ Package Size	
6 =	1/16 DIN
8 =	1/8 DIN vertical
9 =	1/8 DIN horizontal
4 =	1/4 DIN

④ Primary Function	
<b>Options B and E are not available with 1/16 DIN (PM6) models</b>	
C =	PID controller with universal input
R =	PID controller with universal input and profiling ramp/soak
B =	PID controller with universal input and profiling ramp/soak and battery back-up with real time clock
T =	PID controller with universal input and countdown timer
J =	PID controller with thermistor input
N =	PID controller with thermistor input and profiling ramp/soak
E =	PID controller with thermistor input and profiling ramp/soak and battery back-up with real time clock
S =	Custom firmware

⑤ Power Supply, Digital Inputs/Outputs (I/O)	
1 =	100 to 240VAC
2 =	100 to 240VAC plus 2 digital I/O points
3 =	20 to 28VAC or 12 to 40VDC
4 =	20 to 28VAC or 12 to 40VDC, plus 2 digital I/O points

⑥ ⑦ Output 1 and 2 Hardware Options		
	Output 1	Output 2
CA =	Switched dc/open collector	None
CH =	Switched dc/open collector	NO-ARC 15A power control
CC =	Switched dc/open collector	Switched dc
CJ =	Switched dc/open collector	Mechanical relay 5A, Form A
CK =	Switched dc/open collector	SSR Form A, 0.5A
EA =	Mechanical relay 5A, Form C	None
EH =	Mechanical relay 5A, Form C	NO-ARC 15A power control
EC =	Mechanical relay 5A, Form C	Switched dc
EJ =	Mechanical relay 5A, Form C	Mechanical relay 5A, Form A
EK =	Mechanical relay 5A, Form C	SSR Form A, 0.5A
FA =	Universal process	None
FC =	Universal process	Switched dc
FJ =	Universal process	Mechanical relay 5A, Form A
FK =	Universal process	SSR Form A, 0.5A
AK =	None	SSR Form A, 0.5A
KH =	SSR Form A, 0.5A	NO-ARC 15A power control
KK =	SSR Form A, 0.5A	SSR Form A, 0.5A

⑧ Communication Options or Additional Digital Inputs/Outputs (I/O)	
<b>Standard bus always included</b>	
A =	None
1 =	EIA-485 Modbus® RTU
2 =	EIA-232/485 Modbus® RTU
3 =	EtherNet/IP™/Modbus® TCP
5 =	DeviceNet™
6 =	PROFIBUS DP
C =	6 digital I/O (not available on 1/16 DIN models)
D =	6 digital I/O and EIA-485 Modbus® RTU (not available on 1/16 DIN models)

⑨ Auxiliary Control Functions	
A =	None
C =	2nd PID channel with universal input - not available on 1/16 DIN models
J =	2nd PID channel with thermistor input - not available on 1/16 DIN models
R =	Auxiliary 2nd input (universal input)
P =	Auxiliary 2nd input (thermistor input)
T =	Current transformer input (not valid Output 3 and 4 selections = FA, FC, FJ and FK)
L =	Integrated limit controller with universal input (only valid Output 3 and 4 selections = CJ, EJ and AJ)
M =	Integrated limit controller with thermistor input (only valid Output 3 and 4 selections = CJ, EJ and AJ)

1/16 DIN Models: If communication options 2 thru 6 is ordered in previous digit, then Option A must be ordered here.

All Models: Auxiliary input supports remote set point, backup sensor ratio, differential and wet-bulb/dry-bulb input.

⑩ ⑪ Output 3 and 4 Hardware Options		
	Output 3	Output 4
AA =	None	None
AJ =	None	Mechanical relay 5A, Form A
AK =	None	SSR Form A, 0.5A
CA =	Switched dc/open collector	None
CC =	Switched dc/open collector	Switched dc
CH =	Switched dc/open collector	NO-ARC 15A power control
CJ =	Switched dc/open collector	Mechanical relay 5A, Form A
CK =	Switched dc/open collector	SSR Form A, 0.5A
EA =	Mechanical relay 5A, Form C	None
EC =	Mechanical relay 5A, Form C	Switched dc
EH =	Mechanical relay 5A, Form C	NO-ARC 15A power control
EJ =	Mechanical relay 5A, Form C	Mechanical relay 5A, Form A
EK =	Mechanical relay 5A, Form C	SSR Form A, 0.5A
FA =	Universal process	None
FC =	Universal process	Switched dc
FJ =	Universal process	Mechanical relay 5A, Form A
FK =	Universal process	SSR Form A, 0.5A
KH =	SSR Form A, 0.5A	NO-ARC 15A power control
KK =	SSR Form A, 0.5A	SSR Form A, 0.5A

1/16 DIN Models: If communication options 2 thru 6 is ordered in previous digit, then Option AA must be ordered here.

1/16 DIN Models: Output options CH, EH and KH are not valid.

⑫ Additional Options	
A =	Standard
C =	Enhanced firmware which includes compressor control, cascade, ratio, differential, square-root and motorized valve control without feedback.
D =	Standard with isolated input 1, input 2 is always isolated
F =	Enhanced firmware with isolated input 1, input 2 is always isolated

**Note:** Auxiliary control function C or J required for cascade control

⑬ ⑭ Custom Options	
AA =	Standard EZ-ZONE PM face plate
AB =	EZ-ZONE logo and no Watlow name
AC =	No logo and no Watlow name
AG =	Conformal coating
12 =	Class 1, Div. 2 (not available with integrated limit Option "L" or "M", or with Output types E, H, or J)

# Integrated Multi-Function

## EZ-ZONE PM

### Enhanced Limit Model Ordering Information

Universal Sensor Input, Configuration Communications, Red and Green Seven-Segment Displays

Part Number

① ②	③	④	⑤	⑥ ⑦	⑧	⑨	⑩ ⑪	⑫	⑬ ⑭
	Package Size	Primary Function	Power Supply, Digital I/O	Output 1 and 2 Hardware Options	Add'l Comm. Options	Future Option	Output 3 and 4 Hardware Options	Isolated Input Options	Custom Options
PM					-	A			

③ Package Size	
6 =	1/16 DIN
8 =	1/8 DIN vertical
9 =	1/8 DIN horizontal
4 =	1/4 DIN

④ Primary Function	
L =	Limit controller with universal input
M =	Limit controller with thermistor input
D =	Custom firmware

⑤ Power Supply, Digital Inputs/Outputs (I/O)	
1 =	100 to 240VAC
2 =	100 to 240VAC plus 2 digital I/O points
3 =	20 to 28VAC or 12 to 40VDC
4 =	20 to 28VAC or 12 to 40VDC, plus 2 digital I/O points

⑥ ⑦ Output 1 and 2 Hardware Options		
	Output 1	Output 2
AJ =	None	Mechanical relay 5A, Form A
CJ =	Switched dc/open collector	Mechanical relay 5A, Form A
EJ =	Mechanical relay 5A, Form C	Mechanical relay 5A, Form A

⑧ Additional Communication Options	
<b>Standard bus always included</b>	
A =	None
1 =	EIA-485 Modbus® RTU
2 =	EIA-232/485 Modbus® RTU
3 =	EtherNet/IP™ Modbus® TCP
5 =	DeviceNet™
6 =	PROFIBUS DP

⑩ ⑪ Output 3 and 4 Hardware Options		
	Output 3	Output 4
AA =	None	None
AJ =	None	Mechanical relay 5A, Form A
AK =	None	SSR Form A, 0.5A
CA =	Switched dc/open collector	None
CC =	Switched dc/open collector	Switched dc
CJ =	Switched dc/open collector	Mechanical relay 5A, Form A
CK =	Switched dc/open collector	SSR Form A, 0.5A
EA =	Mechanical relay 5A, Form C	None
EC =	Mechanical relay 5A, Form C	Switched dc
EJ =	Mechanical relay 5A, Form C	Mechanical relay 5A, Form A
EK =	Mechanical relay 5A, Form C	SSR Form A, 0.5A
FA =	Universal process	None
FC =	Universal process	Switched dc
FJ =	Universal process	Mechanical relay 5A, Form A
FK =	Universal process	SSR Form A, 0.5A
KK =	SSR Form A, 0.5A	SSR Form A, 0.5A

<sup>1</sup>/<sub>16</sub> DIN Models: If communication options 2 thru 6 is ordered in previous digit, then Option AA must be ordered here.

⑫ Isolated Input Options	
A =	None
D =	Isolated input 1

⑬ ⑭ Custom Options	
<b>Firmware, overlays, parameter settings</b>	
AA =	Standard EZ-ZONE PM face plate
AB =	EZ-ZONE logo and no Watlow name
AC =	No logo and no Watlow name
AG =	Conformal coating

# Integrated Multi-Function

## EZ-ZONE PM Express

The EZ-ZONE PM Express panel mount controller is an industry-leading PID controller that allows optimal performance utilizing simple control and menu functionality without complex features. It is ideal for basic applications and usage levels.

The EZ-ZONE PM Express is the next generation controller to follow the legacy of Watlow's SERIES 93, SERIES 935 AND SERIES SD controllers that offer easy-to-use features to perform many basic applications. The EZ-ZONE PM Express includes one universal input and an option for up to two outputs and is available in 1/32, 1/16, 1/8 and 1/4 DIN panel mount packages. It can be ordered as a PID process controller or as a dedicated over and under-temperature limit controller.

The EZ-ZONE PM Express is a valuable addition to the EZ-ZONE PM controller family which also includes the EZ-ZONE PM integrated controller and the EZ-ZONE PM standard version.

### Features and Benefits

#### Simplified menu

- Fits basic applications with a user-friendly interface supported by two menus and a streamlined list of parameters
- Eliminates complexity often experienced with more advanced controllers and unnecessary features
- Reduces training costs and user programming errors

#### PID auto-tune

- Provides auto-tune for fast, efficient startup

#### Standard bus communications

- Allows easy product configuration via PC communications protocol and free software
- Saves time, simplifies programming process and improves reliability of controller setup

#### Factory Mutual (FM) approved over and under limit with auxiliary outputs

- Increases user and equipment safety for over and under-temperature conditions

#### Agency approvals: UL® listed, CSA, CE, RoHS, W.E.E.E., FM, SEMI F47-0200, Class 1, Div. 2 rating on selected models

- Assures prompt product acceptance
- Reduces end product documentation costs

#### Front panel removable

- Saves time and labor for replacements and troubleshooting



#### P3T armor sealing system

- Complies with NEMA 4X, IP65 specifications
- Allows controller to be cleaned and washed
- Certified UL® 50 independent to NEMA 4X specification

#### Touch-safe package

- Increases installer and operator safety
- Complies with IP2X requirements

#### Consistent Termination Labeling (CTL) connection system

- Simplifies switching between products
- Speeds up user's system documentation

#### Three-year warranty

- Demonstrates Watlow's reliability and product support

#### High-ampere power control output

- Drives 15 ampere resistive loads direct
- Reduces component count
- Saves panel space and simplifies wiring
- Reduces cost of ownership

# Integrated Multi-Function

## EZ-ZONE PM Express

### Specifications

#### Line Voltage/Power

- 85 to 264VAC, 47 to 63Hz
- 20 to 28VAC, +10/-15%; 50/60Hz,  $\pm 5\%$
- 12 to 40VDC
- 10VA ( $1/32$  and  $1/16$  DIN) 14VA ( $1/8$  and  $1/4$  DIN) max. power consumption
- Data retention upon power failure via non-volatile memory
- Compliant with SEMI F47-0200, Figure R1-1 voltage sag requirements @ 24VAC or higher

#### Environment

- 0 to 149°F (-18 to 65°C) operating temperature
- -40 to 185°F (-40 to 85°C) storage temperature
- 0 to 90% RH, non-condensing

#### Accuracy

- Calibration accuracy and sensor conformity:  $\pm 0.1\%$  of span,  $\pm 1^\circ\text{C}$  @ the calibrated ambient temperature and rated line voltage
  - Type S: 0.2%
  - Type T below  $-50^\circ\text{C}$ : 0.2%
- Calibration ambient temperature @  $77^\circ\text{F} \pm 5^\circ\text{F}$  ( $25^\circ\text{C} \pm 3^\circ\text{C}$ )
- Accuracy span:  $1000^\circ\text{F}$  ( $540^\circ\text{C}$ ) min.
- Temperature stability:  $\pm 0.1^\circ\text{F}/^\circ\text{F}$  ( $\pm 0.1^\circ\text{C}/^\circ\text{C}$ ) rise in ambient max.

#### Agency Approvals

- cULus® UL®/EN/CSA C22.2 No 61010-1 Listed, File E185611
- CSA C22.2 No. 24, File 158031
- UL® 50 4X indoor locations, NEMA 4X, IP65 front seal
- cULus® ANSI/ISA 12.12.01-2007, CSA-C22.2 No. 213-1987, Class 1, Div. 2, Groups A, B, C and D, temperature code T4A, File E184390 (optional)
- CE, RoHS by design, W.E.E.E.

#### Controller

- User selectable heat/cool, on-off, P, PI, PD, PID or alarm action, not valid for limit controllers
- Auto-tune with control algorithm
- Control sampling rates: input = 10Hz, outputs = 10Hz
- Input and output capacity per controller type ordering information

#### Serial Communications

- Isolated communications
- Standard bus configuration protocol

#### Wiring Termination—Touch-Safe Terminals

- Input, power and controller output terminals are touch safe, removable, 12 to 22 AWG

#### Universal Input

- Thermocouple, grounded or ungrounded sensors, greater than  $20\text{M}\Omega$  input impedance,  $2\text{k}\Omega$  source resistance max.
  - Non-isolated to switched dc and process output
- RTD 2- or 3-wire, platinum,  $100\Omega$  @  $0^\circ\text{C}$  calibration to DIN curve ( $0.00385 \Omega/\Omega/^\circ\text{C}$ )
- Process, 4-20mA @  $100\Omega$ , or 0-10VDC @  $20\text{k}\Omega$  input impedance; scalable

#### Functional Operating Range

Type J:  $-346$  to  $2192^\circ\text{F}$  ( $-210$  to  $1200^\circ\text{C}$ )  
Type K:  $-454$  to  $2500^\circ\text{F}$  ( $-270$  to  $1371^\circ\text{C}$ )  
Type T:  $-454$  to  $750^\circ\text{F}$  ( $-270$  to  $400^\circ\text{C}$ )  
Type E:  $-454$  to  $1832^\circ\text{F}$  ( $-270$  to  $1000^\circ\text{C}$ )  
Type N:  $-454$  to  $2372^\circ\text{F}$  ( $-270$  to  $1300^\circ\text{C}$ )  
Type C:  $32$  to  $4200^\circ\text{F}$  ( $0$  to  $2315^\circ\text{C}$ )  
Type D:  $32$  to  $4200^\circ\text{F}$  ( $0$  to  $2315^\circ\text{C}$ )  
Type F:  $32$  to  $2449^\circ\text{F}$  ( $0$  to  $1343^\circ\text{C}$ )  
Type R:  $-58$  to  $3214^\circ\text{F}$  ( $-50$  to  $1767^\circ\text{C}$ )  
Type S:  $-58$  to  $3214^\circ\text{F}$  ( $-50$  to  $1767^\circ\text{C}$ )  
Type B:  $32$  to  $3300^\circ\text{F}$  ( $0$  to  $1816^\circ\text{C}$ )  
RTD (DIN):  $-328$  to  $1472^\circ\text{F}$  ( $-200$  to  $800^\circ\text{C}$ )  
Process:  $-1999$  to  $9999$  units

#### Output Hardware

- Switched dc =  $22$  to  $32\text{VDC}$  @  $30\text{mA}$
- Open collector =  $30\text{VDC}$  max. @  $100\text{mA}$  max. current sink
- Solid state relay (SSR), Form A,  $0.5\text{A}$  @  $24\text{VAC}$  min.,  $264\text{VAC}$  max., opto-isolated, without contact suppression
- Electromechanical relay, Form C,  $24$  to  $240\text{VAC}$  or  $30\text{VDC}$  max.,  $5\text{A}$  resistive load,  $100,000$  cycles at rated load
- Electromechanical relay, Form A,  $24$  to  $240\text{VAC}$  or  $30\text{VDC}$  max.,  $5\text{A}$  resistive load,  $100,000$  cycles at rated load
- NO-ARC relay, Form A,  $24$  to  $240\text{VAC}$ ,  $15\text{A}$  @  $122^\circ\text{F}$  ( $50^\circ\text{C}$ ), resistive load, no VDC,  $2$  million cycles at rated load
- Universal process output: range selectable;  $0$  to  $10\text{VDC} \pm 15\text{mV}$  into a min.  $1,000\Omega$  load with  $2.5\text{mV}$  nominal resolution;  $4$  to  $20\text{mA} \pm 30\mu\text{A}$  into max.  $800\Omega$  load with  $5\mu\text{A}$  nominal resolution; temperature stability  $100\text{ppm}/^\circ\text{C}$

#### Operator Interface

- Dual 4 digit, 7 segment LED displays
- Typical display update rate 1Hz
- Advance, infinity (RESET), up and down keys plus an A/M-KEY (not available in  $1/32$  DIN)
- A/M-KEY automatically programmed as an auto/manual transfer mode function on PID models.

# Integrated Multi-Function

## EZ-ZONE PM Express

### Typical Block Diagrams

EZ-ZONE PM EXPRESS PID Model

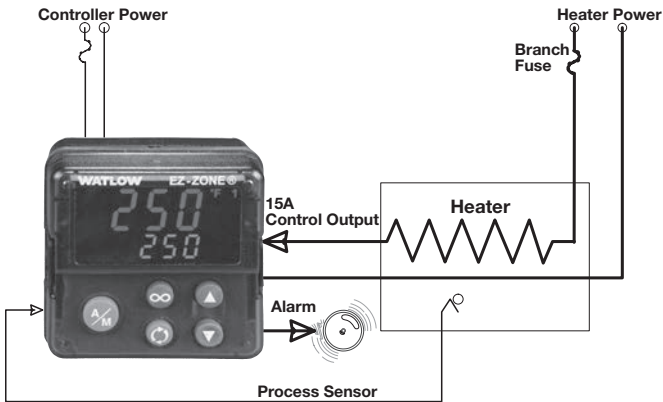

EZ-ZONE PM EXPRESS Limit Model

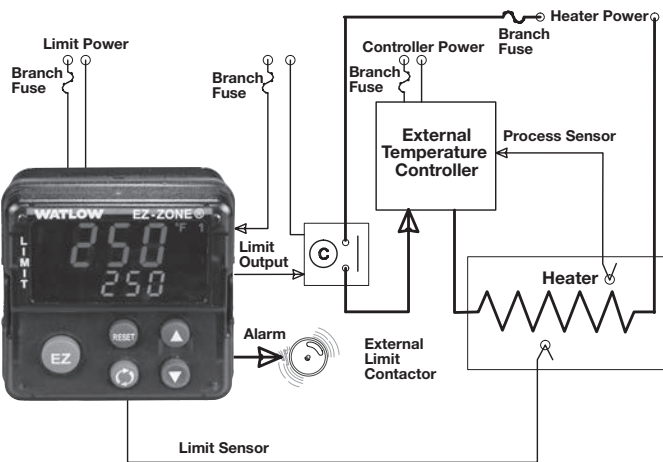

### Dimensional Drawings

EZ-ZONE PM 1/32 DIN

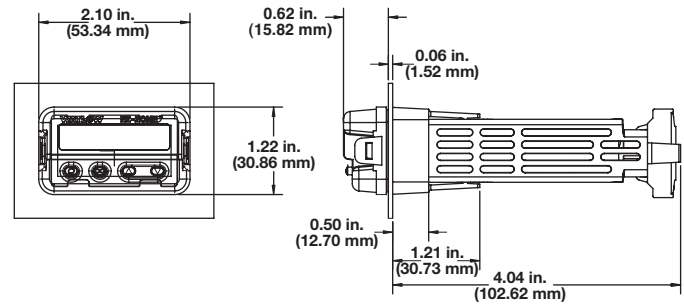

EZ-ZONE PM 1/16 DIN

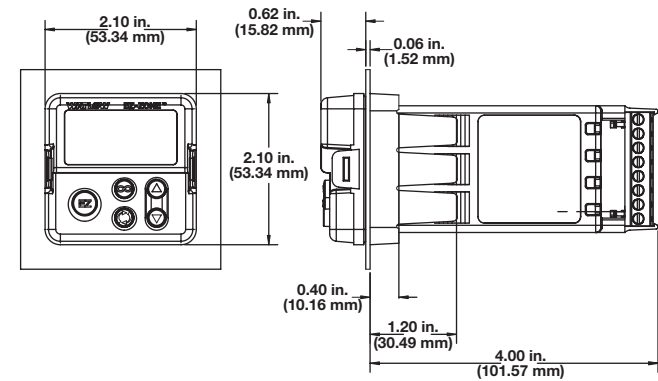



# Integrated Multi-Function

## EZ-ZONE PM Express

### Ordering Information

Universal Sensor Input, Standard Bus Communications, Dual Line Red over Green Seven-Segment Displays

#### Part Number

① ②	③	④	⑤	⑥ ⑦	⑧ ⑨ ⑩ ⑪	⑫	⑬ ⑭
	Package Size	Primary Function	Power Supply	Output 1 and 2 Hardware Options	Future Options	Menu Type	Add'l Options
PM					AAAA	B	

③ Package Size	
3 =	1/32 DIN
6 =	1/16 DIN
8 =	1/8 DIN vertical (future option)
9 =	1/8 DIN horizontal (future option)
4 =	1/4 DIN (future option)

④ Primary Function	
C =	PID controller with universal input
L =	Limit controller with universal input (only valid Output 1 and 2 selections = AJ, CJ or EJ)

⑤ Power Supply	
1 =	100 to 240VAC
3 =	20 to 28VAC or 12 to 40VDC

⑥ ⑦ Output 1 and 2 Hardware Options		
	Output 1	Output 2
AJ =	None	Mechanical relay 5A, Form A
CA =	Switched dc/open collector	None
CH =	Switched dc/open collector	NO-ARC 15A power control
CC =	Switched dc/open collector	Switched dc
CJ =	Switched dc/open collector	Mechanical relay 5A, Form A
CK =	Switched dc/open collector	SSR Form A, 0.5A
EA =	Mechanical relay 5A, Form C	None
EH =	Mechanical relay 5A, Form C	NO-ARC 15A power control
EC =	Mechanical relay 5A, Form C	Switched dc
EJ =	Mechanical relay 5A, Form C	Mechanical relay 5A, Form A
EK =	Mechanical relay 5A, Form C	SSR Form A, 0.5A
FA =	Universal process	None
FC =	Universal process	Switched dc
FJ =	Universal process	Mechanical relay 5A, Form A
FK =	Universal process	SSR Form A, 0.5A
AK =	None	SSR Form A, 0.5A
KH =	SSR Form A, 0.5A	NO-ARC 15A power control
KK =	SSR Form A, 0.5A	SSR Form A, 0.5A

⑫ Menu Type	
B =	PM Express with English manual

⑬ ⑭ Additional Options	
AA =	Standard EZ-ZONE PM face plate
AB =	EZ-ZONE logo, no Watlow name
AC =	No logo, no Watlow name
AG =	Conformal coating
12 =	Class 1, Div. 2 (not available with mechanical relay Output types E, H or J)

# Integrated Multi-Function

## SERIES EHG® SL10

The SERIES EHG® SL10 integrated, multi-function controller is a key component to a powerful system that includes a heater, an adjustable set point temperature controller, a high/low temperature alert, a power switching device and a high temperature safety limit. Its agency recognized controller/safety limit meets UL® 1998 and CE 60730 requirements.

An optional display/communications module can be easily added in the field to provide a digital display indication, an adjustment of set point, RS-485 Modbus® communications and other Human Machine Interface (HMI) features. As a scalable system, only what is needed can be purchased.

The EHG SL10 controllers' easy to install, compact design, inherent reliability and integrated limit functions offer unmatched value. It is designed for easy integration with Watlow heaters to simplify engineering, reduce component count for new equipment and decrease ownership cost. For original equipment manufacturers (OEMs), the EHG SL10 controller's CE, Semi-S2 compliance and UL® recognition reduces time and costs associated with global agency testing and validation. U.S. Patent Number 8,044,329.

### Features and Benefits

#### Extended temperature range -0.4 to 999°F (-18 to 537°C)

- Ideal for demanding environments

#### Process controller and safety limit in one package

- Meets UL® 1998 and CE 60730 requirements
- Eliminates the need for a thermal fuse on a heater
- Eliminates replacement of heater when fuse fails

#### Optional display/communications module

- Allows easy upgrade on to base device
- Offers low cost field upgrade
- Provides easy, snap-on installation

#### Accurate and flexible temperature process controller

- Replaces problematic bi-metal thermostats with accurate electronic temperature process controller
- Allows easy change of process parameters

#### Extended set point/process range

- Supports broader applications

#### Ambient operating temperature range 32 to 158°F (0 to 70°C)

- Increases reliability when mounting in harsh temperature environments or in close proximity to heaters

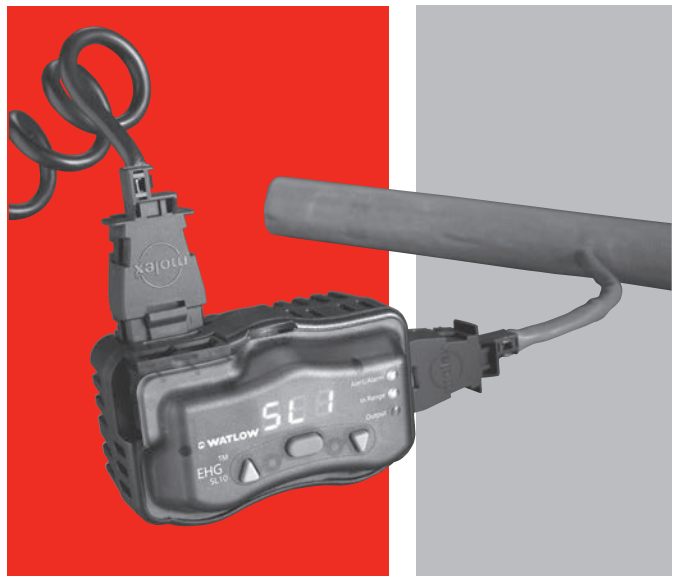

#### Integrated high/low temperature alert signal relay

- Provides dry contact output to activate external alarm or process function
- Signals control status with three integrated LEDs
- Allows a signal of up to two amperes 30VAC/VDC, Form A to alert if process temperature is out of range limits

#### Health check diagnostics

- Monitors maximum heater process temperature, maximum ambient temperature and thermocouple operation
- Provides health check signal to inform operator that the process is working correctly

#### Universal power supply

- Allows an input of 85 to 264VAC, 50/60Hz
- Provides safe control of up to 2400 watts with 10 amperes switching in both controller and safety limit

#### Can be switched from on-off and PID algorithm

- Increases product life (on-off control is default)
- Offers selectable PID control algorithm for tighter temperature uniformity

#### Universal 1/8 turn mounting bracket

- Allows mounting to most surfaces
- Provides flexible mounting—either horizontally or vertically

### Typical Applications

#### Semiconductor processing

- Gas delivery lines

#### Life sciences

- Laboratory equipment
- Medical equipment
- Pharmaceutical

#### Foodservice equipment

- Warming and serving equipment
- Food holding cabinets

# Integrated Multi-Function

## SERIES EHG SL10

### Technical Information

#### Specifications

##### Operational

- Two, Type K thermocouple inputs - process temperature control and safety limit
- Process temperature output - 10A NO-ARC relay
- Safety limit alarm - 10A relay
- High/low temperature alert - 2A 30VAC/VDC, Form A (single pole, normally open contact)
- On-off temperature controller algorithm, upgraded via communications to PID algorithm (min. cycle time 30 seconds)

##### Accuracy

- Calibration accuracy at the calibrated ambient temperature and rated line voltage is  $\pm 4^{\circ}\text{C}$

##### Standard Molex® connectors

- Controllers are integral to the heater and are supplied by Watlow

##### Power

- Isolated universal power supply 85 to 264VAC, 50/60Hz
- Up to 2400 W with 10A switching capability

##### NO-ARC Relay

- 10A switching
- 4.5 million cycles

##### Environmental

- Ambient operating temperature range 32 to 158°F (0 to 70°C)

##### Agency Approvals

- UL® 1998/ C-UL®
- CE 60730
- Semi-S2

#### SERIES EHG Versus Thermostat (typical application)

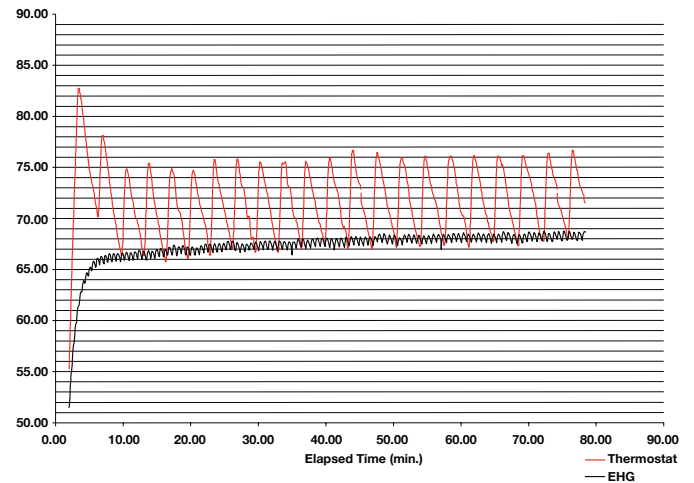

#### Dimensions

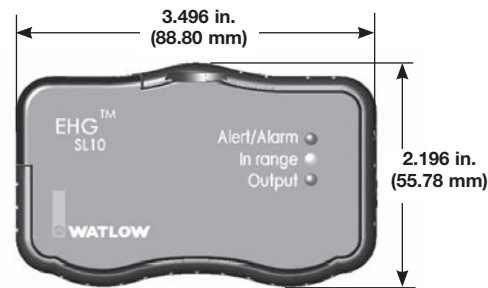

Base Unit



Without Optional Module



With Optional Module

#### Switching Device Comparison Chart

	T-Stat	Solid State Relay	Watlow NO-ARC Relay
Amperage at 77°F (25°C)	10A	10A	10A
Amperage at 158°F (70°C)	10A	De-rate significantly and add heat sink and air cooling	10A
Output device life at 10A	Rated 100,000 at 158°F (70°C)	Greater than 10 million cycles at 77°F (25°C)	Greater than 4.5 million cycles at 158°F (70°C)

# Integrated Multi-Function

## SERIES EHG SL10

### Technical Information (Continued)

#### EHG SL10 Software

With the addition of an optional communication module, the EHG SL10 can be managed, monitored and manipulated via software. Change set points, label devices, change tuning parameters, check health status and much more all with the click of a key.

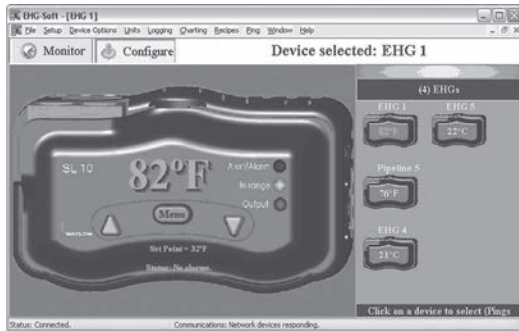

#### Reduces System Complexity and Cost

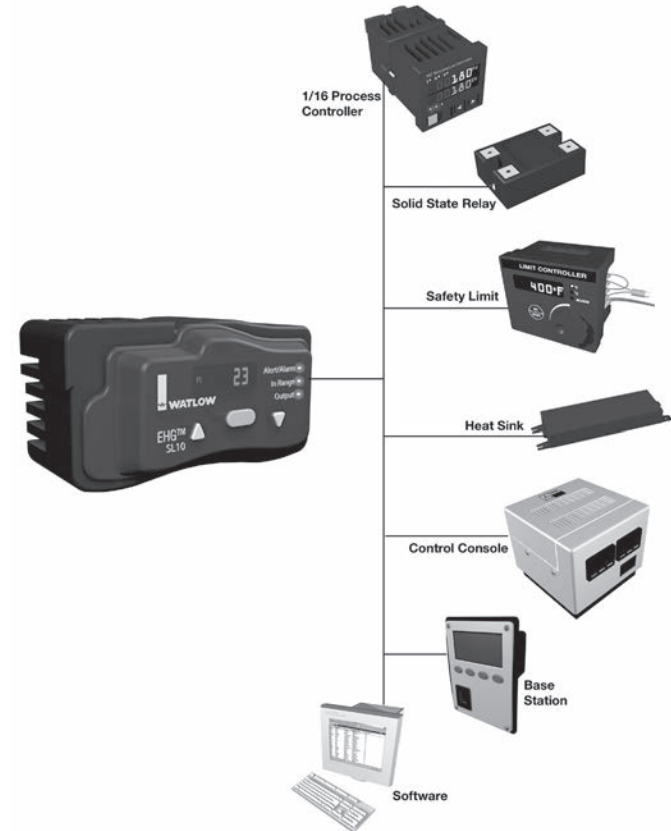

#### Mounting Bracket

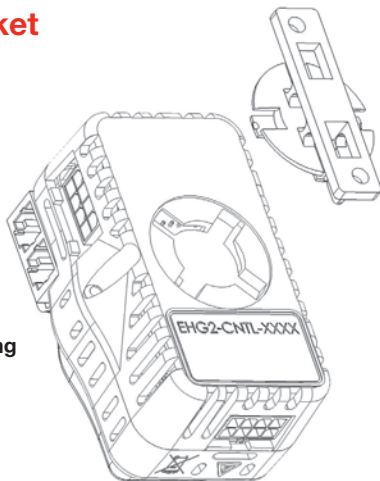

The EHG SL10 mounting bracket enables the controller to be mounted in four angles.

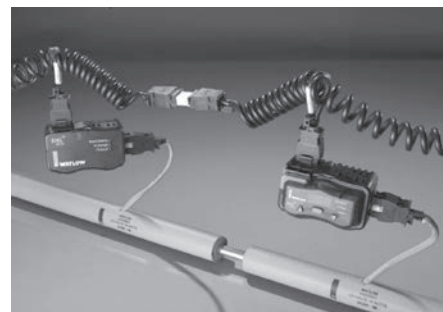

The EHG SL10 can be "daisy-chained" for gas line and other assemblies.





# Integrated Multi-Function

## SERIES EHG SL10

### Technical Information (Continued)

#### Optional Upgrade Modules

These upgrade modules are easy to install. There is no need to reconfigure, rewire or reorder the base unit. A technician is not needed for the installation, resulting in a seamless, cost-efficient system that can be upgraded.

		Diagnostics Memory Control Parameters	Ability to Change Temperature Parameters	Field Adjustable Set Point	3-Digit 7-Segment LED Display Illuminated	Diagnostic LED's	User Interface Software	Modbus® RTU Communication	RS-485
Base Unit		✓	✓			✓			
Optional Display Module		✓	✓	✓	✓	✓			
Optional Communication Module		✓	✓	✓		✓	✓	✓	✓
Optional Display and Communication Module		✓	✓	✓	✓	✓	✓	✓	✓

#### Ordering Information

##### Part Number

① ② ③ ④ ⑤ ⑥	⑦ ⑧ ⑨
265 EG2	Base/Module

⑦ ⑧ ⑨	Base/Module
001	Base unit
007	Display module
008	Communications module
002	Display with communications module
023	Base unit (extended temperature range)
020	Display module (extended temperature range)
022	Communications module (extended temperature range)
021	Display with communications module (extended temperature range)

#### Additional cables for wiring parallel heater circuits (daisy-chaining) in gas line and other assemblies

- 4800-0012 - Long cable
- 4800-0022 - Long terminating cable
- 4800-0011 - Short cable
- 4800-0021 - Short terminating cable

#### Compatible Accessories

##### Operator Interface Terminals (OIT)

Silver Series EM touchscreen operator interface terminals provide a customizable user interface, email event notifications and log and graph data for Watlow controllers and other devices. A Silver Series EM operator interface terminal paired with Watlow controllers is the perfect solution for industrial processes or machine control applications. See page 365.



# Integrated Multi-Function

## SERIES EHG

Many applications requiring a fixed temperature set point rely on a mechanical thermostat for thermal control. Thermostats have proven, however, to be inadequate for many applications due to long-term reliability issues, such as 100,000 cycle rating and poor temperature control.

The SERIES EHG thermal solution includes a compact temperature control, thermocouple sensor and power switching device integrated into the heater's power cord. The SERIES EHG reduces system costs and lasts substantially longer than a conventional thermostat solution.

The evolution of miniature microprocessor technology and Watlow switching technology fostered development of a small, versatile temperature control and thermocouple sensor that is integrated with Watlow silicone rubber heater products. This device senses the temperature via input from a thermocouple strategically placed on the heater mat. The microprocessor is programmed prior to shipment with an application specific set point. This results in quick delivery of a custom, integrated system.

The small thermocouple mass provides superior response to changes in process temperature enabling higher watt density silicone rubber heater designs. These features offer an integrated custom set point temperature controller with superior life span, faster heat-up rates and improved accuracy. The SERIES EHG System has been tested to over four million cycles at rated amperage. Depending on the application, Watlow's power switching design can last up to 40 times longer than a conventional thermostat.

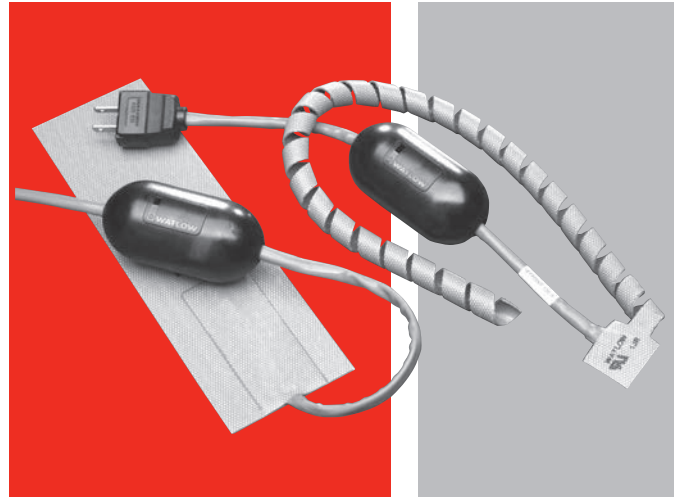

### Features and Benefits

#### Long operational life

- Improves system reliability

#### Tight temperature control

- Ensures process accuracy

#### Small sensor footprint

- Fits with almost any heater
- Responds quickly to temperature changes
- Controls high watt densities in low mass applications

#### Reduced system cost

- A single EHG control can be configured with multiple heaters

#### Pre-wired, in line control

- Simplifies installation
- Two wire power connection

#### Durable housing with built-in strain relief

- Protects electronics
- Low risk of mechanical damage

#### Manufactured with proven Watlow components

- Assures reliable system performance

# Integrated Multi-Function

## SERIES EHG

### Technical Information

#### Specifications

##### Operational

- SERIES EHG silicone rubber heater UL<sup>®</sup> recognized to 428°F (220°C) operating temperature
- Factory programmed fixed set point
- On-off control with 6°F (3°C) switching hysteresis
- Temperature band LED indicator ON between -68 and +68°F (-20 and +20°C) of set point

##### Electrical

- Voltage rating: 120 or 240VAC – 30/+10%, 50/60Hz
- Silicone rubber heater watt densities up to 80 W/in<sup>2</sup> (12.5 W/cm<sup>2</sup>) dependent on application temperature
- SERIES EHG system UL<sup>®</sup> recognized to 10A max.

##### Sensor

- Type K thermocouple

##### Mechanical

- Control dimensions 3.75 in. (95 mm) long by 1.75 in. (45 mm) diameter
- Heater per silicone rubber heater specifications

##### Agencies

- Silicone rubber heater: UL<sup>®</sup> recognized File #E52951
- SERIES EHG control: TUV File DE 3-3068 to EN 61010-1:2001, UL<sup>®</sup> File E43684 to UL<sup>®</sup> 873 temperature indicating and regulating equipment

##### Environmental

- Control operating temperature range 32 to 158°F (0 to 70°C)
- Control storage temperature range -40 to 158°F (-40 to 70°C)

Contact your Watlow representative for custom configurations.

### SERIES EHG Versus Thermostat (typical application)

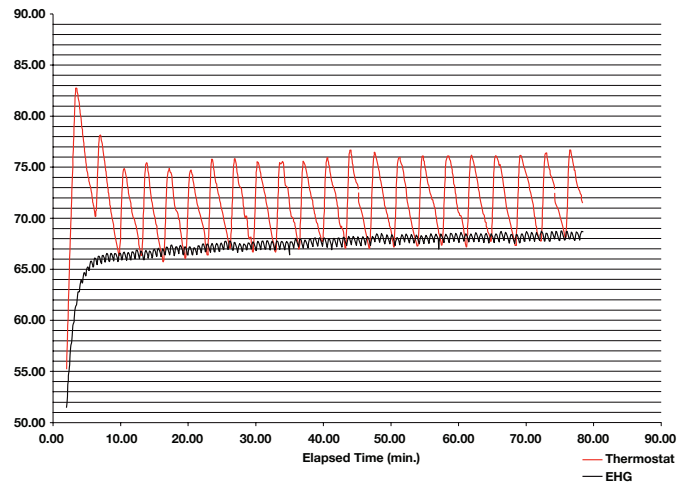

### Dimensions

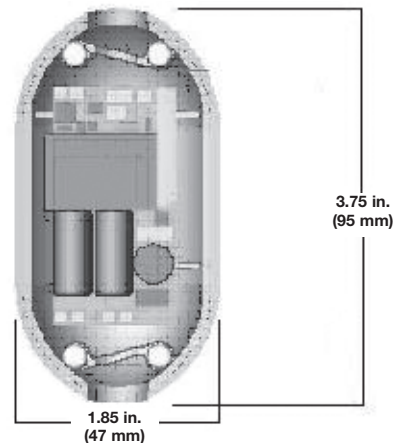

### Integrated SERIES EHG System Versus Integrated Thermostat System

	Integrated EHG System	Integrated Thermostat System	SERIES EHG Benefit
Life comparison at rated amperage 10A load	Tested to greater than 4,000,000 cycles with	Rated 100,000 cycles	Longer product life of SERIES EHG system and high application reliability
Switch hysteresis	6°F (3°C)	15°F (8°C)	Provides superior process control
Improved response time reduces overshoot on start-up	6°F (3°C) typical	25°F (14°C) typical	Responds to temperature changes faster than a thermostat
Warranty	2 years for material and workmanship	1 year on material and workmanship	Warranty can be extended due to longer life cycle
Zero Cross Switching	SERIES EHG has zero cross switching	Random switching during sign wave cycle	Reduces the possibility of electrical mechanical interference (EMI)





# Temperature and Process

Product	Control/ Limit Loops	Mounting	Fiber Optic Temp. Measure- ment	Profiling	Maximum Output	Communication Protocols	Page
<b>F4T with INTUITION®</b>	4/4	DIN-rail, Flush mount	–	✓	12A	Standard bus, Modbus® TCP (Ethernet), Modbus® RTU, SCPI, USB Host (2), USB device	<b>271</b>
<b>EZ-ZONE® RM</b>	152/192	DIN-rail	–	✓	15A	Standard bus, EtherNet/IP™, DeviceNet™, PROFIBUS DP, Modbus® TCP, Modbus® RTU	<b>272</b>
<b>EZ-ZONE RMF</b>	8/0	DIN-rail	✓	–	–	Standard bus, EtherNet/IP™, DeviceNet™, PROFIBUS DP, Modbus® TCP, Modbus® RTU	<b>273</b>
<b>EZ-ZONE RMZ</b>	48/0	DIN-rail	✓	–	–	EtherCAT® Standard bus, EtherNet/IP™, DeviceNet™, PROFIBUS DP, Modbus® TCP, Modbus® RTU	<b>273</b>
<b>EZ-ZONE ST</b>	1/1	DIN-rail	–	✓	75A	Standard bus, Modbus® RTU	<b>274</b>
<b>SERIES F4 Ramping</b>	2/0	1/4 DIN front panel	–	✓	2A	Modbus® RTU	<b>275</b>
<b>SERIES F4 Process</b>	2/0	1/4 DIN front panel	–	–	2A	Modbus® RTU	<b>281</b>
<b>EZ-ZONE PM</b>	2/1	1/32, 1/16, 1/8, 1/4 DIN front panel	–	✓	15A	Standard bus, EtherNet/IP™, DeviceNet™, PROFIBUS DP, Modbus® TCP, Modbus® RTU	<b>286</b>
<b>EZ-ZONE PM Express</b>	1/1	1/32, 1/16 DIN front panel	–	–	15A	Standard bus	<b>287</b>
<b>SERIES CV</b>	1/0	DIN-rail, Front panel, chassis	–	–	8A	N/A	<b>288</b>
<b>SERIES CF</b>	1/0	DIN-rail, Front panel, chassis	–	–	8A	N/A	<b>291</b>
<b>SERIES EHG® SL10</b>	1/1	In-line/ Sub panel	–	–	10A	Modbus® RTU	<b>294</b>
<b>SERIES EHG</b>	1/0	In-line	–	–	10A	N/A	<b>295</b>

**Note:** The specifications in the table above are best available values in each category. Not all combinations of these values are available in a single model number.



# Temperature and Process

## F4T with INTUITION®

The F4T with INTUITION® temperature process controller offers a wide range of field removable I/O modules for maximum design flexibility. Configurations can be custom tailored to meet the scaling needs of a tremendous range of equipment and applications while providing exactly the hardware types required for compatibility. The F4T controller also features a 4.3 inch, color, graphical touch panel. Combining power, flexibility and functionality, this new controller offers unmatched versatility, and its best-in-class ease of use could very well make user manuals a thing of the past.

### Features and Benefits

#### 4.3-inch, color touch panel with high-resolution, graphical user-interface

- Shortens learning curve and reduces operator errors
- Allows channels, profiles, alarms, inputs and outputs to be personalized with user defined names

#### Temperature PID, data logger, trend chart, over/under-temperature limit, power switching, math, logic, timers and counters combined into an integrated system

- Lowers ownership costs
- Eliminates the need for separate discrete components
- Reduces complexity
- Simplifies design, ordering and installation
- Saves money

#### Robust algorithms for temperature, cascade, altitude, humidity and compressor

- Improves process control
- Offers one to four channels of control
- Provides multiple PID sets
- Enables TRU-TUNE®+ adaptive control algorithm
- Offers 40 ramp and soak profiles with real-time clock and battery backup

#### COMPOSER® graphical configuration PC software

- Speeds up and simplifies commissioning
- Archives and documents controller setup
- Connects with controller easily via Ethernet

#### Many communications options available including Ethernet Modbus® TCP and SCPI and EIA-232/485 Modbus® RTU

- Offers two USB host ports and one device port
- Simplifies file transfers
- Connects easily



#### Modular design

- Adapts quickly to evolving requirements
- Offers numerous types of field pluggable modules for maximum flexibility and easiest compatibility
- Features scalable and modular firmware functions
- Delivers scalable input/output quantities from 1 to 36

#### Agency certifications include UL®, FM, CE, RoHS, W.E.E.E., NEMA 4X/IP65

- Ensures high quality and reliability
- Verifies performance in installations worldwide

#### SERIES F4S/F4D/F4P backward compatible

- Provides easy retrofit with minimum pain and disruption
- Ensures proper fit in existing SERIES F4 panel cutout

#### Off-the-shelf solution

- Provides cost-effective “make versus buy”
- Offers preconfigured touch-panel screens
- Assures quicker time to market

For detailed product and ordering information, see the full F4T product section located on pages **211 through 221.**

# Temperature and Process

## EZ-ZONE® RM

The EZ-ZONE® RM controller simplifies thermal system management. The EZ-ZONE RM controller family is comprised of six module types: an integrated on-off or PID control, monitoring and over/under temperature limit module, a high-density on-off or PID control module, a high-density limit only module, an input/output (I/O) expansion module, a high-density monitor/scanner module and a data logging and field communications access module. A system is configured by connecting any combination of module types to address specific application needs. The EZ-ZONE RM is extremely flexible and scalable allowing mixing and matching of I/O to configure 1 to 152 control loops and up to 256 monitor points.

### Optional integrated controller functions can be combined or ordered in different quantities:

- PID control loops
- Over/under temperature limit control loops
- 10 and 15 ampere power output/heater driver options
- On-board data logging
- Current measurement input
- Sequencer start up and control function
- Programmable timer and counter functions
- Programmable math and logic options
- Multiple communication protocol options
- Mobile configuration with removable secure digital (SD) flash card

### Benefits of using an integrated controller solution:

- Reduces wiring time and termination complexity compared with connecting multiple discrete products
- Improves system reliability
- Reduces termination and installation cost
- Eliminates compatibility issues often encountered with using various discrete components and brands
- Reduces troubleshooting time and downtime costs because the system can specifically identify any problems with a sensor, controller, solid state relay (SSR) power output or heater load
- Complete thermal solution saves engineering time and labor costs while shortening project schedules

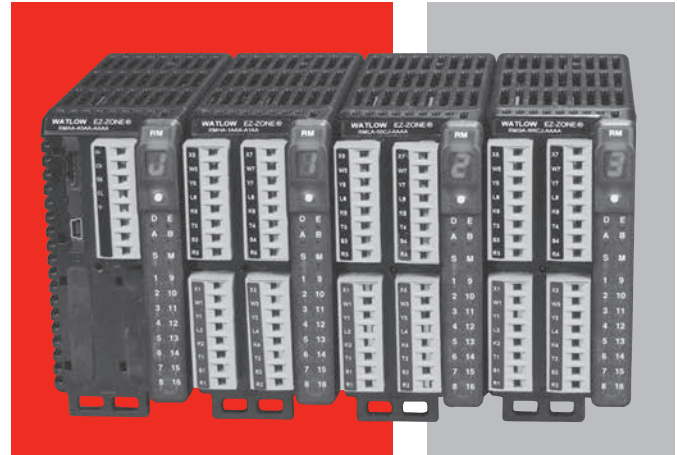

### Features and Benefits

#### Multiple inputs; from 1 to 152 PID loops of control or monitor up to 256 analog inputs

- Mix and match I/O to fit any application; from 1 input with 2 outputs to 152 analog inputs with 152 outputs, or monitor up to as many as 256 analog inputs all in one system
- Reduces cost because only required loops are purchased
- Allows a common controller platform across many design applications as both loops and outputs can be ordered in single increments

#### Advanced PID control algorithm

- Offers TRU-TUNE®+ adaptive control to provide tighter control for demanding applications
- Enables auto-tune for fast, efficient start-up

#### Communication capabilities

- Provides a range of protocol options including universal serial bus (USB) device port, Modbus® RTU, EtherNet/IP™, Modbus® TCP, DeviceNet™ and PROFIBUS

#### USB Port

- Provides data log retrieval

#### SPLIT-RAIL control

- Allows modules mounted in separate high-voltage and low-voltage cabinets to function as an integrated system
- Minimizes the length and cost of wire runs and improves system reliability by locating inputs closer to sensors and outputs closer to loads

**For detailed product and ordering information, see the full EZ-ZONE RM product section located on pages **222 through 239.****

# Temperature and Process

## EZ-ZONE® RMZ/RMF

By combining advances in fluorescent temperature sensing with the power of the proven EZ-ZONE® RM control system, Watlow® developed a best-in-class fiber optic temperature measurement and control system that will provide industry-leading performance for your specific application. By integrating fiber optic sensing capabilities into the EZ-ZONE RM control system, users will save space, improve performance with faster response times while simplifying their control system.

Watlow's EZ-ZONE RMZ and EZ-ZONE RMF make the system adaptable to all system requirements. Both are compatible with all other modules within the EZ-ZONE RM family and self-discover all existing modules within the system making a seamless integration into your temperature control/logic system.

### EZ-ZONE RMZ Offers Fiber Optic Sensing Capabilities and EtherCAT® Communications

The EZ-ZONE RMZ integrates fiber optics, PID temperature control and EtherCAT® communications into a single package. It features multi-channel control, hosting up to four channels of fiber optic inputs as well as supporting up to 44 additional control loops from other EZ-ZONE RM modules. These modules support a wide array of capabilities including I/O, logic, current measurement, power switching and more.

### EZ-ZONE RMF Offers Additional Fiber Optic Inputs for Expansion Opportunities

The EZ-ZONE RMF module is a dedicated fiber optic input module integrating the advanced control technology of the EZ-ZONE system with one to eight channels of fiber optic temperature sensing.

The EZ-ZONE RMF can also serve as additional inputs to the EZ-ZONE RMZ enabling extensive expansion opportunities for future system needs. The EZ-ZONE RMF is ideal either as an expansion module or configured with built-in temperature control loops (outputs via EZ-ZONE RME module). The EZ-ZONE RMF can be used independently when only sensing is required.



### Benefits of Watlow's high-performance fluorescence-based temperature measurement system include:

- Compact integrated fiber optic sensing with temperature control
- Easily expands to increase number of zones as your system needs increase
- Integrates seamlessly with the temperature control system avoiding additional analog signal processing
- Faster temperature sampling rates with high resolution
- Minimizes installed footprint due to the small form factor and DIN-rail mounting
- Highly accurate fluorescent signal processing electronics
- Offers highly reliable LED light source designed to run at low currents for maximum life
- Up to 48 loops of input and control with all EZ-ZONE RM temperature control features
  - Temperature / limit loops
  - Current measurement
  - Power switching
  - Logic

**For detailed product and ordering information, see the full RMZ/RMF product section located on pages 240 through 241.**

# Temperature and Process

## EZ-ZONE ST

The EZ-ZONE ST integrated solid state controller from Watlow offers a complete thermal system control solution in a single package. Features include a PID temperature controller connected to a high-amperage solid state relay with the option of adding a properly sized heat sink, an over- and under-temperature limit, a power shut-down contactor and digital communications in one complete and professionally engineered product.

Because the system is modular and scalable, a user only pays for what is needed. Stacking the EZ-ZONE ST integrated controller into multiple configurations enables flexibility to standardize the product platform to solve a wide range of application needs.

This integrated controller also includes 200KA short circuit current rating (SCCR) tested up to 480VAC to minimize damage in the event of a short circuit when used with required fusing.

### Features and Benefits

#### Back panel or DIN-rail mount

- Provides several mounting options

#### Compact package

- Reduces panel size

#### Touch-safe package

- Complies with IP2X increasing user safety

#### ±0.1 percent temperature accuracy

- Provides efficient and accurate temperature control

#### 200KA SCCR with proper fusing

- Minimizes damage in the event of a short circuit

#### Agency approvals: UL®, CSA, CE, RoHS, W.E.E.E.

- Meets applications requiring agency approvals

#### Three-year warranty

- Ensures Watlow's reliability and product support

#### Off-the-shelf designed system solution

- Improves system reliability and termination reduction
- Reduces installation cost
- Eliminates incompatibility headaches often encountered with using many different components and brands

#### Profile capability

- Includes ramp and soak with four files and 40 total steps

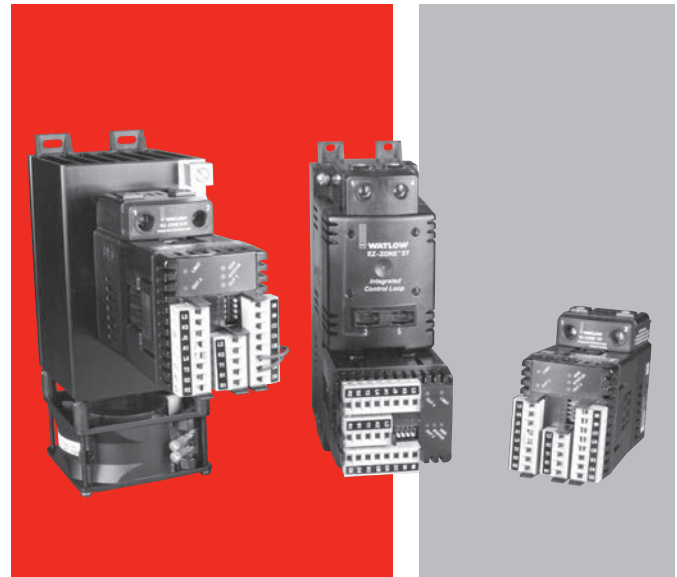

#### Ability to communicate with programmable logic controller (PLC), personal computer (PC) or operator interface terminal (OIT)

- Optional EIA-485 Modbus® RTU
- RUI/communications gateway with optional EIA-232/485 Modbus® RTU, EtherNet/IP™/TCP Modbus®, DeviceNet™ or PROFIBUS DP. Refer to page 371 for further information.

#### Solid state relay output

- Allows faster cycling, more precise control, increased heater life and improves energy efficiency
- Ability to handle up to 75 amperes
- Uses either zero-cross or phase angle control modes for flexibility to control resistive loads such as nichrome, tungsten or quartz lamps
- Utilizes phase angle control mode to prevent load failure or blowing fuses for tungsten or quartz loads

#### PID temperature control

- Allows single input/dual output
- Allows standard PID or adaptive TRU-TUNE+ tuning algorithms for demanding controllability requirements

#### Optional temperature limit

- Increases safety in over- and under-temperature condition

#### Optional definite purpose mechanical contactor

- Enables circuit safety shut down driven by limit control or PID alarm output signal

For detailed product and ordering information, see the full EZ-ZONE ST product section located on pages **242 through 248.**

# Temperature and Process

## SERIES F4 Ramping

The SERIES F4 1/4 DIN industrial ramping controller meets the requirements of the most demanding ramp and soak processing applications. Easy to set up and operate, its programming features and proven performance capabilities are ideally suited for environmental chamber or furnace and oven applications. Single and dual channel versions are available.

Competitively-priced, the SERIES F4 ramping controller features a four line, high-definition LCD interface display for quick and easy profile programming and controller configuration. Its 16-bit microprocessor ensures accuracy and delivers performance advantages you can count on from a Watlow controller.

Up to 256 steps can be programmed into as many as 40 nameable profiles that can be programmed to wait for events or for up to three different process variables. A guaranteed soak feature allows a setting for how closely to control a process.

Program the four digital event inputs to remotely start, pause or terminate any preprogrammed process recipes. Eight event outputs are segment programmable and three outputs can be assigned to a programmable compressor and boost heat/boost cool control. A real-time clock can start a profile at any time.

Serial communication and dual alarm relays are included in the base unit. The SERIES F4 ramping controller is packaged with a NEMA 4X front face to withstand harsh environments and a four in. (102 mm) deep case with removable connectors for wiring convenience. It is manufactured by Watlow, ISO 9001 registered and protected by a three-year warranty.



### Features and Benefits

#### Guided 256 step, 40 profile ramp and soak programmable memory

- Supports a wide range of processing applications

#### High-definition, four line LCD controller interface display

- Simplifies setup and operation

#### Menu customization

- Offers enhanced process monitoring

#### High-performance, 16-bit microprocessor

- Precise process control

#### Universal inputs

- Provides application versatility

#### Expandable modular construction

- Field upgradable

#### Enhanced environmental chamber control

- Supports humidity, compressor, boost heat/boost cool control

#### Cascade control

- Provides precise two variable control

#### Real-time clock with battery backup

- Offers operational flexibility

# Temperature and Process

## SERIES F4 Ramping

### Set Point Ramp and Soak Programming

In response to customer needs, the Watlow SERIES F4 ramping controller has been enhanced with programming features that offer more capabilities with less programming complexity.

A programming guide provides step-by-step instructions for building profiles, offering choices for step configuration. For better operator recognition, profiles and digital I/O used for events can be named using up to 10 characters.

Five step types including ramp, soak, jump, auto start and end, offer complete programming flexibility.

Ramp steps can be based on time or rate. Ramp and soak steps can be programmed to wait for up to four event inputs and three process variables. As many as eight event outputs are step selectable. To accommodate changes to thermal systems characteristics over the operating range, up to 10 sets of PID heat/cool parameters are step selectable. The auto start step can start a profile based on a chosen set date, day of the week or daily. A jump step enables movement within a profile or to another profile. The end step terminates a program with the control outputs programmed to specific process needs.

### Temperature and Humidity Chamber Application

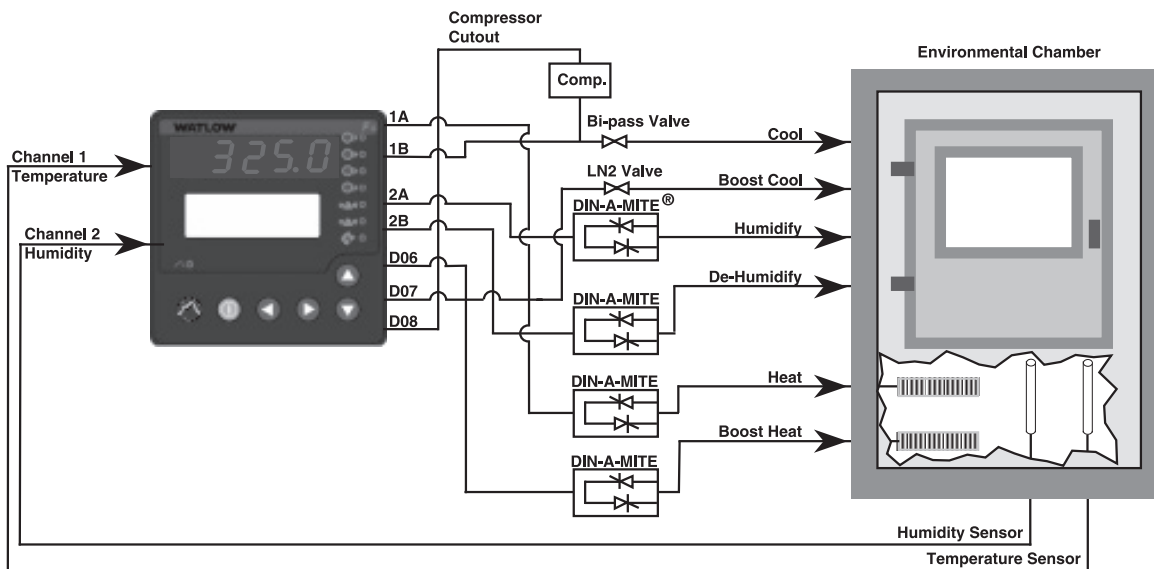

### Serial Communication

EIA-232 and EIA-485 serial communication interfaces are included in the base unit of both the SERIES F4S (single channel) and the SERIES F4D (dual channel) controllers. The baud rate is selectable as either 9600 or 19200 Kbaud. The protocol is Modbus® RTU.

### Alarms

Two Form "C" electromechanical alarm relays are included in the base units. These alarms can be programmed as either process or deviation alarms. The alarms can be tied to up to three process variables.

### Optional Retransmit

Optional retransmit capability is available to retransmit one or two variables. These variables include up to three process variables, control set points or percent load power.

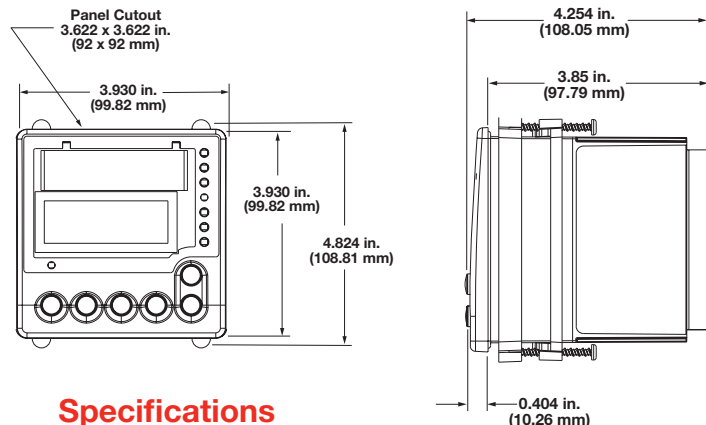

### Specifications

#### Dimensions

- Width x height x depth  
3.93 in. x 3.93 in. x 3.85 in. (99 mm x 99 mm x 97 mm) panel mount



# Temperature and Process

## SERIES F4 Ramping

### Specifications

#### Universal Analog Inputs 1 (2 and 3 Optional)

- Updates rates, IN1 = 20Hz, IN2 and IN3 = 10Hz

#### Thermocouple

- Type J, K, T, N, E, C (W5), D (W3), PTII, R, S, B
- Input impedance 20M $\Omega$

#### RTD

- 2- or 3-wire platinum, 100, 500 or 1000 $\Omega$
- JIS or DIN curves, 1.0 or 0.1 indication

#### Process

- Input resolution  $\approx$ 50,000 bits at full scale
- Range selectable: 0-10VDC, 0-5VDC, 1-5VDC, 0-50mV, 0-20mA, 4-20mA
- Voltage input impedance 20K $\Omega$
- Current input impedance 100 $\Omega$

#### Digital Inputs (4)

- Update rate = 10Hz
- Contact or dc voltage (36VDC max.)
- 10K $\Omega$  input impedance

#### Control Outputs (1A, 1B, 2A, 2B)

- Update rate = 20Hz

#### Open Collector/Switched dc

- Internal load switching (nominal):  
Switched dc, 22 to 28VDC, limited @ 30mA
- External load switching (max.):  
Open collector 42VDC @ 0.5A

#### Solid State Relay

- Zero switched, optically coupled, 0.5A @ 24VAC min., 253VAC max.

#### Process Outputs (Optional Retransmit)

- Update rate = 1Hz
- User selectable 0-10VDC, 0-5VDC, 1-5VDC @ 1K $\Omega$  min., 0-20mA, 4-20mA @ 800 $\Omega$  max.
- Resolution:  
dc ranges = 2.5mV nominal  
mA ranges = 5 $\mu$ A nominal
- Calibration accuracy:  
dc ranges =  $\pm$ 15mV  
mA ranges =  $\pm$ 30 $\mu$ A
- Temperature stability 100ppm/ $^{\circ}$ C

#### Alarm Outputs

- Output update rate 1Hz
- Electromechanical relay, Form C, 2A @ 30VDC or 240VAC max.

#### Digital Outputs (8)

- Update rate = 10Hz
- Open collector output
- Off = 42VDC max. @ 10 $\mu$ A
- On = 0.2VDC max. @ 50mA sink
- Internal supply: 5VDC, @ 80mA

#### Communications

EIA-232 and EIA-485 serial communications with Modbus<sup>®</sup> RTU protocol

#### Safety and Agency Approvals

- UL<sup>®</sup>/C-UL<sup>®</sup> 916 listed, File #E185611

#### Process Control Equipment

- CE
  - EN 61010-1
  - EN 61326
  - IP65 and NEMA 4X

#### Terminals

- Touch-safe, removable terminal blocks, accepts 12 to 22 gauge wire

#### Power

- 100-240VAC, -15%, +10%; 50/60Hz,  $\pm$ 5%
- 39VA max. power consumption
- Data retention upon power failure via nonvolatile memory (7 years for battery backed RAM)
- Sensor input isolation from input to input to output to communication circuitry is 500VAC

#### Operating Environment

- 32 to 130 $^{\circ}$ F (0 to 55 $^{\circ}$ C)
- 0 to 90% RH, non-condensing
- Storage temperature: -40 to 158 $^{\circ}$ F (-40 to 70 $^{\circ}$ C)

#### Accuracy

- Calibration accuracy and sensor conformity:  $\pm$ 0.1% of span  $\pm$ 1 $^{\circ}$ C @ 77 $^{\circ}$ F  $\pm$ 5 $^{\circ}$ F (25 $^{\circ}$ C  $\pm$ 3 $^{\circ}$ C) ambient and rated line voltage  $\pm$ 10% with the following exceptions:
  - Type T: 0.12% of span for -328 to -58 $^{\circ}$ F (-200 to -50 $^{\circ}$ C)
  - Types R and S: 0.15% of span for 32 to 212 $^{\circ}$ F (0 to 100 $^{\circ}$ C)
  - Type B: 0.24% of span for 1598 to 3092 $^{\circ}$ F (870 to 1700 $^{\circ}$ C)
- Accuracy span: Less than or equal to operating ranges, 1000 $^{\circ}$ F (540 $^{\circ}$ C) min.
- Temperature stability:  $\pm$ 0.1 $^{\circ}$ F/ $^{\circ}$ F ( $\pm$ 0.1 $^{\circ}$ C/ $^{\circ}$ C) rise in ambient for thermocouples  
 $\pm$ 0.05 $^{\circ}$ F/ $^{\circ}$ F ( $\pm$ 0.05 $^{\circ}$ C/ $^{\circ}$ C) rise in ambient for RTD sensors

# Temperature and Process

## SERIES F4 Ramping

### Specifications (Continued)

#### Displays

- Process: 5 digit, 7 segment LED, red
- Control interface display: 4-row, 20-character high definition LCD green

#### Sensor Operating Ranges

Type J:	32	to	1500°F	or	0	to	815°C
Type K:	-328	to	2500°F	or	-200	to	1370°C
Type T:	-328	to	750°F	or	-200	to	400°C
Type N:	32	to	2372°F	or	0	to	1300°C
Type E:	-328	to	1470°F	or	-200	to	800°C
Type C (W5):	32	to	4200°F	or	0	to	2315°C
Type D (W3):	32	to	4352°F	or	0	to	2400°C
Type Pt 2:	32	to	2543°F	or	0	to	1395°C
Type R:	32	to	3200°F	or	0	to	1760°C
Type S:	32	to	3200°F	or	0	to	1760°C
Type B:	32	to	3300°F	or	0	to	1816°C
RTD (DIN):	-328	to	1472°F	or	-200	to	800°C
RTD (JIS):	-328	to	1166°F	or	-200	to	800°C
Process:	-19,999 to 30,000 units						

#### Sensor Accuracy Ranges

##### Input ranges

Type J:	32	to	1382°F	or	0	to	750°C
Type K:	-328	to	2282°F	or	-200	to	1250°C
Type T:	-328	to	662°F	or	-200	to	350°C
Type N:	32	to	2282°F	or	0	to	1250°C
Type E:	-328	to	1470°F	or	-200	to	800°C
Type C (W5):	32	to	4200°F	or	0	to	2315°C
Type D (W3):	32	to	4352°F	or	0	to	2400°C
Type Pt 2:	32	to	2540°F	or	0	to	1393°C
Type R:	32	to	2642°F	or	0	to	1450°C
Type S:	32	to	2642°F	or	0	to	1450°C
Type B:	1598	to	3092°F	or	870	to	1700°C
RTD (DIN):	-328	to	1472°F	or	-200	to	800°C
RTD (JIS):	-328	to	1166°F	or	-200	to	630°C
Process:	-19,999 to 30,000 units						

**Note:** Specifications subject to change without notice.

# Temperature and Process

## SERIES F4 Ramping

### Ordering Information - 1/4 DIN Single Channel Ramping Controller

#### Part Number

<b>1 2</b>	<b>3</b>	<b>4</b>	<b>5</b>	<b>6</b>	<b>7</b>	<b>8</b>	<b>9</b>	<b>10</b>	<b>11 12</b>
	Single Channel Ramping	Power Supply	Output 1A	Output 1B		Auxiliary Input Module	Auxiliary Retransmit Module	Language and RTD Options	Display and Custom Options
<b>F4</b>	<b>S</b>		-		<b>A</b>		-		

<b>3</b> Single Channel Ramping Controller	
S =	1 universal analog input, 4-digital inputs, 8-digital outputs, 2 alarms, EIA-232/485 comms

<b>4</b> Power Supply	
H =	100-240VAC/VDC

<b>5</b> Output 1A	
C =	Open collector/switched dc
F =	Process, 0-5, 1-5, 0-10VDC, 0-20mA, 4-20mA
K =	Solid state Form A 0.5A relay

<b>6</b> Output 1B	
A =	None
C =	Open collector/switched dc
F =	Process, 0-5, 1-5, 0-10VDC, 0-20mA, 4-20mA
K =	Solid state Form A 0.5A relay

<b>8</b> Auxiliary Input Module	
0 =	None
6 =	Dual universal inputs

<b>9</b> Auxiliary Retransmit Module	
0 =	None
1 =	Single retransmit output 0-5, 1-5, 0-10VDC, 0-20mA, 4-20mA
2 =	Dual retransmit outputs 0-5, 1-5, 0-10VDC, 0-20mA, 4-20mA

<b>10</b> Language and RTD Option	
1 =	English with 100Ω RTD
2 =	German with 100Ω RTD
3 =	French with 100Ω RTD
4 =	Spanish with 100Ω RTD
5 =	English with 500 and 1KΩ RTD
6 =	German with 500 and 1KΩ RTD
7 =	French with 500 and 1KΩ RTD
8 =	Spanish with 500 and 1KΩ RTD

<b>11 12</b> Display and Custom Options	
RG =	Standard display (Red/Green display only)
XX =	Custom options: software, setting parameters, overlay

# Temperature and Process

## SERIES F4 Ramping

### Ordering Information - 1/4 DIN Dual Channel Ramping Controller

#### Part Number

①	②	③	④	⑤	⑥	⑦	⑧	⑨	⑩	⑪ ⑫
Dual Channel Ramping		Power Supply	Output 1A	Output 1B	Output 2A	Output 2B	Auxiliary Retransmit Module	Language and RTD Options	Display and Custom Options	
F4		D	-				-			

③ Dual Channel Ramping Controller
D = 3 universal analog inputs, 4-digital inputs, 8-digital outputs, 2 alarms, EIA-232/485 comms

④ Power Supply
H = 100-240VAC/VDC

⑤ Output 1A
C = Open collector/switched dc
F = Process, 0-5, 1-5, 0-10VDC, 0-20mA, 4-20mA
K = Solid state Form A 0.5A relay

⑥ Output 1B
A = None
C = Open collector/switched dc
F = Process, 0-5, 1-5, 0-10VDC, 0-20mA, 4-20mA
K = Solid state Form A 0.5A relay

⑦ Output 2A
C = Open collector/switched dc
F = Process, 0-5, 1-5, 0-10VDC, 0-20mA, 4-20mA
K = Solid state Form A 0.5A relay

⑧ Output 2B
A = None
C = Open collector/switched dc
F = Process, 0-5, 1-5, 0-10VDC, 0-20mA, 4-20mA
K = Solid state Form A 0.5A relay

⑨ Auxiliary Retransmit Module
0 = None
1 = Single retransmit output 0-5, 1-5, 0-10VDC, 0-20mA, 4-20mA
2 = Dual retransmit outputs 0-5, 1-5, 0-10VDC, 0-20mA, 4-20mA

⑩ Language and RTD Option
1 = English with 100Ω RTD
2 = German with 100Ω RTD
3 = French with 100Ω RTD
4 = Spanish with 100Ω RTD
5 = English with 500 and 1KΩ RTD
6 = German with 500 and 1KΩ RTD
7 = French with 500 and 1KΩ RTD
8 = Spanish with 500 and 1KΩ RTD

⑪ ⑫ Display and Custom Options
RG = Standard display (Red/Green display only)
XX = Custom options: software, setting parameters, overlay

## Compatible Accessories

### Operator Interface Terminals (OIT)

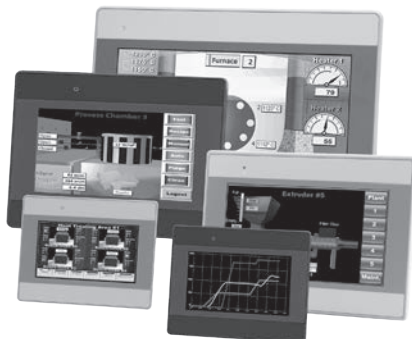

Silver Series EM touchscreen operator interface terminals provide a customizable user interface, email event notifications and log and graph data for Watlow controllers and other devices. A Silver Series EM operator interface terminal paired with Watlow controllers is the perfect solution for industrial processes or machine control applications. See page 365.

### SpecView



SpecView is designed for industrial users and includes features such as data logging, trending and support for bar code readers and touch screens. Errors are reduced for any process by creating application-specific screens. The software provides a historical replay option, easy-to-use recipe features and remote access options, including LAN, Internet and modem. See page 385.

# Temperature and Process

## SERIES F4 Process

The SERIES F4 1/4 DIN temperature process controller offers performance features to meet a wide range of industrial processing needs. The F4 process controller is ideal for semiconductor manufacturing equipment, plastic processing and packaging equipment and industrial process control applications.

This controller features a four line, high definition LCD interface display, in addition to an information key that enables easy set up and control operation, minimizing the chance for error. Its 16-bit microprocessor ensures accuracy and delivers performance advantages you can count on from a Watlow controller.

Four digital inputs remotely modify controller operation or enable display of pre-defined operator messages. Advanced features include cascade, ratio, differential, duplex slide wire and retransmit options.

Serial communication and dual alarm relays are included in the base unit. The SERIES F4 is packaged with a NEMA 4X front face to withstand harsh environments and a four-inch (101.6 mm) deep case with removable connectors for wiring convenience. It is manufactured by Watlow, ISO 9001 registered and protected by a three-year warranty.



### Features and Benefits

#### Guided set-up

- Removes “guess work” from the set-up process
- Saves time by reducing programming errors

#### High definition four-line LCD display

- Simplifies set up process and operations
- Quickly and easily identifies process, alarm and set point values

#### Information “I” Key

- Displays essential elements from the user manual on board

#### Customized menuing

- Quickly displays up to 16 parameters
- Allows users to create custom messaging and easily identify key events or alarms

#### High performance 16-bit microprocessor

- Provides precise process control with 20Hz update rate on input 1. (10Hz on inputs 2 and 3)
- Calibration accuracy of  $\pm 0.1$  percent of span

#### Universal input

- Embedded software provides application versatility
- Eliminates the need for dip switches

#### Modbus® communications ready

- Equipped to handle RS232 or EIA-485 communications

# Temperature and Process

## SERIES F4 Process

### General Purpose Control Operation

The SERIES F4 temperature process controller with a single channel PID controller supports either closed or open loop operation. The design utilizes the latest technology to meet complex processing needs while maintaining an easily understood operator interface.

Full, non-abbreviated parameter choices are displayed using a four line, high-definition LCD interface display that is back lit for wide angle viewing. Firmware guides the operator through parameter choices for feature configuration. An information key (I) provides the operator with detailed help information regarding the parameter or feature being configured. The main page menu can be programmed to display output power through 16 control variables including: bar graphs, set points and operating ranges. Up to four programmable messages can be activated remotely to inform the operator that the process requires attention.

Five sets of PID values can be auto-tuned to support varying system reactions over the complete operating range. Up to 10 offset points can be programmed to compensate for differences between the actual process value and sensor readings caused by sensor placement.

### Control Inputs

Up to three universal analog inputs are configured through software to support thermocouples, RTDs and process (voltage/current) sensors. Auxiliary inputs 2 and 3 can function as a remote set point input, sources for retransmission or as the outer loop for cascade operation.

### Digital Inputs

Four inputs are programmable and can remotely modify controller operation and display pre-programmed messages on the operations display.

### Control Outputs

Heat/cool or reverse/direct action is supported. Time based outputs can be configured for variable burst fire or a cycle time can be selected. On-off boost heat or boost cool operation is also supported. Boost operation is enabled based on load power requirements.

### Alarms

Two alarms are included in the base unit and can be programmed as process, deviation or rate.

### Serial Communications

Both EIA-232 and EIA-485 communications are included in the base unit. The SERIES F4 operates via the Modbus® RTU protocol and responds to requests for information only when queried. Baud rate selections are 9600 or 19200.

### Retransmit

Up to two optional programmable voltage or current signal retransmit outputs are supported. Retransmit sources include up to three process variables; set point and output percent power.

# Temperature and Process

## SERIES F4 Process

### Enhanced Control Operation

An enhanced operation option for the SERIES F4 process controller includes additional universal analog inputs (inputs 2 and 3) and enhanced firmware to support several features that utilize the two additional inputs. The enhanced control option can be configured to support cascade control, (see the application diagram below), differential control, ratio control and slide wire valve control. The enhanced control option can also alternate between control inputs, display up to three process variables and support remote set point operation.

In this sample application, the SERIES F4 process controller uses the enhanced cascade control feature to heat lube oil to 51.6°C (125°F). Cascade control is a control strategy in which one control loop provides the set point for another loop. It allows the process or part temperature to be reached quickly while minimizing overshoot. Cascade is used to optimize thermal system performance with long lag times. Input 3 measures the lube oil temperature before it leaves the tank. Input 1 measures the heater temperature. The input 3 process value is compared to the set point which generates an internal set point used to control the heater.

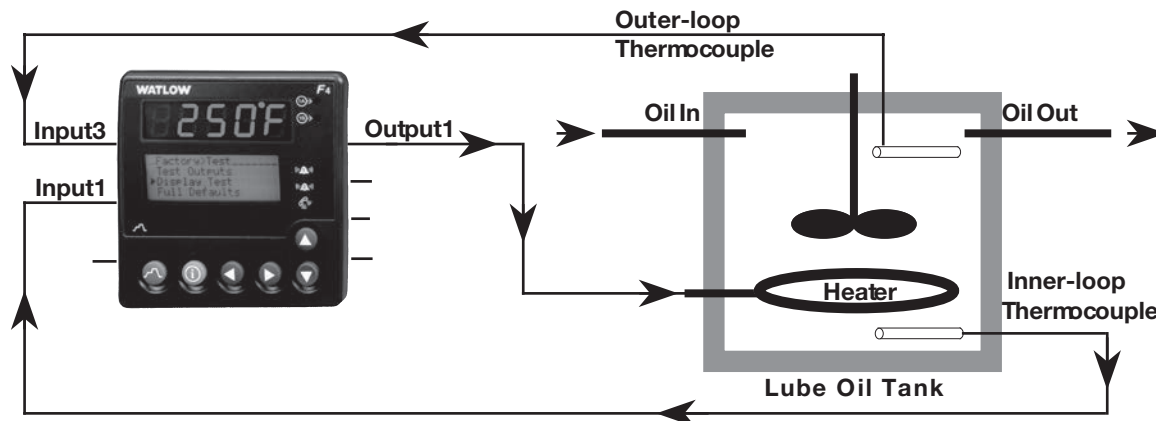

### Specifications

#### Universal Analog Inputs 1 (2 and 3 optional)

- Update rates, IN1 = 20Hz, IN2 and IN3 = 10Hz

#### Thermocouple

- Type J, K, T, N, C (W5), E, Pt 2, D (W3), B, R, S

#### RTD

- 2- or 3-wire platinum, 100, 500, or 1K $\Omega$
- JIS or DIN curves, 1.0 or 0.1 indication

#### Process

- Input resolution  $\approx$  50,000 bits at full scale
- Range selectable: 0-10VDC, 0-5VDC, 1-5VDC, 0-50mV, 0-20mA, 4-20mA
- Voltage input impedance 20K $\Omega$
- Current input impedance 100 $\Omega$

#### Digital Inputs (4)

- Update rate = 10Hz
- Contact or dc voltage; 36VDC max
- 10K $\Omega$  input impedance

#### Control Outputs (1A, 1B)

- Update rate = 20Hz

#### Open Collector/Switched dc

- Internal load switching (nominal):  
Switched dc, 22 to 28VDC, limited @ 30mA
- External load switching max.:  
Open collector 42VDC @ 0.5A

#### Solid-state Relay

- Zero switched, optically coupled, 0.5A @ 24VAC min., 253VAC max.

#### Electromechanical Relay

- Form C, 2A @ 250VAC or 30VDC max.
- Resistive or inductive load
- Without contact suppression

#### Process Outputs (Optional Retransmit)

- Update rate = 1Hz
- User-selectable 0-10VDC, 0-5VDC, 1-5VDC @ 1K $\Omega$  min., 0-20mA, 4-20mA @ 800 $\Omega$  max.
- Resolution:  
dc ranges = 2.5mV nominal  
mA ranges = 5 $\mu$ A nominal
- Calibration accuracy:  
dc ranges =  $\pm$ 15mV  
mA ranges =  $\pm$ 30 $\mu$ A
- Temperature stability 100ppm/ $^{\circ}$ C

# Temperature and Process

## SERIES F4 Process

### Alarm Outputs

- Output update rate 1Hz
- Electromechanical relay, Form C, 2A @ 30VDC or 240VAC max.

### Communications

- EIA-232 and EIA-485 serial communications with Modbus® RTU protocol

### Safety and Agency Approvals

- UL®/C-UL® 916 listed, File # E185611 Process Control Equipment
- NEMA 4X and IP65
- CE to EN 61010-1 and 61326

### Terminals

- Touch-safe, removable terminal blocks, accepts 12 to 22-gauge wire

### Power

- 100-240VAC, -15%, +10%; 50/60Hz,  $\pm 5\%$
- 39VA max. power consumption
- Data retention upon power failure via nonvolatile memory. Sensor input isolation from input to input to output to communication circuitry is 500VAC

### Operating Environment

- 32 to 149°F (0 to 65°C)
- 0 to 90% RH, non-condensing
- Storage temperature: -40 to 158°F (-40 to 70°C)

### Accuracy

- Calibration accuracy and sensor conformity:  $\pm 0.1\%$  of span  $\pm 1^\circ\text{C}$  @ 77°F  $\pm 5^\circ\text{F}$  ( $25^\circ\text{C} \pm 3^\circ\text{C}$ ) ambient, and rated line voltage  $\pm 10\%$  with the following exceptions:
  - Type T: 0.12% of span for -328 to -58°F (-200 to -50°C)
  - Types R and S: 0.15% of span for 32 to 212°F (0 to 100°C)
  - Type B: 0.24% of span for 1598 to 3092°F (870°C to 1700°C)
- Accuracy span: less than or equal to operating ranges, 1000°F (540°C) min.
- Temperature stability:  $\pm 0.1^\circ\text{F}/^\circ\text{F}$  ( $\pm 0.1^\circ\text{C}/^\circ\text{C}$ ) rise in ambient for thermocouples
- $\pm 0.05^\circ\text{F}/^\circ\text{F}$  ( $\pm 0.05^\circ\text{C}/^\circ\text{C}$ ) rise in ambient for RTD sensors

### Displays

- Process: 5 digit, 7 segment LED, red
- Control interface display: 4-row, 20-character high definition LCD green

### Sensor Operating Ranges

Type J:	32	to	1500°F	or	0	to	815°C
Type K:	-328	to	2500°F	or	-200	to	1370°C
Type T:	-328	to	750°F	or	-200	to	400°C
Type N:	32	to	2372°F	or	0	to	1300°C
Type E:	-328	to	1470°F	or	-200	to	800°C
Type C:	32	to	4200°F	or	0	to	2315°C
Type D:	32	to	4352°F	or	0	to	2400°C
Type Pt 2:	32	to	2543°F	or	0	to	1395°C
Type R:	32	to	3200°F	or	0	to	1760°C
Type S:	32	to	3200°F	or	0	to	1760°C
Type B:	32	to	3300°F	or	0	to	1816°C
RTD (DIN):	-328	to	1472°F	or	-200	to	800°C
RTD (JIS):	-328	to	1166°F	or	-200	to	800°C
Process:	-19,999 to 30,000 units						

### Sensor Accuracy Ranges

#### Input ranges

Type J:	32	to	1382°F	or	0	to	750°C
Type K:	-328	to	2282°F	or	-200	to	1250°C
Type T:	-328	to	662°F	or	-200	to	350°C
Type N:	32	to	2282°F	or	0	to	1250°C
Type E:	-328	to	1470°F	or	-200	to	800°C
Type C(W5):	32	to	4200°F	or	0	to	2315°C
Type D(W3):	32	to	4352°F	or	0	to	2400°C
Type Pt 2:	32	to	2540°F	or	0	to	1393°C
Type R:	32	to	2642°F	or	0	to	1450°C
Type S:	32	to	2642°F	or	0	to	1450°C
Type B:	1598	to	3092°F	or	870	to	1700°C
RTD (DIN):	-328	to	1472°F	or	-200	to	800°C
RTD (JIS):	-328	to	1166°F	or	-200	to	630°C
Process:	-19,999 to 30,000 units						



# Temperature and Process

## SERIES F4 Process

### Ordering Information

#### Part Number

① ②	③	④	⑤	⑥	⑦	⑧	⑨	⑩	⑪ ⑫
F4	Temperature /Process Controller P	Power Supply	Output 1A	Output 1B	A	Enhanced Control Operation	Auxiliary Retransmit Module	Language and RTD Options	Display and Custom Options

③ Temperature/Process Controller	
P =	Single channel temperature/process controller, two alarms, EIA-232/485 comms. four event inputs

④ Power Supply	
H =	100-240VAC/VDC

⑤ Output 1A	
C =	Open collector/switched dc
E =	Electromechanical relay, Form C 2A without contact suppression
K =	Solid state Form A 0.5A relay without contact suppression
F =	Process, 0-5, 1-5, 0-10VDC, 0-20mA, 4-20mA

⑥ Output 1B	
A =	None
E =	Electromechanical relay, Form C 2A without contact suppression
C =	Open collector/switched dc
K =	Solid state Form A 0.5A relay without contact suppression
F =	Process, 0-5, 1-5, 0-10VDC, 0-20mA, 4-20mA

⑧ Enhanced Control Operation	
A =	Standard control operation
B =	Enhanced control operation, dual universal inputs, cascade, ratio, duplex, differential, slidewire

⑨ Auxiliary Retransmit Module	
0 =	None
1 =	Single retransmit output 0-5, 1-5, 0-10VDC, 0-20mA, 4-20mA
2 =	Dual retransmit outputs 0-5, 1-5, 0-10VDC, 0-20mA, 4-20mA

⑩ Language and RTD Option	
1 =	English with 100Ω RTD
2 =	German with 100Ω RTD
3 =	French with 100Ω RTD
4 =	Spanish with 100Ω RTD
5 =	English with 500 and 1KΩ RTD
6 =	German with 500 and 1KΩ RTD
7 =	French with 500 and 1KΩ RTD
8 =	Spanish with 500 and 1KΩ RTD

⑪ ⑫ Display and Custom Options	
RG =	Red/Green display
XX =	Custom options: software, setting parameters, overlay

### Dimensional Drawings

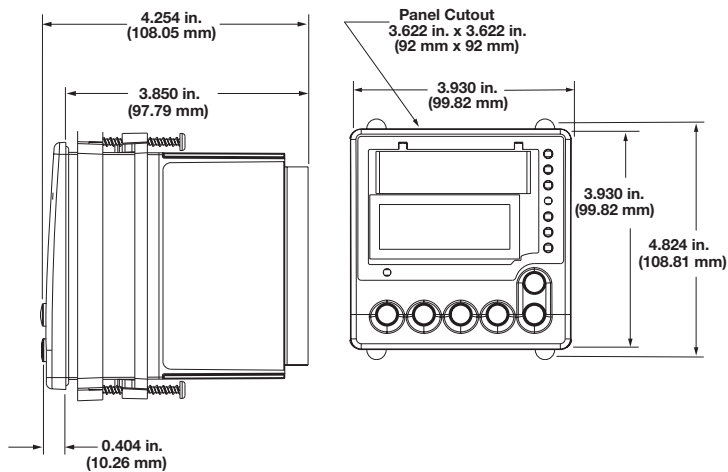

#### Dimension Specifications

- Width x height x depth  
3.93 in. x 3.93 in. x 3.85 in. panel mount  
(99 mm x 99 mm x 97 mm)

### Compatible Accessories

#### Operator Interface Terminals (OIT)



Silver Series EM touchscreen operator interface terminals provide a customizable user interface, email event notifications and log and graph data for Watlow controllers and other devices. A Silver Series EM operator interface terminal paired with Watlow controllers is the perfect solution for industrial processes or machine control applications. See page 365.

# Temperature and Process

## EZ-ZONE PM

The EZ-ZONE PM panel mount controller offers control options that reduce system complexity and thermal loop ownership cost. It can be ordered as a PID controller, an over/under limit controller or its functions can be combined into an integrated controller. An option to integrate a high amperage power controller output with a high-performance PID controller and an over/under limit controller in one space-saving, panel mount package is also available. Many communications options are offered to support connectivity needs.

Because the EZ-ZONE PM controller is highly scalable, pay only for what is needed. This controller is available in 1/32, 1/16, 1/8 and 1/4 DIN panel mount packages. The EZ-ZONE PM controller is easy to use and is ideal for PID, over/under limit or integrated controller needs.

### Features and Benefits

#### Integrated PID and limit controller

- Reduces wiring time and termination complexity compared with connecting discrete products
- Decreases required panel space
- Lowers installation costs
- Increases user and equipment safety for over/under temperature conditions

#### High amperage power control output

- Drives 15 ampere resistive loads directly
- Reduces component count
- Decreases cost of ownership

#### Current monitoring

- Detects heater current flow and provides alarm indication of a failed output device or heater load

#### Serial communication capabilities

- Provides a wide range of protocol choices including Modbus® RTU, EtherNet/IP™, Modbus® TCP, PROFIBUS DP and DeviceNet™
- Supports network connectivity to a PC or PLC

#### Dual-channel controller

- Provides two PID controllers in one space-saving package



#### Enhanced control options

- Easily handles complex process problems such as cascade, ratio, differential, square-root, motorized valve control without slidewire feedback, wet-bulb/dry-bulb, compressor control and peltier loads

#### Advanced PID control algorithm

- Offers TRU-TUNE®+ adaptive control to provide tighter control for demanding applications
- Provides auto-tune for fast, efficient startup

#### Configuration communications with software

- Includes Watlow standard bus communications and EZ-ZONE configurator software
- Saves time and improves reliability of controller setup

#### Ten-point linearization curve

- Improves sensor accuracy

For detailed product and ordering information, see the full EZ-ZONE PM product section located on pages **249 through 257.**

# Temperature and Process

## EZ-ZONE PM Express

The EZ-ZONE PM Express panel mount controller is an industry-leading PID controller that allows optimal performance utilizing simple control and menu functionality without complex features. It is ideal for basic applications and usage levels.

The EZ-ZONE PM Express is the next generation controller to follow the legacy of Watlow's SERIES 93, SERIES 935 AND SERIES SD controllers that offer easy-to-use features to perform many basic applications. The EZ-ZONE PM Express includes one universal input and an option for up to two outputs and is available in 1/32, 1/16, 1/8 and 1/4 DIN panel mount packages. It can be ordered as a PID process controller or as a dedicated over and under-temperature limit controller.

The EZ-ZONE PM Express is a valuable addition to the EZ-ZONE PM controller family which also includes the EZ-ZONE PM integrated controller and the EZ-ZONE PM standard version.

### Features and Benefits

#### Simplified menu

- Fits basic applications with a user-friendly interface supported by two menus and a streamlined list of parameters
- Eliminates complexity often experienced with more advanced controllers and unnecessary features
- Reduces training costs and user programming errors

#### PID auto-tune

- Provides auto-tune for fast, efficient startup

#### Standard bus communications

- Allows easy product configuration via PC communications protocol and free software
- Saves time, simplifies programming process and improves reliability of controller setup

#### Factory Mutual (FM) approved over and under limit with auxiliary outputs

- Increases user and equipment safety for over and under-temperature conditions

#### Agency approvals: UL® listed, CSA, CE, RoHS, W.E.E.E., FM, SEMI F47-0200, Class 1, Div. 2 rating on selected models

- Assures prompt product acceptance
- Reduces end product documentation costs



#### Front panel removable

- Saves time and labor for replacements and troubleshooting

#### P3T armor sealing system

- Complies with NEMA 4X, IP65 specifications
- Allows controller to be cleaned and washed
- Certified UL® 50 independent to NEMA 4X specification

#### Touch-safe package

- Increases installer and operator safety
- Complies with IP2X requirements

#### Consistent Termination Labeling (CTL) connection system

- Simplifies switching between products
- Speeds up user's system documentation

#### Three-year warranty

- Demonstrates Watlow's reliability and product support

#### High-amperage power control output

- Drives 15 ampere resistive loads direct
- Reduces component count
- Saves panel space and simplifies wiring
- Reduces cost of ownership

**For detailed product and ordering information, see the full EZ-ZONE PM Express product section located on pages 258 through 261.**

# Temperature and Process

## SERIES CV

Watlow's family of microprocessor-based temperature controllers offers an economical solution for applications that require simple, on/off control. Controllers are available in a broad range of packaging options, allowing selection of the best version for a specific application. They are available with an operator interface and can be ordered in a 1/8 DIN square panel mount or DIN-rail mount configuration.

The SERIES CV temperature controller incorporates a microprocessor design that delivers the repeatability, accuracy and performance advantages you can count on from Watlow's basic temperature controllers.

The SERIES CV controller includes an operator interface for viewing and set point selection. A red, four-character, seven segment LED displays the set point to show process options. The set point selection is made with a continuous turn, rotary encoder. Operating range temperature values are user definable as specified in the product configuration part number.

SERIES CV controllers are UL® and C-UL® listed and carry CSA and CE approvals. Watlow's temperature controllers include industry-leading service and support and are protected by a three-year warranty.



### Features and Benefits

#### Adjustable set points

- Offers control flexibility

#### Four character LED display

- Improves set point selection accuracy

#### Multiple mounting options

- Minimizes installation time

#### Heat or cool operation

- Provides application flexibility

#### Fahrenheit or Celsius operation with indication

- Offers application flexibility

#### Agency approvals

- Meets certification requirements/compliance

#### Microprocessor based technology

- Ensures accurate repeatable control

# Temperature and Process

## SERIES CV

### Specifications

#### On-Off Controller

- Microprocessor based, on-off control mode
- Nominal switching hysteresis, typically 3°F (1.7°C)
- Input filter time: 1 second

#### Operator Interface

- Four digit, seven segment LED displays, 0.28 in. (7 mm) high
- °F or °C indicator LED
- Load indicator LED
- Continuous turn, velocity sensitive rotary encoder for set point adjustment
- Front panel key push for set point or push for show process options

#### Standard Conditions For Specifications

- Rated line voltage, 50 to 60Hz, 0 to 90%, RH, non-condensing, 15-minute warm-up
- Calibration ambient range: 77°F (25°C) ±3°C

#### Sensor Input

##### Thermocouple

- Grounded or ungrounded
- Type E, J, K or T thermocouple
- >10 MΩ input impedance
- 250 nV input referenced error per 1Ω source resistance

##### RTD

- 2-wire platinum, 100Ω
- DIN-curve (0.00385 curve)
- 125 μA nominal RTD excitation current

#### Input Accuracy Span Range

Type E: -328 to 1470°F (-200 to 800°C)  
Type J: 32 to 1382°F (0 to 750°C)  
Type K: -328 to 2282°F (-200 to 1250°C)  
Type T: -328 to 662°F (-200 to 350°C)  
RTD (DIN) -328 to 1472°F (-200 to 800°C)

#### Thermocouple Input

- Calibration accuracy: ±1% of input accuracy span, ±1° at standard conditions and actual calibration ambient. Exception: Type T, ±2.4% of input accuracy span for -328 to 32°F (-200 to 0°C)
- Temperature stability: ±0.3 degree per degree change in ambient

#### RTD Input

- Calibration accuracy ±1% of input accuracy span ±1° at standard conditions and actual calibration ambient
- Temperature stability: ±0.2 degree per degree change in ambient

#### Allowable Operating Ranges

Type E: -328 to 1470°F (-200 to 800°C)  
Type J: -346 to 1900°F (-210 to 1038°C)  
Type K: -454 to 2500°F (-270 to 1370°C)  
Type T: -454 to 750°F (-270 to 400°C)  
RTD (DIN) -328 to 1472°F (-200 to 800°C)

#### Output Types

##### Switched dc (non-isolated)

- Supply voltage max.: 24VDC into an infinite load
- Supply voltage min.: 5VDC at 10mA
- Min. load impedance: 500Ω

##### Electromechanical Relay, Form C

- Min. load current: 100mA
- 8A @ 240VAC or 30VDC max., resistive
- 250VA pilot duty, 120/240VAC max., inductive
- Use RC suppression for inductive loads
- Electrical life 100,000 cycles at rated current

#### Agency Approvals

- UL® 60730-1 Recognized Temperature Controller and Indicator on potted models
- UL® 50 IP65 - tactile key models
- UL® 197 Reviewed for Use in Cooking Appliances
- UL® 873
- ANSI Z21.23 Gas Appliance Thermostat Approval
- Temperature Control and Indicator CSA 22.2 No. 24

#### Terminals

- 0.25 in. (6.3 mm) quick connect, push on terminal or removable screw style terminal block

#### Power

- 24VAC +10%; -15%; 50/60Hz, ±5%
- 120VAC +10%; -15%; 50/60Hz, ±5%
- 230 to 240VAC +10%; -15%; 50/60Hz, ±5%
- 10VA max. power consumption
- Data retention upon power failure via nonvolatile memory

#### Operating Environment

- 32 to 158°F (0 to 70°C)
- 0 to 90% RH, non-condensing
- Storage temperature: -40 to 185°F (-40 to 85°C)

#### Dimensions

- DIN-rail model can be DIN-rail or chassis mount  
DIN-rail spec DIN 50022, 1.38 in. x 0.30 in. (35 mm x 7.5 mm)

Style	Width	Height	Depth
DIN-rail	3.08 in. (78.1 mm)	4.42 in. (112.3 mm)	3.57 in. (90.7 mm)
Square ½ DIN-panel	2.85 in. (72.4 mm)	2.85 in. (72.4 mm)	Behind panel 2.04 in. (51.7 mm)

# Temperature and Process

## SERIES CV

### Ordering Information

- On-off controller, rotary set point adjustment, four character, seven segment display

#### Part Number

① ②	③	④	⑤	⑥	⑦ ⑧ ⑨ ⑩	⑪ ⑫ ⑬ ⑭	⑮
	Power Supply	Package	Sensor Type and Scale	Control Type	Low Set Point	High Set Point	Overlay/Customs Options
CV							

③ Power Supply	
B =	120VAC, switched dc output
C =	120VAC, 8A relay output
D =	230 to 240VAC, switched dc output
E =	230 to 240VAC, 8A relay output
F =	24VAC, switched dc output
G =	24VAC, 8A relay output

④ Package	
1 =	Panel mount square 1/8 DIN - spade terminals
2 =	DIN-rail mount - spade terminals
5 =	Panel mount square 1/8 DIN - screw terminals
6 =	DIN-rail mount - screw terminals
A =	NEMA 4X panel mount, tactile keys (spade terminals)
B =	DIN-rail mount, tactile keys (spade terminals)
C =	NEMA 4X panel mount, tactile keys (screw terminals)
D =	DIN-rail mount, tactile keys (screw terminals)

⑤ Sensor Type and Scale	
H =	T/C Type J Fahrenheit (-346 to 1900°F)
J =	T/C Type J Celsius (-210 to 1038°C)
K =	T/C Type K Fahrenheit (-454 to 2500°F)
L =	T/C Type K Fahrenheit (-270 to 1370°F)
M =	T/C Type T Fahrenheit (-454 to 750°F)
N =	T/C Type T Fahrenheit (-270 to 400°F)
P =	RTD Fahrenheit (-328 to 1472°F)
R =	RTD Celsius (-200 to 800°C)
S =	T/C Type E Fahrenheit (-328 to 1470°F)
T =	T/C Type E Celsius (-200 to 800°C)

⑥ Control Type	
H =	Heat
C =	Cool

⑦ ⑧ ⑨ ⑩ Low Set Point Operating Range Value	
<b>Note:</b> A (-) is used in the left most digit of the set point operating ranges to indicate a negative temperature value.	

⑪ ⑫ ⑬ ⑭ High Set Point Operating Range Value	
<b>Note:</b> A (-) is used in the left most digit of the set point operating ranges to indicate a negative temperature value.	

⑮ Overlay/Customs Options	
A =	Standard with Watlow logo
B =	Push to show process with Watlow logo
C =	Push to adjust set point with Watlow logo
D =	Show process push to adjust set point with Watlow logo
1 =	Standard without Watlow logo
2 =	Push to show process without Watlow logo
3 =	Push to adjust set point without Watlow logo
4 =	Show process push to adjust set point without Watlow logo

# Temperature and Process

## SERIES CF

Watlow's family of microprocessor-based temperature controllers offers an economical solution for applications that require simple, on-off control. Controllers are available in a broad range of packaging options, allowing selection of the best version for a specific application. They are available with or without an indicating display and can be ordered in a 1/8 DIN square panel mount, DIN-rail mount or open board design configuration.

The SERIES CF temperature controller incorporates a microprocessor design that delivers the repeatability, accuracy and performance advantages you can count on from Watlow's basic temperature controllers. Fixed set points are available and an indicating display is an option. Operating set point temperature values can be specified in the product configuration part number.

SERIES CF controllers are UL® and C-UL® listed and carry CSA and CE approvals. Watlow's temperature controllers include industry-leading service and support and are protected by a three-year warranty.



### Features and Benefits

#### Fixed set points

- Provides tamper-proof operation

#### Multiple mounting options

- Minimizes installation time

#### Heat or cool operation

- Provides application flexibility

#### Fahrenheit or Celsius operation with indication

- Offers application flexibility

#### Agency approvals

- Meets certification requirements/compliance

#### Microprocessor based technology

- Ensures accurate repeatable control

# Temperature and Process

## SERIES CF

### Specifications

#### On-Off Controller

- Microprocessor based, on-off control mode
- Nominal switching hysteresis, typically 3°F (1.7°C)
- Input filter time: 1 second

#### Operator Interface

- 4-digit, 7-segment LED displays, 0.28 in. (7 mm) high non-condensing, 15-minute warm-up
- °F or °C indicator LED

#### Standard Conditions For Specifications

- Rated line voltage, 50 to 60Hz, 0 to 90%, RH, non-condensing, 15-minute warm-up
- Calibration ambient range: 77°F (25°C) ±3°C

#### Sensor Input

##### Thermocouple

- Grounded or ungrounded
- Type E, J, K or T thermocouple
- >10 MΩ input impedance
- 250 nV input referenced error per 1Ω source resistance

##### RTD

- 2-wire platinum, 100Ω
- DIN-curve (0.00385 curve)
- 125 μA nominal RTD excitation current

#### Input Accuracy Span Range

Type E: -328 to 1470°F (-200 to 800°C)  
Type J: 32 to 1382°F (0 to 750°C)  
Type K: -328 to 2282°F (-200 to 1250°C)  
Type T: -328 to 662°F (-200 to 350°C)  
RTD (DIN) -328 to 1472°F (-200 to 800°C)

#### Thermocouple Input

- Calibration accuracy: ±1% of input accuracy span, ±1° at standard conditions and actual calibration ambient. Exception: Type T, ±2.4% of input accuracy span for -328 to 32°F (-200 to 0°C)
- Temperature stability: ±0.3 degree per degree change in ambient

#### RTD Input

- Calibration accuracy ±1% of input accuracy span ±1° at standard conditions and actual calibration ambient
- Temperature stability: ±0.2 degree per degree change in ambient

#### Allowable Operating Ranges

Type E: -328 to 1470°F (-200 to 800°C)  
Type J: -346 to 1900°F (-210 to 1038°C)  
Type K: -454 to 2500°F (-270 to 1370°C)  
Type T: -454 to 750°F (-270 to 400°C)  
RTD (DIN) -328 to 1472°F (-200 to 800°C)

### Output Types

#### Switched dc (non-isolated)

- Supply voltage max.: 24VDC into an infinite load
- Supply voltage min.: 5VDC at 10mA
- Min. load impedance: 500Ω

#### Electromechanical Relay, Form C

- Min. load current: 100mA
- 8A @ 240VAC or 30VDC max., resistive
- 250VA pilot duty, 120/240VAC max., inductive
- Use RC suppression for inductive loads
- Electrical life 100,000 cycles at rated current

#### Agency Approvals

- UL® 60730-1 Recognized Temperature Controller and Indicator on potted models
- UL® 197 Reviewed for Use in Cooking Appliances
- UL® 873
- ANSI Z21.23 Gas Appliance Thermostat Approval
- Temperature Control and Indicator CSA 22.2 No. 24

#### Terminals

- 0.25 in. (6.3 mm) quick connect, push on terminal or removable screw style terminal block

#### Power

- 24VAC +10%; -15%; 50/60Hz, ±5%
- 120VAC +10%; -15%; 50/60Hz, ±5%
- 230 to 240VAC +10%; -15%; 50/60Hz, ±5%
- 10VA max. power consumption
- Data retention upon power failure via nonvolatile memory

#### Operating Environment

- 32 to 158°F (0 to 70°C)
- 0 to 90% RH, non-condensing
- Storage temperature: -40 to 185°F (-40 to 85°C)

#### Dimensions

- DIN-rail model can be DIN-rail or chassis mount  
DIN-rail spec DIN 50022, 1.38 in. x 0.30 in. (35 mm x 7.5 mm)

Style	Width	Height	Depth
Open Board	2.43 in. (61.7 mm)	2.43 in. (61.7 mm)	1.78 in. (45.1 mm)
Potted	2.76 in. (70.1 mm)	4.05 in. (102.9 mm)	1.84 in. (46.6 mm)
DIN-rail	3.08 in. (78.1 mm)	4.42 in. (112.3 mm)	3.57 in. (90.7 mm)
Square ¼ DIN-panel	2.85 in. (72.4 mm)	2.85 in. (72.4 mm)	Behind panel 2.04 in. (51.7 mm)



# Temperature and Process

## SERIES CF

### Ordering Information

- On-off controller, fixed set point, no user interface

#### Part Number

<b>① ②</b>	<b>③</b>	<b>④</b>	<b>⑤</b>	<b>⑥</b>	<b>⑦ ⑧ ⑨ ⑩</b>	<b>⑪ ⑫ ⑬ ⑭</b>	<b>⑮</b>
	Power Supply	Package	Sensor Type and Scale	Control Type	Fixed Set Point Temp. Value		Overlay/Customs Options
CF						AAAA	

③ Power Supply	
B =	120VAC, switched dc output
C =	120VAC, 8A relay output
D =	230 to 240VAC, switched dc output
E =	230 to 240VAC, 8A relay output
F =	24VAC, switched dc output
G =	24VAC, 8A relay output

④ Package	
1 =	Panel mount square 1/8 DIN - spade terminals
2 =	DIN-rail mount - spade terminals
3 =	Open board, non potted - spade terminals
4 =	Potted case - spade terminals
5 =	Panel mount square 1/8 DIN - screw terminals
6 =	DIN-rail mount - screw terminals
7 =	Open board, non potted - screw terminals

⑤ Sensor Type and Scale	
H =	T/C Type J Fahrenheit (-346 to 1900°F)
J =	T/C Type J Celsius (-210 to 1038°C)
K =	T/C Type K Fahrenheit (-454 to 2500°F)
L =	T/C Type K Celsius (-270 to 1370°F)
M =	T/C Type T Fahrenheit (-454 to 750°F)
N =	T/C Type T Celsius (-270 to 400°F)
P =	RTD Fahrenheit (-328 to 1472°F)
R =	RTD Celsius (-200 to 800°C)
S =	T/C Type E Fahrenheit (-328 to 1470°F)
T =	T/C Type E Celsius (-200 to 800°C)

⑥ Control Type	
H =	Heat
C =	Cool

⑦ ⑧ ⑨ ⑩ Fixed Set Point Temperature Value	
<b>Note:</b> A (-) is used in the left most digit of the set point operating ranges to indicate a negative temperature value.	

⑮ Overlay/Customs Options	
A =	Standard with Watlow logo
1 =	Standard without Watlow logo

# Temperature and Process

## SERIES EHG® SL10

The SERIES EHG® SL10 integrated, multi-function controller is a key component to a powerful system that includes a heater, an adjustable set point temperature controller, a high/low temperature alert, a power switching device and a high temperature safety limit. Its agency recognized controller/safety limit meets UL® 1998 and CE 60730 requirements.

An optional display/communications module can be easily added in the field to provide a digital display indication, an adjustment of set point, RS485 Modbus® communications and other Human Machine Interface (HMI) features. As a scalable system, only what is needed can be purchased.

The EHG SL10 controllers' easy to install, compact design, inherent reliability and integrated limit functions offer unmatched value. It is designed for easy integration with Watlow heaters to simplify engineering, reduce component count for new equipment and decrease ownership cost. For original equipment manufacturers, (OEMs), the EHG SL10 controller's CE, Semi-S2 compliance and UL® recognition reduces time and costs associated with global agency testing and validation. U.S. Patent Number 8,044,329.

### Features and Benefits

#### Extended temperature range -0.4 to 999°F (-18 to 537°C)

- Ideal for demanding environments

#### Process controller and safety limit in one package

- Meets UL® 1998 and CE 60730 requirements
- Eliminates the need for a thermal fuse on a heater
- Eliminates replacement of heater when fuse fails

#### Optional display/communications module

- Allows easy upgrade on to base device
- Offers low cost field upgrade
- Provides easy, snap-on installation

#### Accurate and flexible temperature process controller

- Replaces problematic bi-metal thermostats with accurate electronic temperature process controller
- Allows easy change of process parameters

#### Extended set point/process range

- Supports broader applications

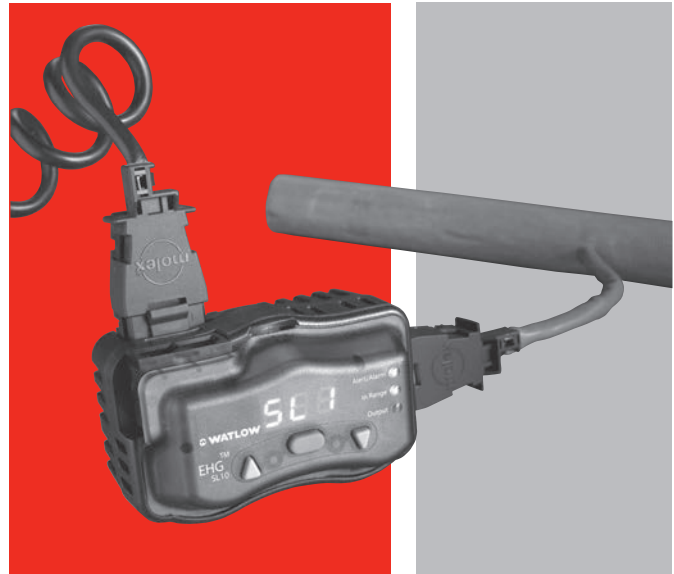

#### Ambient operating temperature range 32 to 158°F (0 to 70°C)

- Increases reliability when mounting in harsh temperature environments or in close proximity to heaters

#### Integrated high/low temperature alert signal relay

- Provides dry contact output to activate external alarm or process function
- Signals control status with three integrated LEDs
- Allows a signal of up to two amperes 30VAC/MDC, Form A to alert if process temperature is out of range limits

#### Health check diagnostics

- Monitors maximum heater process temperature, maximum ambient temperature and thermocouple operation
- Provides health check signal to inform operator that the process is working correctly

#### Universal power supply

- Allows an input of 85 to 264VAC, 50/60Hz
- Provides safe control of up to 2400 watts with 10 amperes switching in both controller and safety limit

#### Can be switched from on-off and PID algorithm

- Increases product life (on-off control is default)
- Offers selectable PID control algorithm for tighter temperature uniformity

**For detailed product and ordering information, see the full EHG SL10 product section located on pages 262 through 265.**

# Temperature and Process

## SERIES EHG

Many applications requiring a fixed temperature set point rely on a mechanical thermostat for thermal control. Thermostats have proven, however, to be inadequate for many applications due to long-term reliability issues, such as 100,000 cycle rating and poor temperature control.

The SERIES EHG thermal solution includes a compact temperature control, thermocouple sensor and power switching device integrated into the heater's power cord. The SERIES EHG reduces system costs and lasts substantially longer than a conventional thermostat solution.

The evolution of miniature microprocessor technology and Watlow switching technology fostered development of a small, versatile temperature control and thermocouple sensor that is integrated with Watlow silicone rubber heater products. This device senses the temperature via input from a thermocouple strategically placed on the heater mat. The microprocessor is programmed prior to shipment with an application specific set point. This results in quick delivery of a custom, integrated system.

The small thermocouple mass provides superior response to changes in process temperature enabling higher watt density silicone rubber heater designs. These features offer an integrated custom set point temperature controller with superior life span, faster heat-up rates and improved accuracy. The SERIES EHG System has been tested to over four million cycles at rated amperage. Depending on the application, Watlow's power switching design can last up to 40 times longer than a conventional thermostat.

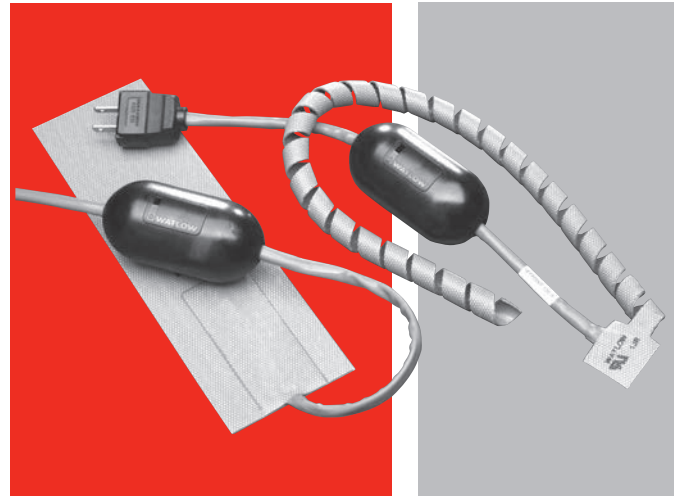

### Features and Benefits

#### Long operational life

- Improves system reliability

#### Tight temperature control

- Ensures process accuracy

#### Small sensor footprint

- Fits with almost any heater
- Responds quickly to temperature changes
- Controls high watt densities in low mass applications

#### Reduced system cost

- A single EHG control can be configured with multiple heaters

#### Pre-wired, in line control

- Simplifies installation
- Two wire power connection

#### Durable housing with built-in strain relief

- Protects electronics
- Low risk of mechanical damage

#### Manufactured with proven Watlow components

- Assures reliable system performance

**For detailed product and ordering information, see the full EHG product section located on pages 266 through 267.**



# Limits and Scanners

Product	Maximum Limit Loops	Maximum Monitor Channels	Mounting	Agency Approvals	Communication Protocols	Page
<b>F4T with INTUITION®</b>	6	24	DIN-rail, Flush mount	UL® listed, CSA, CE, RoHS, W.E.E.E., FM	Standard bus, Modbus® TCP (Ethernet), Modbus® RTU, SCPI, USB Host (2), USB device	<b>299</b>
<b>EZ-ZONE® RM High-Density Limit</b>	192	192	DIN-rail	UL®, CSA, CE, RoHS, W.E.E.E., FM, SEMI F47-0200	Standard bus, EtherNet/IP™, DeviceNet™, PROFIBUS DP, Modbus® TCP, Modbus® RTU	<b>300</b>
<b>EZ-ZONE RM High-Density Scanner</b>	0	256	DIN-rail	UL®, CSA, CE, RoHS, W.E.E.E., SEMI F47-0200	Standard bus, EtherNet/IP™, DeviceNet™, PROFIBUS DP, Modbus® TCP, Modbus® RTU	<b>302</b>
<b>EZ-ZONE PM Limit</b>	1	1	1/32, 1/16, 1/8, 1/4 DIN front panel	UL®, CSA, CE, RoHS, W.E.E.E., FM, SEMI F47-0200	Standard bus, EtherNet/IP™, DeviceNet™, PROFIBUS DP, Modbus® TCP, Modbus® RTU	<b>304</b>
<b>EZ-ZONE PM Express Limit</b>	1	1	1/32, 1/16, 1/8, 1/4 DIN front panel	UL®, CSA, CE, RoHS, W.E.E.E., FM, SEMI F47-0200	Standard bus	<b>310</b>
<b>SERIES LV</b>	1	1	DIN-rail, Front panel, chassis	UL®, CSA, CE, ANSI Z21.23, RoHS, W.E.E.E., FM	N/A	<b>314</b>
<b>SERIES LF</b>	1	1	DIN-rail, Front panel, chassis	UL®, CSA, CE, ANSI Z21.23, RoHS, W.E.E.E., FM	N/A	<b>317</b>
<b>SERIES LS</b>	1	1	Potted case with mounting screws	UL®/EN 60730-1, 2, 9, UL® 1998, CE, W.E.E.E., RoHS	N/A	<b>320</b>
<b>TLM SERIES</b>	8	8	DIN-rail, chassis	UL®, C-UL®, CE, FM	N/A	<b>322</b>

**Note:** The specifications in the table above are best available values in each category. Not all combinations of these values are available in a single model number.



# Limits and Scanners

## F4T with INTUITION®

The F4T with INTUITION® temperature process controller offers a wide range of field removable I/O modules for maximum design flexibility. Configurations can be custom tailored to meet the scaling needs of a tremendous range of equipment and applications while providing exactly the hardware types required for compatibility. The F4T controller also features a 4.3 inch, color, graphical touch panel. Combining power, flexibility and functionality, this new controller offers unmatched versatility, and its best-in-class ease of use could very well make user manuals a thing of the past.

### Features and Benefits

#### 4.3-inch, color touch panel with high-resolution, graphical user-interface

- Shortens learning curve and reduces operator errors
- Allows channels, profiles, alarms, inputs and outputs to be personalized with user defined names

#### Temperature PID, data logger, trend chart, over/under-temperature limit, power switching, math, logic, timers and counters combined into an integrated system

- Lowers ownership costs
- Eliminates the need for separate discrete components
- Reduces complexity
- Simplifies design, ordering and installation
- Saves money

#### Robust algorithms for temperature, cascade, altitude, humidity and compressor

- Improves process control
- Offers one to four channels of control
- Provides multiple PID sets
- Enables TRU-TUNE®+ adaptive control algorithm
- Offers 40 ramp and soak profiles with real-time clock and battery backup

#### COMPOSER® graphical configuration PC software

- Speeds up and simplifies commissioning
- Archives and documents controller setup
- Connects with controller easily via Ethernet

#### Many communications options available including Ethernet Modbus® TCP and SCPI and EIA-232/485 Modbus® RTU

- Offers two USB host ports and one device port
- Simplifies file transfers
- Connects easily



#### Modular design

- Adapts quickly to evolving requirements
- Offers numerous types of field pluggable modules for maximum flexibility and easiest compatibility
- Features scalable and modular firmware functions
- Delivers scalable input/output quantities from 1 to 36

#### Agency certifications include UL®, FM, CE, RoHS, W.E.E.E., NEMA 4X/IP65

- Ensures high quality and reliability
- Verifies performance in installations worldwide

#### SERIES F4S/F4D/F4P backward compatible

- Provides easy retrofit with minimum pain and disruption
- Ensures proper fit in existing SERIES F4 panel cutout

#### Off-the-shelf solution

- Provides cost-effective “make versus buy”
- Offers preconfigured touch-panel screens
- Assures quicker time to market

**For detailed product and ordering information, see the full F4T product section located on pages 211 through 221.**

# Limits and Scanners

## EZ-ZONE® RM High-Density Limit

The EZ-ZONE® RM high-density limit module used in conjunction with the EZ-ZONE RM temperature control module and high-density control module offer agency approved over and under temperature limit function to ensure system safety. The EZ-ZONE RM high-density limit controls 4, 8, or 12 limit loops per module or up to 128 limit loops per system.

### Features and Benefits

#### 1 to 128 loop limit controller

- Eliminates compatibility issues often encountered with using many different discrete components and brands
- Saves engineering time and labor costs while shortening project schedules
- Allows a common limit controller platform across many design applications

#### Communications

- Allows standard bus communications
- Ability to utilize EIA-485, Modbus® RTU options

#### SPLIT-RAIL control

- Minimizes the length and cost of wire runs and improves system reliability by locating inputs closer to sensors and outputs closer to loads

#### SENSOR GUARD

- Prevents unplanned process shutdowns and product loss by switching to a backup sensor if the primary sensor fails

#### AUTO CLONE

- Saves time and reduces complexity by automatically configuring a new module with the same parameter settings as the replaced module



### High-Density Limit Module Specifications (RML)

(Select an RML module for 4 to 12 safety limits.)

#### Line Voltage/Power

- Power consumption: 7 W, 14VA
- Any external power supply used should comply with a Class 2 or SELV rating

#### Serial Communications

- Isolated communications
- All modules ship with standard bus protocol for configuration and communication with all EZ-ZONE controllers

#### Additional Communication Option

- EIA-485, Modbus® RTU

#### Calibration Accuracy

- Calibration accuracy and sensor conformity:  $\pm 0.1\%$  of span,  $\pm 1^\circ\text{C}$  @ the calibrated ambient temperature and rated line voltage
  - Types R, S, B; 0.2%
  - Type T below  $-50^\circ\text{C}$ ; 0.2%
- Calibration ambient temperature @  $77^\circ\text{F} \pm 5^\circ\text{F}$  ( $25^\circ\text{C} \pm 3^\circ\text{C}$ )
- Accuracy span:  $1000^\circ\text{F}$  ( $540^\circ\text{C}$ ) min.
- Temperature stability:  $\pm 0.1^\circ\text{F}/^\circ\text{F}$  ( $\pm 0.1^\circ\text{C}/^\circ\text{C}$ ) rise in ambient max.

#### Universal Input

- Thermocouple, grounded or ungrounded sensors
- $>20\text{M}\Omega$  input impedance
- Max. of  $2\text{k}\Omega$  source resistance
- RTD 2-wire, platinum,  $100\Omega$  and  $1000\Omega$  @  $32^\circ\text{F}$  ( $0^\circ\text{C}$ ) calibration to DIN curve ( $0.00385\Omega/\Omega/^\circ\text{C}$ )
- Process,  $0\text{-}20\text{mA}$  @  $100\Omega$ , or  $0\text{-}10\text{VDC}$  @  $20\text{k}\Omega$  input impedance; scalable,  $0\text{-}50\text{mV}$



# Limits and Scanners

## EZ-ZONE RM High-Density Limit

### High-Density Limit Module Specifications (RML) (Continued)

#### Thermistor Input

- 0 to 40kΩ, 0 to 20kΩ, 0 to 10kΩ, 0 to 5kΩ
- 2.252kΩ and 10kΩ base at 77°F (25°C)
- Linearization curves built-in

#### Digital Input

- Update rate 10Hz
- DC voltage
- Max. input 36V at 3mA
- Min. high state 3V at 0.25mA
- Max. low state 2V

#### Dry Contact Input

- Update rate 10Hz
- Min. open resistance 10kΩ
- Max. closed resistance 50Ω
- Max. short circuit 13mA

#### Output Hardware

- 6 digital inputs/outputs:
  - Switched dc, max. 20VDC @ 40mA, 12VDC @ 80mA
  - Open collector, max. 32VDC @ 1.5A, max. 8A per 6 outputs combined
- Electromechanical relay, Form A, 5A, 24 to 240VAC or 30VDC max., resistive load, 100,000 cycles at rated load, requires a min. load of 20mA at 24V, 125VA pilot duty

### High-Density Limit Module Ordering Information

Requires 24 to 28VAC/VDC power supply, includes communication port for configuration with EZ-ZONE configurator and PC

#### Part Number

① ② EZ-ZONE Rail Mount	③ Limit Module	④ Connector Style	-	⑤ Slot A	⑥ Slot B	⑦ Slot D	-	⑧ Slot E	-	⑨ Future Option	⑩ Enhanced Options	⑪ ⑫ Additional Options
RM	L		-				-		-	A		

④ Connector Style/Custom Product	
A =	Right angle screw connector (standard)
F =	Front screw connector
S =	Custom

⑤ Slot A	
5 =	4 universal inputs (T/C, RTD 2-wire, 0-10VDC, 0-20mA) with limit control loops
6 =	4 thermistor inputs with limit control loops

⑥ Slot B	
A =	None
5 =	4 universal inputs (T/C, RTD 2-wire, 0-10VDC, 0-20mA) with limit control loops
6 =	4 thermistor inputs with limit control loops

⑦ Slot D	
A =	None
5 =	4 universal inputs (T/C, RTD 2-wire, 0-10VDC, 0-20mA) with limit control loops
6 =	4 thermistor inputs with limit control loops
J =	4 mechanical relay 5A, Form A
C =	6 digital I/O*

\* Reset limits via digital input, EZ key on RUI or communications commands

⑧ Slot E	
J =	4 mechanical relay 5A, Form A
B =	1 digital input and 2 mechanical relays, 5A (1 Form A and 1 Form C)

⑩ Enhanced Options	
A =	Right angle screw connector (standard)
1 =	Custom

⑪ ⑫ Additional Options	
Firmware, Overlays, Parameter Settings	
AA =	Standard
AB =	Replacement connectors hardware only, for the entered part number
XX =	Custom

# Limits and Scanners

## EZ-ZONE RM High-Density Scanner

The EZ-ZONE RM high-density scanner module can be used in conjunction with any EZ-ZONE RM family module as a monitor or to provide additional logic function to a system. The scanner module can also be used as a stand alone product for multiple inputs of monitoring applications. The EZ-ZONE RM high-density scanner module provides 4, 8, 12 or 16 loops of monitoring per module or up to 256 monitoring loops per system.

### Features and Benefits

#### 4 to 256 monitoring loops

- Monitor only—thermocouple, RTD, process or thermistor inputs
- Data log via the EZ-ZONE RM control module
- Accept up to 12 digital inputs
- Activate up to 12 digital outputs

#### Communications

- Allows standard bus communications
- Ability to utilize EIA-485, Modbus® RTU options

#### Add on Logic

- Adds up to 116 points of logic to your system

### High-Density Scanner Module Specifications (RMS)

(Select an RMS module for 4 to 16 auxiliary analog inputs.)

#### Line Voltage/Power

- Power consumption: 7 W, 14VA
- Any external power supply used should comply with a Class 2 or SELV rating

#### Serial Communications

- Isolated communications
- All modules ship with standard bus protocol for configuration and communication with all EZ-ZONE controllers

#### Additional Communication Option

- EIA-485, Modbus® RTU

#### Calibration Accuracy

- Calibration accuracy and sensor conformity:  $\pm 0.1\%$  of span,  $\pm 1^\circ\text{C}$  @ the calibrated ambient temperature and rated line voltage
  - Types R, S, B; 0.2%
  - Type T below  $-50^\circ\text{C}$ ; 0.2
- Calibration ambient temperature @  $77^\circ\text{F} \pm 5^\circ\text{F}$  ( $25^\circ\text{C} \pm 3^\circ\text{C}$ )
- Accuracy span:  $1000^\circ\text{F}$  ( $540^\circ\text{C}$ ) min.
- Temperature stability:  $\pm 0.1^\circ\text{F}/^\circ\text{F}$  ( $\pm 0.1^\circ\text{C}/^\circ\text{C}$ ) rise in ambient max.



#### Universal Input

- Thermocouple, grounded or ungrounded sensors
- $>20\text{M}\Omega$  input impedance
- Max. of  $2\text{k}\Omega$  source resistance
- RTD 2-wire, platinum,  $100\Omega$  and  $1000\Omega$  @  $32^\circ\text{F}$  ( $0^\circ\text{C}$ ) calibration to DIN curve ( $0.00385\Omega/\Omega/^\circ\text{C}$ )
- Process,  $0\text{-}20\text{mA}$  @  $100\Omega$ , or  $0\text{-}10\text{VDC}$  @  $20\text{k}\Omega$  input impedance; scalable,  $0\text{-}50\text{mV}$

#### Thermistor Input

- $0$  to  $40\text{k}\Omega$ ,  $0$  to  $20\text{k}\Omega$ ,  $0$  to  $10\text{k}\Omega$ ,  $0$  to  $5\text{k}\Omega$
- $2.252\text{k}\Omega$  and  $10\text{k}\Omega$  base at  $77^\circ\text{F}$  ( $25^\circ\text{C}$ )
- Linearization curves built-in

#### Digital Input

- Update rate  $10\text{Hz}$
- DC voltage
- Max. input  $36\text{V}$  at  $3\text{mA}$
- Min. high state  $3\text{V}$  at  $0.25\text{mA}$
- Max. low state  $2\text{V}$

#### Dry Contact Input

- Update rate  $10\text{Hz}$
- Min. open resistance  $10\text{k}\Omega$
- Max. closed resistance  $50\Omega$
- Max. short circuit  $13\text{mA}$

#### Output Hardware

- 6 digital inputs/outputs:
  - Switched dc, max.  $20\text{VDC}$  @  $40\text{mA}$ ,  $12\text{VDC}$  @  $80\text{mA}$
  - Open collector, max.  $32\text{VDC}$  @  $1.5\text{A}$ , max.  $8\text{A}$  per 6 outputs combined
- Electromechanical relay, Form A,  $5\text{A}$ ,  $24$  to  $240\text{VAC}$  or  $30\text{VDC}$  max., resistive load,  $100,000$  cycles at rated load, requires a min. load of  $20\text{mA}$  at  $24\text{V}$ ,  $125\text{VA}$  pilot duty

# Limits and Scanners

## EZ-ZONE RM High-Density Scanner

### High-Density Scanner Module Ordering Information

Requires 24 to 28VAC/VDC power supply, includes communication port for configuration with EZ-ZONE configurator and PC

#### Part Number

① ②	③	④	⑤	⑥	⑦	⑧	⑨	⑩	⑪ ⑫
EZ-ZONE Rail Mount	Scanner Module	Connector Style	Slot A	Slot B	Slot D	Slot E	Future Option	Enhanced Options	Additional Options
RM	S		-				-	A	

④ Connector Style/Custom Product	
A =	Right angle screw connector (standard)
F =	Front screw connector
S =	Custom

⑤ Slot A	
R =	4 universal inputs (T/C, RTD 2-wire, 0-10VDC, 0-20mA) without control loops
P =	4 thermistor inputs without control loops

⑥ Slot B	
A =	None
R =	4 universal inputs (T/C, RTD 2-wire, 0-10VDC, 0-20mA) without control loops
P =	4 thermistor inputs without control loops

⑦ Slot D	
A =	None
R =	4 universal inputs (T/C, RTD 2-wire, 0-10VDC, 0-20mA) without control loops
P =	4 thermistor inputs without control loops
J =	4 mechanical relay 5A, Form A
C =	6 digital I/O

⑧ Slot E	
A =	None
R =	4 universal inputs (T/C, RTD 2-wire, 0-10VDC, 0-20mA) without control loops
P =	4 thermistor inputs without control loops
J =	4 mechanical relay 5A, Form A
C =	6 digital I/O
B =	1 digital input and 2 mechanical relays, 4A

⑩ Enhanced Options	
A =	Standard bus
1 =	Standard bus and Modbus® RTU 485 (user-selectable)

⑪ ⑫ Additional Options	
<b>Firmware, Overlays, Parameter Settings</b>	
AA =	Standard
AB =	Replacement connectors hardware only, for the entered part number
XX =	Custom

# Limits and Scanners

## EZ-ZONE PM Limit

The EZ-ZONE PM panel mount limit controller from Watlow offers control options to reduce system complexity and the cost of thermal loop ownership. The EZ-ZONE PM limit controller provides high amperage power controller output and over/under limit control in one space saving, panel mount package.

Because the EZ-ZONE PM limit controller is scalable the customer only pays for what is needed. This controller is available in 1/32, 1/16, 1/8 and 1/4 DIN panel mount packages.

### Features and Benefits - Standard

#### Configuration communications with software

- Saves time and improves reliability of controller setup

#### Factory Mutual (FM) approved over/under limit with auxiliary outputs

- Increases user and equipment safety for over/under temperature conditions

#### Memory for saving and restoring parameter settings

- Reduces service calls and down time

#### Agency approvals: UL® listed, CSA, CE, RoHS, W.E.E.E., FM, SEMI F47-0200

- Ensures prompt product acceptance
- Reduces end product documentation costs

#### Touch-safe package

- Increases installer/operator safety
- Complies with IP2X requirements

#### Consistent termination labeling connection system

- Simplifies switching between products
- Speeds up user's system documentation

#### EZ-KEY

- Enables simple, one-touch operation of user defined, repetitive activities

#### Programmable menu system

- Reduces setup time and increases operator efficiency

#### Three-year warranty

- Ensures product support and protection



### Features and Benefits - Optional

#### High amperage power control output

- Drives 5 amperes resistive loads direct
- Reduces component count
- Decreases ownership cost

#### Serial communication capabilities

- Provides a wide range of protocol choices including Modbus® RTU, EtherNet/IP™, Modbus® TCP, PROFIBUS DP and DeviceNet™
- Supports network connectivity to a PC or PLC

# Limits and Scanners

## EZ-ZONE PM Limit

### Specifications

#### Controller

- Agency approved safety-shutdown over/under limit
- User-programmable alarms
- Control sampling rates: input = 10Hz, outputs = 10Hz

#### Isolated Serial Communications

- EIA-232/485, Modbus<sup>®</sup> RTU
- EtherNet/IP<sup>™</sup>/Modbus<sup>®</sup> TCP
- DeviceNet<sup>™</sup>
- PROFIBUS DP

#### Wiring Termination—Touch-Safe Terminals

- Input, power and controller output terminals are touch safe, removable, 12 to 22 AWG

#### Universal Input

- Thermocouple, grounded or ungrounded sensors greater than 20M $\Omega$  input impedance, 3 $\mu$ A open sensor detection, 2k $\Omega$  source resistance max.
- RTD 2- or 3-wire, platinum, 100 $\Omega$  and 1000 $\Omega$  @ 32°F (0°C) calibration to DIN curve (0.00385 $\Omega$ / $\Omega$ /°C)
- Process, 0-20mA @ 100 $\Omega$ , or 0-10VDC @ 20k $\Omega$ , 0-50mV at 20M $\Omega$ , 0-1000 $\Omega$  potentiometer; scalable; inverse scaling

#### Functional Operating Range

Type J: -346 to 2192°F (-210 to 1200°C)

Type K: -454 to 2500°F (-270 to 1371°C)

Type T: -454 to 750°F (-270 to 400°C)

Type E: -454 to 1832°F (-270 to 1000°C)

Type N: -454 to 2372°F (-270 to 1300°C)

Type C: 32 to 4200°F (0 to 2315°C)

Type D: 32 to 4200°F (0 to 2315°C)

Type F: 32 to 2449°F (0 to 1343°C)

Type R: -58 to 3214°F (-50 to 1767°C)

Type S: -58 to 3214°F (-50 to 1767°C)

Type B: 32 to 3300°F (0 to 1816°C)

RTD (DIN): -328 to 1472°F (-200 to 800°C)

Process: -1999 to 9999 units

#### Accuracy

- Calibration accuracy and sensor conformity:  $\pm 0.1\%$  of span,  $\pm 1^\circ\text{C}$  @ the calibrated ambient temperature and rated line voltage
  - Types R, S, B; 0.2%
  - Type T below  $-50^\circ\text{C}$ : 0.2%
- Calibration ambient temperature @ 77°F  $\pm 5^\circ\text{F}$  ( $25^\circ\text{C} \pm 3^\circ\text{C}$ )
- Accuracy span: 1000°F (540°C) min.
- Temperature stability:  $\pm 0.1^\circ\text{F}/^\circ\text{F}$  ( $\pm 0.1^\circ\text{C}/^\circ\text{C}$ ) rise in ambient max.

#### Thermistor Input

- 0 to 40k $\Omega$ , 0 to 20k $\Omega$ , 0 to 10k $\Omega$ , 0 to 5k $\Omega$
- 2.252k $\Omega$  and 10k $\Omega$  base at 77°F (25°C)
- Linearization curves built-in

#### Digital Inputs (DC Voltage)

- Max. input: 36V at 3mA
- Logic: min. high state 3V at 0.25mA, max. low state 2V

#### Digital Inputs (Dry Contact)

- Logic: min. open resistance 10k $\Omega$ , max. closed resistance 50 $\Omega$
- Max. short circuit: 20mA

#### 2 Digital I/O (ordered with power supply option)

- Update rate: 10Hz
- Input type: user-selectable, dc voltage or dry contact
- Output type: switched dc
- Output voltage: 24V
- Output 5: 24mA max. or drive one 3-pole DIN-A-MITE<sup>®</sup>
- Output 6: 10mA max.

#### Output Hardware

- Switched dc: 22 to 32VDC @ 30mA max. per single output and 40mA max. total per paired outputs (1 & 2, 3 & 4)
- Open collector: 30VDC max. @ 100mA max.
- SSR, Form A, 24 to 240VAC, 1A at 50°F (10°C) to 0.5A at 149°F (65°C) resistive load, 264VAC max., opto-isolated, without contact suppression, 120/240VAC @ 20VA pilot duty
- Electromechanical relay, Form A, 24 to 240VAC or 30VDC max., 5A resistive load, 100,000 cycles at rated load, 120/240 @ 125VA or 24VAC @ 25VA pilot duty
- Electromechanical relay, Form C, 24 to 240VAC or 30VDC max., 5A resistive load, 100,000 cycles at rated load, 120/240 @ 125VA or 24VAC @ 25VA pilot duty
- Universal process output: range selectable; 0 to 10VDC  $\pm 15\text{mV}$  into a min. 1,000 $\Omega$  load with 2.5mV nominal resolution; 0 to 20mA  $\pm 30\mu\text{A}$  into max. 800 $\Omega$  load with 5 $\mu\text{A}$  nominal resolution; temperature stability 100ppm/°C

#### Operator Interface

- Dual 4-digit, 7-segment LED displays
- Advance, RESET, up and down keys, plus 1 or 2 programmable EZ-KEY(s) depending on model size
- Typical display update rate: 1Hz

## EZ-ZONE PM Limit

### Line Voltage/Power

- High voltage option: 85 to 264VAC, 47 to 63Hz
- Low voltage option: 20 to 28VAC, +10/-15%; 50/60Hz, ±5% or 12 to 40VDC
- Max. power consumption: 10VA (1/32 and 1/16 DIN), 14VA (1/8 and 1/4 DIN)
- Data retention upon power failure via nonvolatile memory
- Compliant with SEMI F47-0200, Figure R1-1 voltage sag requirements @ 24VAC or higher

### Environment

- Operating temperature: 0 to 149°F (-18 to 65°C)
- Storage temperature: -40 to 185°F (-40 to 85°C)
- Relative humidity: 0 to 90%, non-condensing

### Agency Approvals

- cULus® UL/EN/CSA C22.2 No 61010-1 Listed, File E185611
- CSA C22.2 No. 24, File 158031
- UL® 50 4X indoor locations, NEMA 4X, IP66 front seal
- FM Class 3545
- CE, RoHS by design, W.E.E.E.
- EtherNet/IP™ and DeviceNet™ ODVA Conformance Tested

## Dimensional Drawings

### EZ-ZONE PM 1/32 DIN

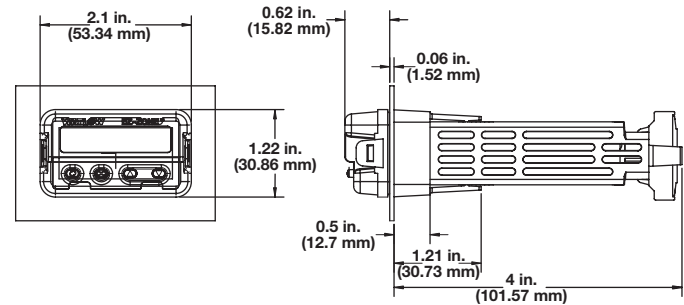

### EZ-ZONE PM 1/16 DIN

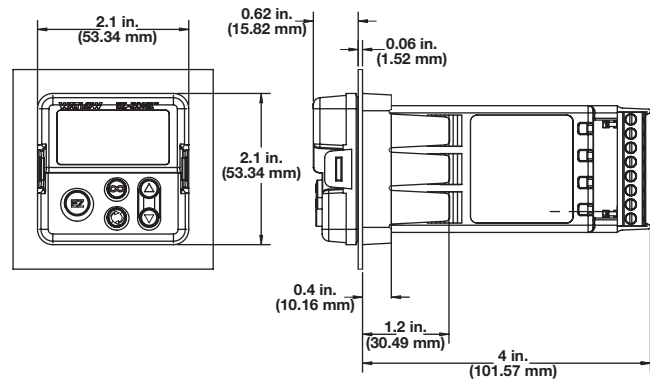

### EZ-ZONE PM 1/8 DIN - Horizontal

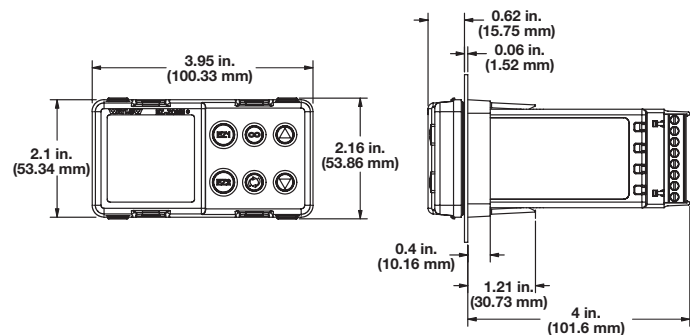

# Limits and Scanners

## EZ-ZONE PM Limit

### Dimensional Drawings (Continued)

EZ-ZONE PM 1/8 DIN - Vertical

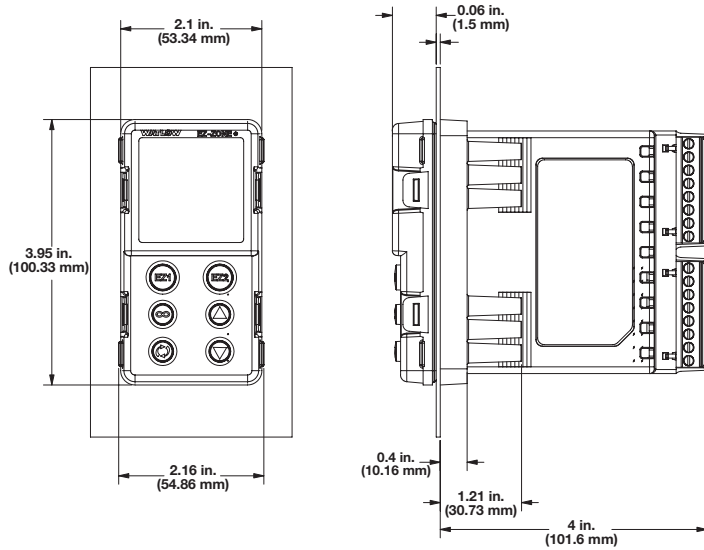

EZ-ZONE PM 1/4 DIN

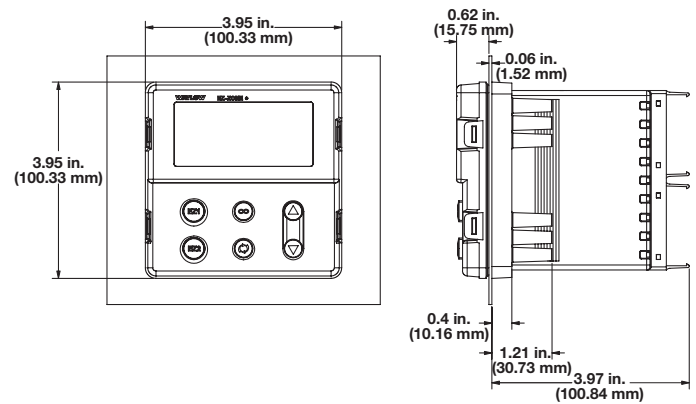

### EZ-ZONE Comparison Chart

	PM 1/32 DIN	PM 1/16 DIN	PM 1/8 DIN	PM 1/4 DIN
<b>Number of Digital Inputs/Outputs (DIO)</b>	0 to 2	0 to 2	0 to 2	0 to 2
<b>Number of Outputs</b>	1 to 4	1 to 6	1 to 6	1 to 6
<b>Maximum Power Output</b>	5A mechanical relay	5A mechanical relay	5A mechanical relay	5A mechanical relay
<b>Standard Bus Communications</b>	Yes	Yes	Yes	Yes
<b>Field Bus Communications</b>	Modbus® RTU 485	Modbus® RTU 232/485, EtherNet/ IP™, Modbus® TCP, DeviceNet™, PROFIBUS DP	Modbus® RTU 232/485, EtherNet/ IP™, Modbus® TCP, DeviceNet™, PROFIBUS DP	Modbus® RTU 232/485, EtherNet/ IP™, Modbus® TCP, DeviceNet™, PROFIBUS DP

# Limits and Scanners

## EZ-ZONE PM Limit

### Limit Model Ordering Information

- Universal sensor input, configuration communications
- Red green seven segment displays

#### Part Number

① ②	③	④	⑤	⑥ ⑦	⑧	⑨ ⑩ ⑪	⑫	⑬ ⑭
	Package Size	Primary Function	Power Supply, Digital I/O	Output 1 & 2 Hardware	Additional Communication Options		Isolated Input Options	Custom Options
PM					-	AAA		

③ Package Size	
3 =	1/32 DIN
6 =	1/16 DIN
8 =	1/8 DIN vertical
9 =	1/8 DIN horizontal
4 =	1/4 DIN

④ Primary Function	
L =	Limit controller with universal input
M =	Limit controller with thermistor input
D =	Custom firmware

⑤ Power Supply, Digital I/O	
1 =	100 to 240VAC
2 =	100 to 240VAC plus 2 digital I/O points
3 =	20 to 28VAC or 12 to 40VDC
4 =	20 to 28VAC or 12 to 40VDC plus 2 digital I/O points

⑥ ⑦ Output 1 and 2 Hardware Options		
	Output 1	Output 2
AJ =	None	Mechanical relay 5A, Form A
CJ =	Switched dc/open collector	Mechanical relay 5A, Form A
EJ =	Mechanical relay 5A, Form C	Mechanical relay 5A, Form A

⑧ Additional Communication Options, Standard Bus Always Included	
A =	None
1 =	EIA-485 Modbus® RTU

⑫ Isolated Input Options	
A =	None
D =	Isolated input 1

⑬ ⑭ Custom Options	
Firmware, Overlays, Parameter Settings	
AA =	Standard EZ-ZONE PM face plate
AB =	EZ-ZONE logo and no Watlow name
AC =	No logo and no Watlow name
AG =	Conformal coating

### Typical Block Diagram

#### EZ-ZONE PM Limit Model

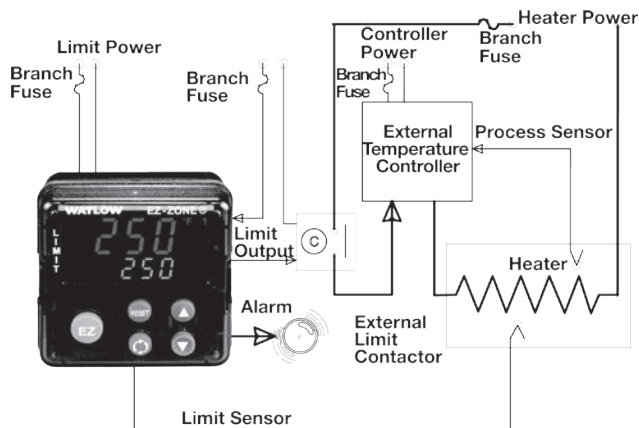



# Limits and Scanners

## EZ-ZONE PM Limit

### Enhanced Limit Model Ordering Information

- Universal sensor input, configuration communications
- Red green seven segment displays

#### Part Number

<b>① ②</b>	<b>③</b>	<b>④</b>	<b>⑤</b>	<b>⑥ ⑦</b>	<b>⑧</b>	<b>⑨</b>	<b>⑩ ⑪</b>	<b>⑫</b>	<b>⑬ ⑭</b>
	Package Size	Primary Function	Power Supply, Digital I/O	Output 1 & 2 Hardware	Additional Communication Options	Future Option	Output 3 & 4 Hardware	Isolated Input Options	Custom Options
<b>PM</b>					-	<b>A</b>			

③ Package Size	
6 =	1/16 DIN
8 =	1/8 DIN vertical
9 =	1/8 DIN horizontal
4 =	1/4 DIN

④ Primary Function	
L =	Limit controller with universal input
M =	Limit controller with thermistor input
D =	Custom firmware

⑤ Power Supply, Digital I/O	
1 =	100 to 240VAC
2 =	100 to 240VAC plus 2 digital I/O points
3 =	20 to 28VAC or 12 to 40VDC
4 =	20 to 28VAC or 12 to 40VDC plus 2 digital I/O points

⑥ ⑦ Output 1 and 2 Hardware Options		
	Output 1	Output 2
AJ =	None	Mechanical relay 5A, Form A
CJ =	Switched dc/open collector	Mechanical relay 5A, Form A
EJ =	Mechanical relay 5A, Form C	Mechanical relay 5A, Form A

⑧ Additional Communication Options, Standard Bus Always Included	
A =	None
1 =	EIA-485 Modbus® RTU
2 =	EIA-232/485 Modbus® RTU
3 =	EtherNet/IP™/Modbus® TCP
5 =	DeviceNet™
6 =	PROFIBUS DP

⑩ ⑪ Output 3 and 4 Hardware Options		
	Output 3	Output 4
AA =	None	None
AJ =	None	Mechanical relay 5A, Form A
AK =	None	SSR Form A, 0.5A
CA =	Switched dc/open collector	None
CC =	Switched dc/open collector	Switched dc
CJ =	Switched dc/open collector	Mechanical relay 5A, Form A
CK =	Switched dc/open collector	SSR Form A, 0.5A
EA =	Mechanical relay 5A, Form C	None
EC =	Mechanical relay 5A, Form C	Switched dc
EJ =	Mechanical relay 5A, Form C	Mechanical relay 5A, Form A
EK =	Mechanical relay 5A, Form C	SSR Form A, 0.5A
FA =	Universal process	None
FC =	Universal process	Switched dc
FJ =	Universal process	Mechanical relay 5A, Form A
FK =	Universal process	SSR Form A, 0.5A
KK =	SSR Form A, 0.5A	SSR Form A, 0.5A

<sup>1</sup>/<sub>16</sub> DIN Models: If communication options 2 thru 6 is ordered in previous digit, then Option AA must be ordered here.

⑫ Isolated Input Options	
A =	None
D =	Isolated input 1

⑬ ⑭ Custom Options	
Firmware, Overlays, Parameter Settings	
AA =	Standard EZ-ZONE PM face plate
AB =	EZ-ZONE logo and no Watlow name
AC =	No logo and no Watlow name
AG =	Conformal coating

# Limits and Scanners

## EZ-ZONE PM Express Limit

The EZ-ZONE PM Express panel mount limit controller from Watlow is an industry leading limit controller that allows for optimal performance utilizing simple over/under limit control and menu functionality without complex features. The EZ-ZONE PM Express limit controller is ideally suited for basic applications and usage levels.

The EZ-ZONE PM Express limit controller is the next generation of controllers leveraging the strong legacy of Watlow's SERIES 94, SERIES 945 and SERIES SD limit controllers where easy-to-use features are needed for basic applications. It includes one universal input and the option for up to two outputs and is available in 1/32, 1/16, 1/8 and 1/4 DIN panel mount packages.

The EZ-ZONE PM Express limit is a great addition to the EZ-ZONE PM family which includes two other controller versions, the EZ-ZONE PM integrated controller and the EZ-ZONE PM temperature and process controller. This family provides an ideal platform to perform many applications.

### Features and Benefits

#### Simplified menu

- Fits basic applications with a user-friendly interface supported by two menus and a streamlined list of parameters
- Eliminates user complexity often encountered when using more advanced limit controllers and their unnecessary features
- Reduces user training costs and programming errors

#### Standard bus communications

- Allows easy product configuration via PC communications protocol and free software
- Saves time, simplifies the programming process and improves reliability of the controller setup

#### Factory Mutual (FM) approved over and under limit with auxiliary outputs

- Increases user and equipment safety for over and under-temperature conditions

#### Agency approvals: UL® listed, CSA, CE, RoHS, W.E.E.E. FM, SEMI F47-0200

- Ensures prompt product acceptance
- Reduces end-product documentation costs



#### Front panel removable

- Saves time and labor for replacements and troubleshooting

#### P3T armor sealing system

- Complies to NEMA 4X, IP65
- Allows controller to be cleaned and washed
- Certified UL® 50 independent to NEMA 4X specification

#### Touch-safe package

- Increases installer and operator safety
- Complies with IP2X requirements

#### Consistent Termination Labeling (CTL) connection system

- Simplifies switching between products
- Speeds up user's system documentation

#### Three-year warranty

- Ensures product support and protection

#### High-ampere power control output

- Drives 5 ampere resistive loads direct
- Reduces component count
- Saves panel space and simplifies wiring
- Decreases ownership cost

# Limits and Scanners

## EZ-ZONE PM Express Limit

### Specifications

#### Line Voltage/Power

- 85 to 264VAC, 47 to 63Hz
- 20 to 28VAC, +10/-15%; 50/60Hz,  $\pm 5\%$
- 12 to 40VDC
- 10VA ( $1/32$  and  $1/16$  DIN) 14VA ( $1/8$  and  $1/4$  DIN) max. power consumption
- Data retention upon power failure via non-volatile memory
- Compliant with SEMI F47-0200, Figure R1-1 voltage sag requirements @ 24VAC or higher

#### Environment

- 0 to 149°F (-18 to 65°C) operating temperature
- -40 to 185°F (-40 to 85°C) storage temperature
- 0 to 90% RH, non-condensing

#### Accuracy

- Calibration accuracy and sensor conformity:  $\pm 0.1\%$  of span,  $\pm 1^\circ\text{C}$  @ the calibrated ambient temperature and rated line voltage
  - Type S: 0.2%
  - Type T: below  $-50^\circ\text{C}$ ; 0.2%
- Calibration ambient temperature @ 77°F  $\pm 5^\circ\text{F}$  ( $25^\circ\text{C} \pm 3^\circ\text{C}$ )
- Accuracy span: 1000°F ( $540^\circ\text{C}$ ) min.
- Temperature stability:  $\pm 0.1^\circ\text{F}/^\circ\text{F}$  ( $\pm 0.1^\circ\text{C}/^\circ\text{C}$ ) rise in ambient max.

#### Agency Approvals

- cULus® UL/EN/CSA C22.2 No 61010-1 Listed, File E185611
- CSA C22.2 No. 24, File 158031
- UL® 50 4X indoor locations, NEMA 4X, IP66 front seal
- FM Class 3545
- CE, RoHS by design, W.E.E.E.

#### Serial Communications

- Isolated communications
  - Standard bus configuration protocol

#### Wiring Termination—Touch-Safe Terminals

- Input, power and controller output terminals are touch safe, removable, 12 to 22 AWG

#### Universal Input

- Thermocouple, grounded or ungrounded sensors, greater than 20M $\Omega$  input impedance, 3 $\mu\text{A}$  open sensor detection, 2k $\Omega$  source resistance max.
- RTD 2- or 3-wire, platinum, 100 $\Omega$  @ 32°F ( $0^\circ\text{C}$ ) calibration to DIN curve (0.00385 $\Omega/\Omega/^\circ\text{C}$ )
- Process, 4-20mA @ 100 $\Omega$ , or 0-10VDC @ 20k $\Omega$  input impedance; scalable

### Functional Operating Range

Type J: -346 to 2192°F (-210 to 1200°C)  
Type K: -328 to 2500°F (-200 to 1370°C)  
Type T: -328 to 750°F (-200 to 400°C)  
Type N: -328 to 2372°F (-200 to 1300°C)  
Type S: -58 to 3214°F (-50 to 1767°C)  
RTD (DIN): -328 to 1472°F (-200 to 800°C)  
Process: -1999 to 9999 units

### Output Hardware

- Switched dc = 22 to 32VDC @ 30mA
- Switched dc/open collector = 30VDC max. @ 100mA max. current sink
- Solid state relay (SSR), Form A, 0.5A @ 24VAC min., 264VAC max., opto-isolated, without contact suppression
- Electromechanical relay, Form C, 5A, 24 to 240VAC or 30VDC max., resistive load, 100,000 cycles at rated load
- Electromechanical relay, Form A, 5A, 24 to 240VAC or 30VDC max., resistive load, 100,000 cycles at rated load
- NO-ARC relay, Form A, 15A, 24 to 240VAC, no VDC, resistive load, 2 million cycles at rated load
- Universal process, Output range selectable:  
0 to 10VDC into a min. 1,000 $\Omega$  load  
4 to 20mA into max. 800 $\Omega$  load

### Operator Interface

- Dual 4 digit, 7 segment LED displays
- Typical display update rate 1Hz
- Advance, RESET, up and down keys plus an EZ-KEY (not available in  $1/32$  DIN)

## EZ-ZONE PM Express Limit

### Typical Block Diagrams

EZ-ZONE PM EXPRESS Limit Model

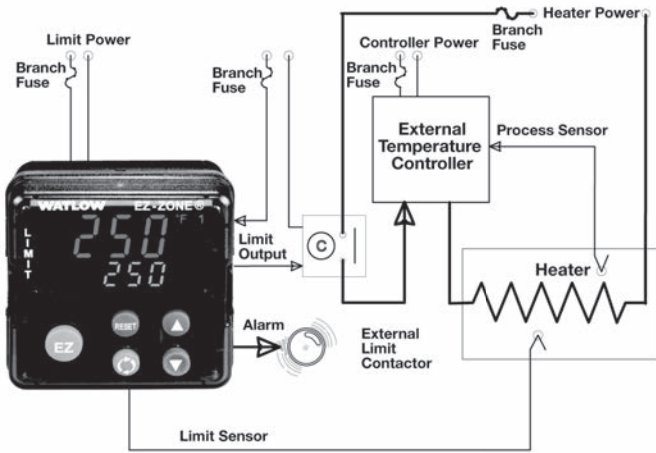

### Dimensional Drawings

EZ-ZONE PM 1/32 DIN

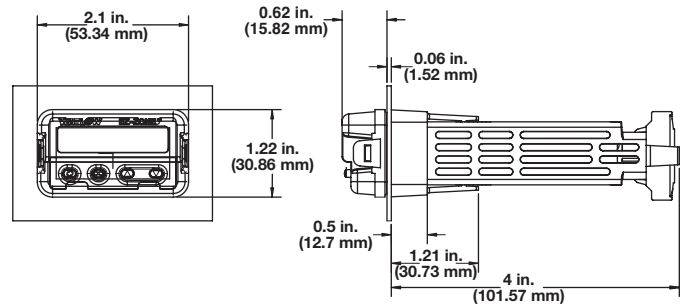

EZ-ZONE PM 1/16 DIN

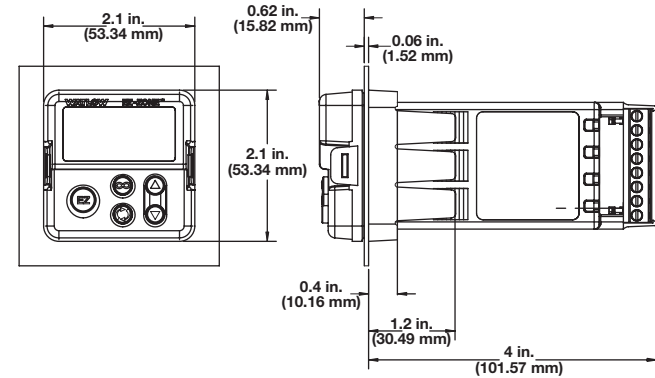

# Limits and Scanners

## EZ-ZONE PM Express Limit

### Ordering Information

All models include:

- Universal sensor input, standard bus configuration communications
- Dual line red over green seven segment displays

#### Part Number

① ②	③	④	⑤	⑥ ⑦	⑧ ⑨ ⑩ ⑪	⑫	⑬ ⑭
	Package Size	Primary Function	Power Supply	Output 1 & 2 Hardware	Future Option	Menu Type	Additional Options
PM		L			- AAAA	B	

③ Package Size	
3 =	1/32 DIN
6 =	1/16 DIN
8 =	1/8 DIN vertical (future option)
9 =	1/8 DIN horizontal (future option)
4 =	1/4 DIN (future option)

④ Primary Function	
L =	Limit controller with universal input

⑤ Power Supply, Digital I/O	
1 =	100 to 240VAC
3 =	20 to 28VAC or 12 to 40VDC

⑥ ⑦ Output 1 and 2 Hardware Options		
	Output 1	Output 2
AJ =	None	Mechanical relay 5A, Form A
CJ =	Switched dc/open collector	Mechanical relay 5A, Form A
EJ =	Mechanical relay 5A, Form C	Mechanical relay 5A, Form A

⑫ Menu Type	
B =	PM EXPRESS with English manual

⑬ ⑭ Additional Options	
AA =	Standard EZ-ZONE PM face plate
AB =	EZ-ZONE logo, no Watlow name
AC =	No logo, no Watlow name
AG =	Conformal coating

# Limits and Scanners

## SERIES LV

Watlow's family of microprocessor-based limit controllers provides an economical solution for applications requiring temperature limit control. Limits are available in a broad range of packaging options, allowing selection of the best version for an application. Limits are available with an operator interface and can be ordered in 1/8 DIN-square panel mount or DIN-rail mount design configurations.

The SERIES LV limit family incorporates a microprocessor design platform. This design provides significant improvements in the performance, repeatability and accuracy offered by Watlow's current line of analog limit controllers.

The variable SERIES LV limit includes an operator interface for viewing and selecting the set point. A red, four-character seven segment LED displays the set point. Set point selection is made with a continuous turn rotary encoder. Operating range temperature values are customer defined in the product configuration part number.

The limit controllers are factory mutual (FM) approved with special UL® approval for the open board potted versions. Watlow's limit controllers include industry leading service and support and are protected by a three-year warranty.



### Features and Benefits

#### Adjustable set points

- Offers control flexibility

#### Four character LED display

- Improves set point selection accuracy

#### Multiple mounting options

- Minimizes installation time

#### High or low limit with auto or manual reset

- Provides application flexibility

#### Fahrenheit or Celsius operation with indication

- Offers application flexibility

#### Sensor break protection

- Provides positive system shutdown

#### Agency approvals

- Meets certification requirements/compliance

#### Microprocessor based technology

- Ensures accurate, repeatable control

# Limits and Scanners

## SERIES LV

### Specifications

#### Limit Controller

- Microprocessor-based limit controller
- Nominal switching hysteresis, typically 3°F (1.7°C)
- High or low limit, factory selectable
- Latching output requires manual reset upon over or under temperature condition
- Manual or automatic reset on power loss, factory selectable
- Internal front panel or external customer supplied momentary reset switch
- Input filter time: 1 second

#### Operator Interface

- Four digit, seven segment LED displays, 0.28 in. (7 mm) high
- °F or °C indicator LED
- Alarm indicator LED
- Continuous turn, velocity sensitive rotary encoder for set point adjustment
- Front panel SET/RESET

#### Standard Conditions For Specifications

- Rated line voltage, 50 to 60Hz, 0 to 90% RH non-condensing, 15-minute warm-up
- Calibration ambient range: 77°F (25°C) ±3°C

#### Sensor Input

##### Thermocouple

- Grounded or ungrounded
- Type E, J, K, T thermocouple
- >10 MΩ input impedance
- 250 nV input referenced error per 1Ω source resistance

##### RTD

- 2-wire platinum, 100Ω
- DIN-curve (0.00385 curve)
- 125μA nominal RTD excitation current

#### Input Accuracy Span Range

Type E:	-328 to 1470°F	(-200 to 800°C)
Type J:	32 to 1382°F	(0 to 750°C)
Type K:	-328 to 2282°F	(-200 to 1250°C)
Type T:	-328 to 662°F	(-200 to 350°C)
RTD (DIN)	-328 to 1472°F	(-200 to 800°C)

#### Thermocouple Input

- Calibration accuracy: ±1% of input accuracy span, ±1° at standard conditions and actual calibration ambient. Exception: Type T, ±2.4% of input accuracy span for -328 to 32°F (-200 to 0°C)
- Temperature stability: ±0.3° per degree change in ambient

#### RTD Input

- Calibration accuracy ±1% of input accuracy span ±1° at standard conditions and actual calibration ambient
- Temperature stability: ±0.2° per degree change in ambient

#### Allowable Operating Ranges

Type E:	-328 to 1470°F	(-200 to 800°C)
Type J:	-346 to 1900°F	(-210 to 1038°C)
Type K:	-454 to 2500°F	(-270 to 1370°C)
Type T:	-454 to 750°F	(-270 to 400°C)
RTD (DIN)	-328 to 1472°F	(-200 to 800°C)

#### Electromechanical Relay, Form C

- Min. load current: 100mA
- 8A @ 240VAC or 30VDC max., resistive
- 250VA pilot duty, 120/240VAC max., inductive
- Use RC suppression for inductive loads
- Electrical life 100,000 cycles at rated current

#### External Reset Switch

- Momentary, dry contact closure

#### Agency Approvals

##### SERIES LV (potted version only)

- UL® 991 recognized temperature limit for cooking industry
- UL® 60730-1

##### SERIES LV (including potted version)

- UL® 873 recognized temperature regulator
- UL® 197 reviewed for use in cooking appliances
- UL® 991
- UL® 50 IP65 for tactile key models
- ANSI Z21.23 Gas appliance thermostat approval
- CSA C22.2#24 approved limit control
- FM Class 3545 temperature limit switches
- RoHS, WEEE

#### Terminals

- 0.25 in. (6.3 mm) quick connect, push on terminal or removable screw terminals

#### Power

- 24VAC +10%; -15%; 50/60Hz, ±5%
- 120VAC +10%; -15%; 50/60Hz, ±5%
- 230 to 240VAC +10%; -15%; 50/60Hz, ±5%
- 10VA max. power consumption
- Data retention upon power failure via nonvolatile memory

#### Operating Environment

- 32 to 158°F (0 to 70°C)
- 0 to 90% RH, non-condensing
- Storage temperature: -40 to 185°F (-40 to 85°C)

# Limits and Scanners

## SERIES LV

### Specifications (Continued)

#### Dimensions

- DIN-rail model can be DIN-rail or chassis mount  
DIN-rail spec DIN 50022, 1.38 in. x 0.30 in. (35 mm x 7.5 mm)

Style	Width	Height	Depth
DIN-rail	3.08 in. (78.1 mm)	4.42 in. (112.3 mm)	3.57 in. (90.7 mm)
Square 1/8 DIN-panel	2.85 in. (72.4 mm)	2.85 in. (72.4 mm)	Behind panel 2.04 in. (51.7 mm)

### Ordering Information

- Limit controller with 8A relay output, rotary set point adjustment, four character, seven segment display, reset switch

#### Part Number

① ②	③	④	⑤	⑥	⑦ ⑧ ⑨ ⑩	⑪ ⑫ ⑬ ⑭	⑮
	Power Supply	Package	Sensor Type and Scale	Limit Type	Low Set Point	High Set Point	Overlay/Custom Options
LV							

③ Power Supply	
C =	120VAC
E =	230 to 240VAC
G =	24VAC

④ Package	
1 =	Panel mount square 1/8 DIN - spade terminals
2 =	DIN-rail mount - spade terminals
5 =	Panel mount square 1/8 DIN - screw terminals
6 =	DIN-rail mount - screw terminals
A =	NEMA 4X panel mount, tactile keys (spade terminals)
B =	DIN-rail mount, tactile keys (spade terminals)
C =	NEMA 4X panel mount, tactile keys (screw terminals)
D =	DIN-rail mount, tactile keys (screw terminals)

⑤ Sensor Type and Scale	
H =	T/C Type J Fahrenheit (-346 to 1900°F)
J =	T/C Type J Celsius (-210 to 1038°C)
K =	T/C Type K Fahrenheit (-454 to 2500°F)
L =	T/C Type K Celsius (-270 to 1370°C)
M =	T/C Type T Fahrenheit (-454 to 750°F)
N =	T/C Type T Celsius (-270 to 400°C)
P =	RTD Fahrenheit (-328 to 1472°F)
R =	RTD Celsius (-200 to 800°C)
S =	T/C Type E Fahrenheit (-328 to 1470°F)
T =	T/C Type E Celsius (-200 to 800°C)

⑥ Limit Type	
U =	High limit manual reset
W =	High limit auto reset
Y =	Low limit manual reset
Z =	Low limit auto reset

⑦ ⑧ ⑨ ⑩ Low Set Point Operating Range Value	
<b>Note:</b> A (-) is used in the left most digit of the set point operating ranges to indicate a negative temperature value.	

⑪ ⑫ ⑬ ⑭ High Set Point Operating Range Value	
<b>Note:</b> A (-) is used in the left most digit of the set point operating ranges to indicate a negative temperature value.	

⑮ Overlay/Custom Options	
A =	Standard with Watlow logo
1 =	Standard without Watlow logo



# Limits and Scanners

## SERIES LF

Watlow's family of microprocessor-based limit controllers provide an economical solution for applications requiring temperature limit control. Limits are available in a broad range of packaging options, allowing selection of the best version for an individual application. Controllers are available without an operator interface and can be ordered in square 1/8 DIN-panel mount, DIN-rail mount or open board design configurations.

The SERIES LF limit family incorporates a microprocessor design platform. This design provides significant improvements in the performance, repeatability and accuracy offered by Watlow's current line of analog basic temperature controllers.

The SERIES LF limit offers fixed set points and can be supplied with or without an operator interface. Operating set point temperature values are customer defined in the product configuration part number.

The LF limit controllers are factory mutual (FM) approved with special UL® approval for the open board potted versions. Watlow's limit controllers include industry leading service and support and are protected by a three-year warranty.

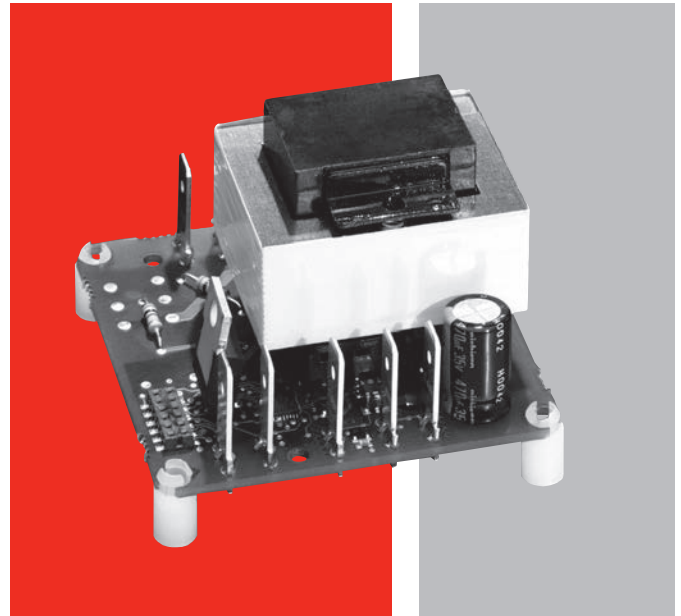

### Features and Benefits

#### Fixed set points

- Provides tamper-proof operation

#### Multiple mounting options

- Minimizes installation time

#### High or low limit with auto or manual reset

- Provides application flexibility

#### Fahrenheit or Celsius operation with indication

- Offers application flexibility

#### Sensor break protection

- Provides positive system shutdown

#### Agency approvals

- Meets certification requirements/compliance

#### Microprocessor based technology

- Ensures accurate, repeatable control

# Limits and Scanners

## SERIES LF

### Specifications

#### Limit Controller

- Microprocessor based, limit controller
- Nominal switching hysteresis, typically 3°F (1.7°C)
- High or low limit, factory selectable
- Latching output requires manual reset upon over or under temperature condition
- Manual or automatic reset on power loss, factory selectable
- External customer supplied momentary reset switch
- Input filter time: 1 second

#### Standard Conditions For Specifications

- Rated line voltage, 50 to 60Hz, 0 to 90% RH non-condensing, 15-minute warm-up
- Calibration ambient range: 77°F (25°C) ±3°C

#### Sensor Input

##### Thermocouple

- Grounded or ungrounded
- Type E, J, K, T thermocouple
- >10 MΩ input impedance
- 250 nV input referenced error per 1Ω source resistance

##### RTD

- 2-wire platinum, 100Ω
- DIN-curve (0.00385 curve)
- 125μA nominal RTD excitation current

#### Input Accuracy Span Range

Type E:	-328 to 1470°F	(-200 to 800°C)
Type J:	32 to 1382°F	(0 to 750°C)
Type K:	-328 to 2282°F	(-200 to 1250°C)
Type T:	-328 to 662°F	(-200 to 350°C)
RTD (DIN)	-328 to 1472°F	(-200 to 800°C)

#### Thermocouple Input

- Calibration accuracy: ±1% of input accuracy span, ±1° at standard conditions and actual calibration ambient. Exception: Type T, ±2.4% of input accuracy span for -328 to 32°F (-200 to 0°C)
- Temperature stability: ±0.3° per degree change in ambient

#### RTD Input

- Calibration accuracy ±1% of input accuracy span ±1° at standard conditions and actual calibration ambient
- Temperature stability: ±0.2° per degree change in ambient

#### Allowable Operating Ranges

Type E:	-328 to 1470°F	(-200 to 800°C)
Type J:	-346 to 1900°F	(-210 to 1038°C)
Type K:	-454 to 2500°F	(-270 to 1370°C)
Type T:	-454 to 750°F	(-270 to 400°C)
RTD (DIN)	-328 to 1472°F	(-200 to 800°C)

#### Output Types

##### Electromechanical Relay, Form C

- Min. load current: 100mA
- 8A @ 240VAC or 30VDC max., resistive
- 250VA pilot duty, 120/240VAC max., inductive
- Use RC suppression for inductive loads
- Electrical life 100,000 cycles at rated current

##### External Reset Switch

- Momentary, dry contact closure

#### Agency Approvals

##### SERIES LF (potted version only)

- UL® 991 recognized temperature limit for cooking industry
- UL® 60730-1

##### SERIES LF (including potted version)

- UL® 873 recognized temperature regulator
- UL® 197 reviewed for use in cooking appliances
- UL® 991
- ANSI Z21.23 gas appliance thermostat approval
- CSA C22.2 #24 approved limit control
- FM Class 3545 temperature limit switches
- RoHS, W.E.E.E.

#### Terminals

- 0.25 in. (6.3 mm) quick connect, push on terminal or removable screw terminals

#### Power

- 24VAC +10%; -15%; 50/60Hz, ±5%
- 120VAC +10%; -15%; 50/60Hz, ±5%
- 230 to 240VAC +10%; -15%; 50/60Hz, ±5%
- 10VA max. power consumption
- Data retention upon power failure via nonvolatile memory

#### Operating Environment

- 32 to 158°F (0 to 70°C)
- 0 to 90% RH, non-condensing
- Storage temperature: -40 to 185°F (-40 to 85°C)

#### Dimensions

- DIN-rail model can be DIN-rail or chassis mount  
DIN-rail spec DIN 50022, 1.38 in. x 0.30 in.  
(35 mm x 7.5 mm)

Style	Width	Height	Depth
Open Board	2.43 in. (61.7 mm)	2.43 in. (61.7 mm)	1.78 in. (45.1 mm)
Potted	2.76 in. (70.1 mm)	4.05 in. (102.9 mm)	1.84 in. (46.6 mm)
DIN-rail	3.08 in. (78.1 mm)	4.42 in. (112.3 mm)	3.57 in. (90.7 mm)
Square ¼ DIN-panel	2.85 in. (72.4 mm)	2.85 in. (72.4 mm)	Behind panel 2.04 in. (51.7 mm)

# Limits and Scanners

## SERIES LF

### Ordering Information

- Limit controller with 8A relay output, fixed set point

#### Part Number

<b>① ②</b>	<b>③</b>	<b>④</b>	<b>⑤</b>	<b>⑥</b>	<b>⑦ ⑧ ⑨ ⑩</b>	<b>⑪ ⑫ ⑬ ⑭</b>	<b>⑮</b>
	Power Supply	Package	Sensor Type and Scale	Limit Type	Fixed Set Point Temp. Value		Overlay/Custom Options
LF						AAAA	

③ Power Supply	
C =	120VAC
E =	230 to 240VAC
G =	24VAC

④ Package	
1 =	Panel mount square 1/8 DIN - spade terminals
2 =	DIN-rail mount - spade terminals
3 =	Open, non potted - spade terminals
4 =	Potted case - spade terminals
5 =	Panel mount square 1/8 DIN - screw terminals
6 =	DIN-rail mount - screw terminals
7 =	Open, non potted - screw terminals

⑤ Sensor Type and Scale	
H =	T/C Type J Fahrenheit (-346 to 1900°F)
J =	T/C Type J Celsius (-210 to 1038°C)
K =	T/C Type K Fahrenheit (-454 to 2500°F)
L =	T/C Type K Celsius (-270 to 1370°C)
M =	T/C Type T Fahrenheit (-454 to 750°F)
N =	T/C Type T Celsius (-270 to 400°C)
P =	RTD Fahrenheit (-328 to 1472°F)
R =	RTD Celsius (-200 to 800°C)
S =	T/C Type E Fahrenheit (-328 to 1470°F)
T =	T/C Type E Celsius (-200 to 800°C)

⑥ Limit Type	
U =	High limit manual reset
W =	High limit auto reset
Y =	Low limit manual reset
Z =	Low limit auto reset

⑦ ⑧ ⑨ ⑩ Fixed Set Point Temperature Value	
<b>Note:</b> A (-) is used in the left most digit of the set point operating ranges to indicate a negative temperature value.	

⑮ Overlay/Custom Options	
A =	Standard with Watlow logo
1 =	Standard without Watlow logo

# Limits and Scanners

## SERIES LS Safety Limit

As manufacturers are required to meet tighter safety standards, Watlow has addressed this need with its new SERIES LS safety limit. This new limit meets UL® 1998 and EN 60730 safety requirements and will shut down a system to prevent damage to equipment or injury to personnel.

Watlow's SERIES LS is recommended for any application where control failure could cause the temperature of the application to continue to increase resulting in large product scrap costs, damage to system equipment or potential fire hazard.

The SERIES LS provides increased safety due to the use of a factory fixed set point, factory fixed hysteresis and the use of redundant temperature sensors to protect against a single point sensor failure. Either sensor can initiate an overtemperature limit condition along with a deviation between sensors greater than the process comparison value.

Watlow's new SERIES LS offers fixed limit set point temperature values that are customer definable in the product configuration part number. It is available with a potted module design configuration and push-on, quick connect spade terminals to provide the electrical connections.

### Features and Benefits

#### Fixed limit set point

- Provides tamper-proof operation
- Offers control flexibility

#### Dual channel sensors

- Detects sensor faults
- Provides a fail-safe design
- Verifies firmware
- Prevents sensor deviation and sensor placement errors

#### High-limit operation

- Provides application flexibility

#### Fahrenheit or Celsius operation

- Delivers application flexibility

#### Sensor break protection

- Offers positive system shutdown

#### Agency approvals

- Meets certification requirements/compliance

#### Microprocessor-based technology

- Ensures accurate, repeatable protection

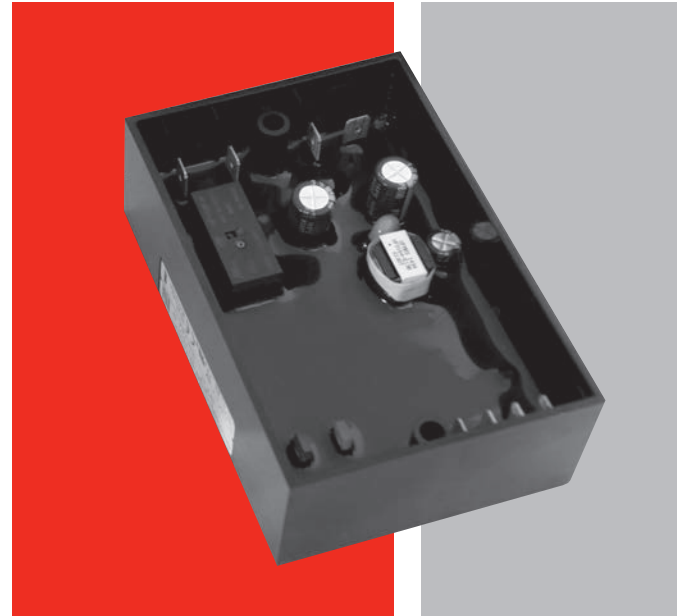

#### Status notification

- Signals user of status with two integrated LEDs
- Provides health check signal to inform operator that the process is working correctly

#### Three-year warranty

- Ensures product support and reliability

#### Typical Applications

- Foodservice equipment
- Industrial machinery
- Medical equipment
- Packaging equipment
- Plastics processing equipment

# Limits and Scanners

## SERIES LS Safety Limit

### Specifications

#### Controller

- Microprocessor based, limit controller
- Customer defined hysteresis, model number dependent
- High limit, factory selectable
- Automatic reset on power loss
- Input filter time: 1 second

#### Thermocouple Sensor Input

- Ungrounded
- Type J and K thermocouple types
- >10 MΩ input impedance

#### Input Accuracy Span Range

- Type J: 0 to 764°F (-18 to 406°C)
- Type K: 0 to 999°F (-18 to 537°C)
- Calibration accuracy: ±6°C, ±1° at standard conditions and actual calibration ambient
- Temperature stability: ±0.3 degree per degree change in ambient

#### Allowable Operating Ranges

- Type J: 32 to 626°F (0 to 330°C)
- Type K: 32 to 820°F (0 to 438°C)

#### Output Types

- Electromechanical relay, Form A, minimum load current: 100mA, 8A resistive load, 120VA pilot duty, 120/240VAC maximum, inductive, electrical life 6,000 cycles at rated current

#### Terminals

- 0.25 in. (6.4 mm) quick connect, push-on terminals

### Agency Approvals

- UL® / EN 60730-1, 2, 9 automatic electronic controls for household and similar use. File #E43684
- UL® 1998 software review class B
- W.E.E.E.; CE – see Declaration of Conformity
- RoHS directive (2011-65-EU)

### Power

- 100-240VAC +10%; -15%; 50/60Hz, ±5%
- 10VA maximum power consumption
- Data retention upon power failure via nonvolatile memory

### Environment

- Operating temperature: 32 to 158°F (0 to 70°C)
- Storage temperature: -40 to 185°F (-40 to 85°C)
- Relative humidity: 0 to 90% RH, non-condensing

### Dimensional Drawing

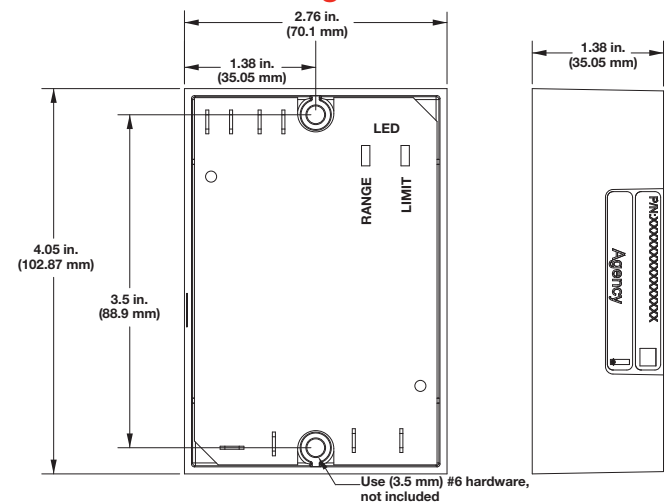

### Ordering Information

#### Part Number

① ②	③	④	⑤	⑥	⑦ ⑧ ⑨ ⑩	⑪ ⑫ ⑬	⑭ ⑮
LS	Set Point	Package	Sensor Type and Scale	Limit Type	High Set Point Temp. Value	Hysteresis	Custom Options
LS	F	4		W			AA

③	Set Point
F =	Fixed set point

④	Package
4 =	Potted case, spade terminals

⑤	Sensor Type and Scale
H =	T/C Type J Fahrenheit (32 to 626°F)
J =	T/C Type J Celsius (0 to 330°C)
K =	T/C Type K Fahrenheit (32 to 820°F)
L =	T/C Type K Celsius (0 to 438°C)

⑥	Limit Type
W =	High limit, power cycle to reset

⑦ ⑧ ⑨ ⑩	High Set Point Temperature Value
XXXX =	A zero (0) is used in the left most digit of the set point

⑪ ⑫ ⑬	Hysteresis
XXX =	The temperature differential below the limit set point at which a reset is possible. Limit high set point - hysteresis must be greater than or equal to the low sensor range

⑭ ⑮	Custom Options
AA =	Standard

# Limits and Scanners

## TLM SERIES

The Watlow TLM series is a compact, cost-effective solution for multi-channel, redundant temperature monitoring. Each TLM has eight channels to continuously monitor thermocouples, RTDs, or thermal switches, making it ideal for multi-zone applications. Choose an individual temperature limit for each channel from the standard list or consult the factory for other limits.

The TLM is equipped with flexible interlocks, which are designed to interface with redundant controls. The alarms latch and require operator intervention to clear for process and equipment protection. Semiconductor capital equipment OEMs will find these features ideal for meeting SEMI S2 safety guidelines.

The TLM is compact and easy to install on a panel or a DIN-rail. No cutout is required, reducing installation and fabrication costs. Troubleshooting is simplified through a self-test diagnostics input, which simulates the alarm state. The TLM-8 is FM approved as a temperature limit switch, bears the CE mark (LVD and EMC Directives) and is UL® and C-UL® listed.



### Features and Benefits

#### Multi-channel monitoring

- Eight channels in one package make the TLM ideal for multi-zone applications

#### Multiple sensor types

- TLM accepts six thermocouple types, RTDs and thermal switches (one sensor type per TLM unit)

#### Selectable alarm limits

- TLM-8 can be ordered with a different temperature limit on each channel

#### Compact, easy-to-install, sub-panel mounting

- Reduces installation time

#### Flexible interlocks

- Interfaces with redundant controls; ideal for SEMI S2 applications

#### Self-test diagnostics

- Simplifies troubleshooting

#### Latching alarms

- Protects process and equipment

#### CE, UL®, C-UL® and Factory Mutual (FM) Approvals

- Global acceptance for safety and EMC compliance

### Typical Applications

- Any process requiring multi-channel redundant temperature monitoring
- Semiconductor capital equipment requiring SEMI S2
- Electronics packaging equipment
- Plastic injection molding and extrusion equipment

# Limits and Scanners

## TLM SERIES

### Specifications

#### Analog Inputs

- Number of sensor inputs: 8

#### Sensor Inputs (Trip Point Ranges)

- RTD 100Ω, platinum, 2-wire (DIN Curve): -100 to 850°C)
- Thermal switch
- Type E T/C (100 to 801°C)
- Type J T/C (100 to 754°C)
- Type K T/C (100 to 1205°C)
- Type R T/C (500 to 1720°C)
- Type S T/C (500 to 1711°C)
- Type T T/C (100 to 384°C)

#### Accuracy

- Part numbers starting with “TLME”: ±5 percent of trip point
- Part numbers starting with “TLMC”: see table below

#### TLMC Accuracy Specification

Sensor(s)	Trip Point Accuracy Ambient: 15 to 35°C	Trip Point Accuracy Ambient: 0 to 60°C
J, K, E, T, RTD	±0.5% of trip point ±2°C	±0.5% of trip point ±4°C
S, R	±0.5% of trip point ±3°C	±0.5% of trip point ±5°C

#### Repeatability

- Better than 5°C or accuracy for trip point, whichever is less

#### Digital Inputs

- Alarm acknowledge digital input: 5-30VDC, optically isolated
- Alarm simulation digital input: 5-30VDC, optically isolated

#### Electromechanical Alarm Relays

- Contact arrangement: open in power off condition
- Contact action: latch open in alarm condition
- Maximum contact rating: 1A @ 30VDC

#### Indicator Lights

- 8 individual red alarm status indicator lights
- 1 green supply power indicator light

#### Dimensions

- 9.30 in. (236 mm) x 3.61 in. (92 mm) x 1.87 in. (48 mm) depth; add 0.75 in. (20 mm) to depth for DIN-rail mount

#### Power Requirements

- 12-24VDC, 3.2 watts, class 2 power supply

#### Environmental

- Temperature: 0 to 60°C (operating); -20 to 100°C (storage)
- Relative humidity: 0-95 percent, non-condensing

#### Agency Approvals/Compliance

- UL®, C-UL® listed (File No. E185611)  
Process Control Equipment UL® 61010  
Process Control Equipment C22.2 #61010-1
- FM  
Temperature Limit Switches-Non Indicating Class 3545  
Temperature Supervisory Switch Class 3545
- CE  
Low Voltage Directive (LVD) 2006-95-EC  
Electromagnetic Compatibility Directive (EMC) 2004/108/EC

### Ordering Information

#### Part Number

①	②	③	④	⑤	⑥	⑦	⑧	⑨	⑩	⑪	⑫	⑬	⑭	⑮
TLME				Sensor Type	Alarm Relays	Mounting	Channel 1	Channel 2	Channel 3	Channel 4	Channel 5	Channel 6	Channel 7	Channel 8

⑤	Sensor Type
0 =	RTD or thermostatic switch
1 =	Type E T/C
2 =	Type J T/C
3 =	Type K T/C
4 =	Type R T/C
5 =	Type S T/C
6 =	Type T T/C

⑥	Alarm Relays
0 =	Global relays only
1 =	Global alarm relays and 8 channel alarm relays

⑦	Mounting
0 =	Panel
1 =	DIN-rail

⑧ ⑨ ⑩ ⑪ ⑫ ⑬ ⑭ ⑮	Trip Points
Based on your sensor choice, use the Trip Point Chart on the next page and choose the desired alarm temperature for each channel.	

# Limits and Scanners

## TLM SERIES

### Trip Point Chart

Temperature	Trip Point
<b>RTD</b>	
Unused Input	A
103°C (217°F)	B
121°C (250°F)	C
151°C (304°F)	D
215°C (419°F)	E
324°C (615°F)	F
404°C (759°F)	G
478°C (892°F)	H
584°C (1083°F)	I
708°C (1306°F)	J
824°C (1515°F)	K
Thermostatic switch	K
<b>Type E T/C</b>	
Unused Input	A
101°C (214°F)	B
202°C (396°F)	C
302°C (576°F)	D
403°C (756°F)	E
502°C (936°F)	F
600°C (1112°F)	G
702°C (1296°F)	H
801°C (1474°F)	I
<b>Type J T/C</b>	
Unused Input	A
100°C (212°F)	B
152°C (307°F)	C
202°C (396°F)	D
251°C (484°F)	E
302°C (576°F)	F
350°C (662°F)	G
402°C (756°F)	H
450°C (842°F)	I
502°C (936°F)	J
554°C (1027°F)	K
600°C (1112°F)	L
653°C (1207°F)	M
704°C (1299°F)	N
754°C (1389°F)	O

Temperature	Trip Point
<b>Type K T/C</b>	
Unused Input	A
100°C (212°F)	B
150°C (302°F)	C
200°C (392°F)	D
252°C (486°F)	E
303°C (577°F)	F
353°C (667°F)	G
401°C (754°F)	H
455°C (851°F)	I
504°C (939°F)	J
556°C (1033°F)	K
603°C (1117°F)	L
651°C (1204°F)	M
701°C (1294°F)	N
753°C (1387°F)	O
807°C (1485°F)	P
851°C (1564°F)	Q
907°C (1665°F)	R
952°C (1746°F)	S
998°C (1828°F)	T
1057°C (1935°F)	U
1101°C (2014°F)	V
1157°C (2115°F)	W
1205°C (2201°F)	X
<b>Type R T/C</b>	
Unused Input	A
501°C (934°F)	B
602°C (1116°F)	C
708°C (1306°F)	D
800°C (1472°F)	E
903°C (1657°F)	F
999°C (1830°F)	G
1100°C (2012°F)	H
1206°C (2203°F)	I
1306°C (2383°F)	J
1410°C (2570°F)	K
1497°C (2727°F)	L
1593°C (2899°F)	M
1720°C (3128°F)	N

Temperature	Trip Point
<b>Type S T/C</b>	
Unused Input	A
506°C (943°F)	B
601°C (1114°F)	C
700°C (1292°F)	D
810°C (1490°F)	E
902°C (1656°F)	F
1005°C (1841°F)	G
1110°C (2030°F)	H
1210°C (2210°F)	I
1313°C (2395°F)	J
1404°C (2559°F)	K
1500°C (2732°F)	L
1600°C (2912°F)	M
1711°C (3112°F)	N
<b>Type T T/C</b>	
Unused Input	A
100°C (212°F)	B
202°C (396°F)	C
291°C (556°F)	D
384°C (723°F)	E

**Please Note:** Trip point values and specifications have changed from earlier TLM-8 versions. Please contact the factory if ordering replacement units for models not beginning with TLME.

**Note:** For other trip points and higher trip point accuracy, consult your supplier regarding the TLMC.



# Power Switching Devices

Product	Maximum Output	Output Firing	Phase Configurations	Agency Approvals	Page
<b>EZ-ZONE® ST</b>	75A	Zero Cross, Phase Angle	1	UL®, CSA, CE, SCCR, RoHS, W.E.E.E.	<b>327</b>
<b>DIN-A-MITE® A</b>	25A	Zero Cross	1	UL®, C-UL®, CE, SCCR, RoHS	<b>328</b>
<b>DIN-A-MITE B</b>	40A	Zero Cross	1	UL®, C-UL®, CE, SCCR, RoHS	<b>331</b>
<b>DIN-A-MITE C</b>	80A	Zero Cross, Phase Angle	1 or 3	UL®, C-UL®, CE, SCCR, RoHS	<b>334</b>
<b>DIN-A-MITE D</b>	100A	Zero Cross	1	UL®, C-UL®, CE, SCCR, RoHS	<b>340</b>
<b>POWER SERIES™</b>	250A	Zero Cross, Phase Angle	1 or 3	UL®, C-UL®, CE, SCCR	<b>343</b>
<b>QPAC</b>	1000A	Zero Cross, Phase Angle	1 or 3	UL®, C-UL®, SCCR	<b>348</b>
<b>E-SAFE® II</b>	35A	Zero Cross	1, 2 or 3	UL®, C-UL®, CE, RoHS, W.E.E.E.	<b>353</b>
<b>SERIES CZR</b>	42A	Zero Cross	1	UL®, CSA, CE, RoHS	<b>356</b>
<b>Solid State Relays (SSR)</b>	75A	Zero Cross	1	UL®, CSA, RoHS	<b>359</b>

**Note:** The specifications in the table above are best available values in each category. Not all combinations of these values are available in a single model number.



# Power Switching Devices

## Comparison Guide

Initial Cost	3 Year Cost <sup>①</sup>	Control Life	Heater Life	EMI Generation	Control	Response Rate	Options	Comments
<b>Electromechanical Relay and Contactor</b>								
Low for low current	Highest	Limited electrical and mechanical	Shortest	Yes, coil and contacts	Poor	Slowest	None	To extend life the cycle time is normally extended to 30 seconds or more.
<b>Hybrid Power Switch</b>								
Low	Medium	High	Good	Minimal	Good	Fast	None	Such as Watlow E-SAFE II and NO ARC relays.
<b>Mercury Displacement Relay (MDR)</b>								
Low for low to medium current	Medium	High	Good	Yes, coil and contact	Fair to good	Medium to fast	None	Mercury is not desirable. Minimum cycle time is two seconds. Position sensitive.
<b>Solid State Relay (SSR) Fixed Time Base</b>								
Medium	Medium	Extended	Extended	Minimal	Good	Fast	None	Excellent control with one second cycle time. Requires heatsink.
<b>Silicon Controlled Rectifier (SCR) Fixed Time Base</b>								
Medium	Low	Extended	Extended	Minimal	Good	Fast	None	Excellent control with one second cycle time.
<b>SCR Burst Firing</b>								
High	Low	Extended	Longest	Minimal	Excellent	Fastest	None	Fastest variable time base unit.
<b>SCR Phase-Angle Firing</b>								
High	Low	Extended	Longest	High	Excellent	Fastest	Current limit	Required for tungsten elements, transformers, or for current limiting.
<b>Saturable Core Reactor</b>								
Highest	Low	Extended	Longest	Minimal	Very good	Fast	Current limit	Cannot be turned full on or off, inefficient.

① Includes heater replacement and lost production.

# Power Switching Devices

## EZ-ZONE® ST

The EZ-ZONE® ST integrated solid state controller from Watlow®, offers a complete thermal system control solution in a single package. Features include a PID temperature controller connected to a high-amperage solid state relay with the option of adding a properly sized heat sink, an over- and under-temperature limit, a power shut-down contactor and digital communications in one complete and professionally engineered product.

Because the system is modular and scalable, a user only pays for what is needed. Stacking the EZ-ZONE ST integrated controller into multiple configurations enables flexibility to standardize the product platform to solve a wide range of application needs.

This integrated controller also includes 200KA short circuit current rating (SCCR) tested up to 480VAC to minimize damage in the event of a short circuit when used with required fusing.

### Features and Benefits

#### Back panel or DIN-rail mount

- Provides several mounting options

#### Compact package

- Reduces panel size

#### Touch-safe package

- Complies with IP2X increasing user safety

#### ±0.1 percent temperature accuracy

- Provides efficient and accurate temperature control

#### 200KA SCCR with proper fusing

- Minimizes damage in the event of a short circuit

#### Agency approvals: UL®, CSA, CE, RoHS, W.E.E.E.

- Meets applications requiring agency approvals

#### Three-year warranty

- Ensures Watlow's reliability and product support

#### Off-the-shelf designed system solution

- Improves system reliability and termination reduction
- Reduces installation cost
- Eliminates incompatibility headaches often encountered with using many different components and brands

#### Profile capability

- Includes ramp and soak with four files and 40 total steps

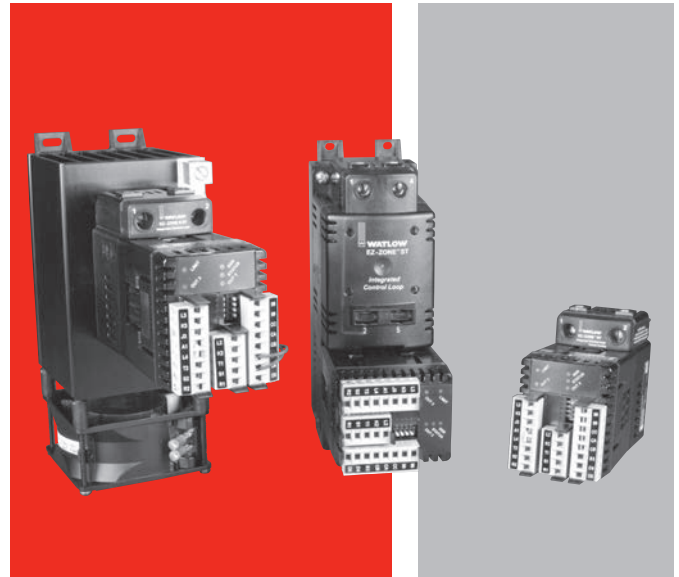

#### Ability to communicate with programmable logic controller (PLC), personal computer (PC) or operator interface terminal (OIT)

- Optional EIA-485 Modbus® RTU
- RUI/communications gateway with optional EIA-232/485 Modbus® RTU, EtherNet/IP™/TCP Modbus®, DeviceNet™ or PROFIBUS DP. Refer to page 371 for further information.

#### Solid state relay output

- Allows faster cycling, more precise control, increased heater life and improves energy efficiency
- Ability to handle up to 75 amperes
- Uses either zero-cross or phase angle control modes for flexibility to control resistive loads such as Nichrome®, tungsten or quartz lamps
- Utilizes phase angle control mode to prevent load failure or blowing fuses for tungsten or quartz loads

#### PID temperature control

- Allows single input/dual output
- Allows standard PID or adaptive TRU-TUNE+ tuning algorithms for demanding controllability requirements

#### Optional temperature limit

- Increases safety in over- and under-temperature condition

#### Optional definite purpose mechanical contactor

- Enables circuit safety shut down driven by limit control or PID alarm output signal

For detailed product and ordering information, see the full EZ-ZONE ST product section located on pages **242 through 248.**

# Power Switching Devices

## DIN-A-MITE® A

The DIN-A-MITE® A power controller provides a low-cost, highly compact and versatile solid state option for controlling electric heat. This controller is designed and manufactured with the quality features expected from Watlow. DIN-rail and panel mounting is standard on every controller. There is no need to worry about mercury, the DIN-A-MITE controller is mercury free.

Features include single-phase zero cross switching up to 25 amperes at 600VAC (see rating curve). A unique integrated design removes the guesswork associated with selecting a proper heat sink and adequate terminations for the application.

Variable time-base, 4-20mA process control and VAC/VDC input contactor versions are available. All options are model number dependent and factory configurable. This power controller also includes 200KA short circuit current rating (SCCR) tested up to 480VAC to minimize damage in the event of a short circuit when used with required fusing.



### Features and Benefits

#### 200KA SCCR with proper fusing

- Minimizes damage in the event of a short circuit

#### DIN-rail and panel mounting

- Provides versatility and quick, low-cost installation

#### Compact size

- Reduces panel space and cost

#### Touch-safe terminals

- Increases safety for installer and user

#### Mercury free

- Assures environmental safety

#### Faster switching with solid state

- Saves energy and extends heater life

#### UL® 508 listed, C-UL®, RoHS and CE with filter

- Meets applications requiring agency approval
- Reduces end product documentation

#### Back-to-back SCR design

- Ensures a rugged design

# Power Switching Devices

## DIN-A-MITE A

### Specifications

#### Operator Interface

- Control input
- Input indication LED

#### Amperage

- Single-phase, see the output rating curve
- Max.  $I^2t$  for fusing: 4000A<sup>2</sup>sec
- Latching current: 200mA min.
- Holding current: 100mA min.
- Power dissipation is 1.2 watts per ampere switched
- 200KA SCCR, Type 1 and 2 approved with the recommended fusing; see user manual

#### Line Voltage

- 24 to 660VAC model number dependent; see ordering information
- Off-state leakage: 1mA at 77°F (25°C) max.
- 50/60Hz independent

#### Control Mode, Zero Cross

- Control option C: VDC input, contactor output
- Control option K: VAC input, contactor output
- To increase service life on contactor models, the cycle time should be less than three seconds
- Control option F: 4 to 20mA DC input, variable time-base control output (3 cycles on, 3 cycles off at 50% power)

#### Control Input

- AC contactor: 24VAC  $\pm$ 10%, 120VAC +10/-25%, 240VAC +10/-25% @ 25mA max.
- DC contactor: 4.5 to 32VDC: max. current @ 4.5VDC is 8mA
- Loop powered linear current 4 to 20mA DC: loop-powered, control option F0 only (requires current source with 8.0VDC available, no more than two DIN-A-MITE inputs can be connected in series)

#### Agency Approvals

- CE with proper filter:  
204/108/EC Electromagnetic Compatibility Directive  
EN 61326-1: Industrial Immunity Class A Emissions  
2006/95/EC Low Voltage Directive  
EN 50178 Safety Requirements  
Installation category III, pollution degree 2
-  UL<sup>®</sup> 508 listed and C-UL<sup>®</sup> File E73741
- 2011/65/EU RoHS

#### Control Input Terminals

- Compression: will accept 24 to 16 AWG (0.2 to 1.5 mm<sup>2</sup>) wire

#### Line and Load Terminals

- Compression: will accept 18 to 8 AWG (0.8 to 8.4 mm<sup>2</sup>) wire

#### Operating Environment

- -4 to 176°F (-20 to 80°C); see the output rating curve chart for your application
- 0 to 90% RH (relative humidity), non-condensing
- Insulation tested to 3,000 meters
- Units are suitable for "Pollution degree 2"

#### Mounting

- Options include DIN-rail or standard back panel mounting
- DIN EN 50022, 35 mm by 7.5 mm
- Mount cooling fins vertically

#### Dimensions

- 3.7 in. (94 mm) high x 2.0 in. (50 mm) wide x 3.9 in. (98 mm) deep
- Weight: 0.71 lb (0.32kg)

Specifications are subject to change without notice.

### Output Rating Curve

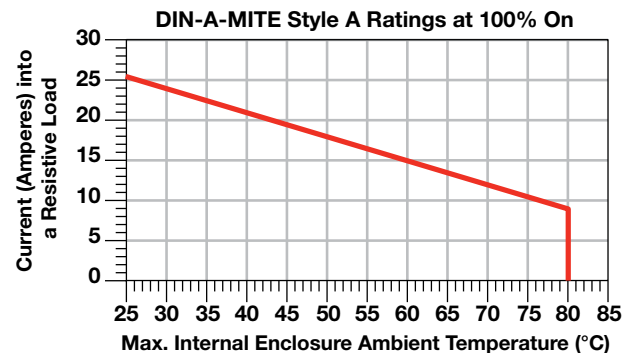

# Power Switching Devices

## DIN-A-MITE A

### Ordering Information

#### Part Number

①	②	③	④	⑤ ⑥	⑦ ⑧	⑨	⑩	⑪ ⑫
		Phase	Cooling & Current Rating	Line & Load Voltage	Control		User Manual	Custom Options
D	A	1	0	-		-	0	

③	Phase
1 =	1-phase, 1 controlled leg

④	Cooling and Current Rating (See rating curve)
0 =	Natural convection current rating 18A @ 50°C

⑤ ⑥	Line and Load Voltage
02 =	24 to 48VAC
24 =	120 to 240VAC
60 =	277 to 600VAC

⑦ ⑧	Control
C0 =	4.5 to 32VDC input, contactor output
F0 =	4 to 20mA DC input, variable time-base output
K1 =	22 to 26VAC input, contactor output
K2 =	100 to 120VAC input, contactor output
K3 =	200 to 240VAC input, contactor output

⑩	User Manual
0 =	English
1 =	German
2 =	Spanish
3 =	French

⑪ ⑫	Custom Options
00 =	Standard part
XX =	Any letter or number, custom options, labeling, etc.

### Recommended Fuses and Fuse Holders

#### Semiconductor Fuses and Holders

Part Number	Description
17-8025	25A fuse
17-5110	10-25A holder

#### DFJ Combination Fuses and Holders

Part Number	Description
0808-0325-0020	20A fuse
0808-0325-0030	30A fuse
0808-0326-1530	15-30A holder

# Power Switching Devices

## DIN-A-MITE B

The DIN-A-MITE B power controller provides a low-cost, highly compact and versatile solid state option for controlling electric heat. This controller is designed and manufactured with the quality features expected from Watlow. DIN-rail and panel mounting are standard on every control. There is no need to worry about mercury, the DIN-A-MITE controller is mercury free.

Features include single-phase and three-phase zero cross switching up to 40 and 22 amperes, respectively, at 600VAC (see rating curve). A unique, integrated design removes the guesswork associated with selecting a proper heat sink and adequate terminations for the application.

Variable time-base, 4-20mA process control and VAC/VDC input contactor versions are available. A shorted output alarm option is also available. All options are model number dependent and factory configurable. This power controller includes 200KA short circuit current rating (SCCR) tested up to 480VAC to minimize damage in the event of a short circuit when used with required fusing.



### Features and Benefits

#### 200KA SCCR with proper fusing

- Minimizes damage in the event of a short circuit

#### DIN-rail and panel mounting

- Provides versatility and quick, low-cost installation

#### Compact size

- Reduces panel space and cost

#### Touch-safe terminals

- Increases safety for installer and user

#### Single- and three-phase power

- Permits use in a variety of applications

#### Mercury free

- Assures environmental safety

#### Faster switching with solid state

- Saves energy and extends heater life

#### UL® 508 listed, C-UL®, RoHS and CE with filter

- Meets applications requiring agency approval
- Reduces end product documentation

#### Back-to-back SCR design

- Ensures a rugged design

#### Shorted output alarm (optional)

- Simplifies troubleshooting and reduces downtime

# Power Switching Devices

## DIN-A-MITE B

### Specifications

#### Operator Interface

- Control input and indication light
- Alarm output and indication light

#### Amperage Rating

- See the output rating curve
- Max. surge current for 16.6ms, 380A peak
- Max.  $I^2t$  for fusing is 4,000A<sup>2</sup>s
- Latching current: 200mA min.
- Holding current: 100mA min.
- Off-state leakage 1mA at 77°F (25°C) max.
- Power dissipation = 1.2 watts per ampere per leg switched
- 200KA SCCR, Type 1 and 2 approved with the recommended fusing; see user manual

#### Line Voltage

- 24 to 660VAC model number dependent; see ordering information

#### Control Mode, Zero Cross

- Control option C: VDC input, contactor output
- Control option K: VAC input, contactor output
- To increase service life on contactor models, the cycle time should be less than three seconds
- Control option F: 4 to 20mA DC input, variable time-base control output

#### Control Input

- AC contactor: 24VAC  $\pm$ 10%, 120VAC +10/-25%, 240VAC +10/-25% @ 25mA max. per controlled leg
- DC contactor: 4.5 to 32VDC: max. current @ 4.5VDC is 6mA per leg. Add 2mA per LED used to the total current
- Loop powered linear current 4 to 20mA DC: loop-powered, control option F0 only (requires current source with 8.0VDC available, no more than two DIN-A-MITE inputs can be connected in series)

#### Alarm

##### Shorted SCR Alarm Option

- Alarm state when the input command signal off and a 10A or more load current is detected by the current transformer (two turns required for 5A and three turns for 2.5A)

##### Alarm Output

- Energizes on alarm, non-latching
- Triac 24 to 240VAC, external supply with a current rating of 300mA @ 77°F (25°C), 200mA @ 122°F (50°C), 100mA @ 176°F (80°C) and a holding current of 200  $\mu$ A with a latching current of 5mA typical

### Agency Approvals

- CE with proper filter:  
204/108/EC Electromagnetic Compatibility Directive  
EN 61326-1: Industrial Immunity Class A Emissions  
2006/95/EC Low Voltage Directive  
EN 50178 Safety Requirements  
Installation category III, pollution degree 2
-  UL<sup>®</sup> 508 listed and C-UL<sup>®</sup> File E73741
- 2011/65/EU RoHS

### Control Input Terminals

- Compression: will accept 24 to 16 AWG (0.2 to 1.5 mm<sup>2</sup>) wire

### Line and Load Terminals

- Compression: will accept 18 to 8 AWG (0.8 to 8.4 mm<sup>2</sup>) wire

### Operating Environment

- See the output rating curve
- 0 to 90% RH (relative humidity), non-condensing
- Storage temperature: -40 to 185°F (-40 to 85°C)
- Operating temperature: -4 to 176°F (-20 to 80°C)
- Insulation tested to 3,000 meters

### DIN-rail Mount

- DIN EN 50022, 35 mm by 7.5 mm

### Back-Panel Mount

- Four mounting holes No. 6 to No. 8 (M3 to M4) fastener

### Dimensions

- 3.7 in. (94 mm) high x 3.3 in. (83 mm) wide x 4.9 in. (124 mm) deep
- Weight: 1.5 lb (0.68kg)

Specifications are subject to change without notice.

### Output Rating Curve

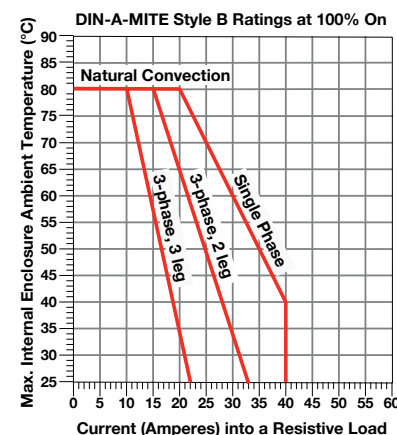

### Current Rating Table

Phase	Cooling	Current at 122°F (50°C)
1	0	35A
2, 8	0	25A
3, 9	0	17A



# Power Switching Devices

## DIN-A-MITE B

### Ordering Information

#### Part Number

①	②	③	④	⑤ ⑥	⑦ ⑧	⑨	⑩	⑪ ⑫
<b>D</b>	<b>B</b>	Phase	Cooling & Current Rating	Line & Load Voltage	Control	Alarm	User Manual	Custom Options

③	Phase
1 =	1-phase, 1 controlled leg
2 =	3-phase, 2 controlled legs
3 =	3-phase, 3 controlled legs
8 =	2 independent zones (control options C or K)
9 =	3 independent zones (control options C or K)

④	Cooling and Current Rating (See rating curve)
0 =	Natural convection

⑤ ⑥	Line and Load Voltage
02 =	24 to 48VAC
24 =	120 to 240VAC
60 =	277 to 600VAC

⑦ ⑧	Control
C0 =	4.5 to 32VDC input, contactor output
F0 =	4 to 20mA DC input, variable time-base output
K1 =	22 to 26VAC input, contactor output
K2 =	100 to 120VAC input, contactor output
K3 =	200 to 240VAC input, contactor output

⑨	Alarm
0 =	No alarm
S =	Shorted SCR alarm

⑩	User Manual
0 =	English
1 =	German
2 =	Spanish
3 =	French

⑪ ⑫	Custom Options
00 =	Standard part
XX =	Any letter or number, custom options, labeling, etc.

### Recommended DIN-rail Mount Fuses and Fuse Holders

#### Semiconductor Fuses and Holders

Part Number	Description
17-8020	20A fuse
17-8025	25A fuse
17-8030	32A fuse
17-8040	40A fuse
17-8050	50A fuse
17-5110	10-25A holder
17-5114	32-50A holder

#### DFJ Combination Fuses and Holders

Part Number	Description
0808-0325-0020	20A fuse
0808-0325-0030	30A fuse
0808-0325-0040	40A fuse
0808-0325-0050	50A fuse
0808-0326-1530	15-30A holder
0808-0326-3560	35-60A holder

# Power Switching Devices

## DIN-A-MITE C

The DIN-A-MITE C silicon controlled rectifier (SCR) power controller provides a low cost, compact and versatile solid state option for controlling electric heat. This controller is designed and manufactured with the quality features expected from Watlow. DIN-rail/panel mount and through-wall mount versions are available.

Features include single-phase, three-phase/two leg, and three-phase/three leg, 24-600VAC operation. Current switching capabilities range from 30 to 80A depending on the model ordered.

Variable time-base, linear voltage and current process control or VAC/VDC input contactor versions are available. Single-phase, phase angle firing and current limiting are also available. All options are model number dependent and factory configurable. This power controller includes 200KA short circuit current rating (SCCR) tested up to 480VAC to minimize damage in the event of a short circuit when used with required fusing.



### Features and Benefits

#### 200KA SCCR with proper fusing

- Minimizes damage in the event of a short circuit

#### DIN-rail, panel and thru-wall mounting

- Provides versatility and quick, low-cost installation

#### Compact size

- Reduces panel space and cost

#### Touch-safe terminals

- Increases safety for installer and user

#### One- and three-phase power

- Can be used in a variety of applications

#### Open heater/shorted output alarm

- Notifies the user in case of an open heater or shorted output

#### Mercury free

- Assures environmental safety

#### Faster switching with solid state

- Saves energy and extends heater life

#### UL® 508 listed, C-UL®, RoHS and CE with filter

- Meets applications requiring agency approval
- Reduces end product documentation

#### System solution component

- Provides single source thermal loop

#### Back-to-back SCR design

- Ensures a rugged design

# Power Switching Devices

## DIN-A-MITE C

### Specifications

#### Operator Interface

- Control input and indication light
- Alarm output and indication light
- Current limit indication LED

#### Amperage Rating

- See output rating curves on the next page
- Max. surge current for 16.6ms, 1,350A peak
- Max. I<sup>2</sup>t for fusing is 9100A<sup>2</sup>s
- Latching current: 200mA min.
- Holding current: 100mA min.
- Fan current: 0.14A for 24VDC; 0.12A for 120VAC; 0.06A for 240VAC
- Off-state leakage 1mA at 77°F (25°C) max.
- Power dissipation: 1 watt per ampere per leg switched
- 200KA SCCR, Type 1 and 2 approved with the recommended fusing; see user manual

#### Line Voltage

- 24 to 48VAC units: 20.4VAC min. to 53VAC max.
- 100 to 240VAC units: 48VAC min. to 265VAC max.
- 277 to 600VAC units: 85VAC min. to 660VAC max.
- 100 to 120VAC, 200 to 208VAC, 230 to 240VAC, 277VAC, 400VAC, 480VAC, 600VAC, +10/-15%, 50 to 60Hz independent ±5% (control options L, P and S)

#### Alarms (Zero Cross Models Only)

##### Shorted SCR Alarm Option

- Alarm state when the input command signal is off and a 10A or more load current is detected by the current transformer (two turns required for 5A and three turns for 2.5A)

##### Open Heater Alarm Option (Control Option S Only)

- Alarm state when the input command signal is on and the load current detected by the current transformer is 20% less than customer adjusted set point

#### Alarm Output

- Energizes on alarm, non-latching
- Triac 24 to 240VAC, external supply with a current rating of 300mA @ 77°F (25°C), 200mA @ 122°F (50°C), 100mA @ 176°F (80°C) and a holding current of 200µA with a latching current of 5mA typical

### Agency Approvals

- CE with proper filter:  
204/108/EC electromagnetic compatibility directive  
EN 61326-1: industrial immunity Class A emissions not suitable for Class B environments  
Phase angle and phase angle with current limit (control options P and L) are not CE approved for conducted or radiated emissions  
2006/95/EC low voltage directive EN 50178 safety requirements installation category III, pollution degree 2
- UL® 50 Type 4X enclosure, Class 1, Div. 2 per ANSI/ISA 12.12.01. Through-wall heat sink models T4 File 184390
- IP65
-  UL® 508 listed and C-UL® File E73741
- Shock and vibration tested to IEC 60068-2-32
- Vibration tested to IEC 60068-2-6
- 2011/65/EU RoHS

### Control Input Terminals

- Compression: will accept 24 to 16 AWG (0.2 to 1.5 mm<sup>2</sup>) wire
- Torque to 4.4 in. lb (0.5 Nm) max. with a 1/8 in. (3.5 mm) blade screwdriver

### Line and Load Terminals

- Compression: will accept 14 to 4 AWG (2 to 21 mm<sup>2</sup>) wire
- Torque to 24 in. lb (2.7 Nm) max. with a 1/4 in. (6.4 mm) blade screwdriver, or a type 1A, #2 Pozi driver

### Operating Environment

- See the output rating curve chart on next page
- 0 to 90% RH (relative humidity), non-condensing
- Storage temperature: -40 to 185°F (-40 to 85°C)
- Operating temperature: -29 to 176°F (-34 to 80°C)
- Insulation tested to 3,000 meters

### DIN-Rail Mount

- DIN EN 50022, 35 mm by 7.5 mm

### Back-Panel Mount

- Four mounting holes No. 6 to No. 8 (M3 to M4) fastener

### Through-Wall Mount

- See page 337 for through-wall panel cutout  
(**Note:** Mount cooling fins vertically.)

### Additional Specifications for Contactors and Proportional Controllers

#### Control Mode, Zero-Cross

- Control option C: VDC input, contactor output
- Control option K: VAC input, contactor output
- To increase service life on contactor models, the cycle time should be less than three seconds
- Control option F: 4 to 20mA DC input, variable time-base control output

# Power Switching Devices

## DIN-A-MITE C

### Specifications (Continued)

#### Control Input

- AC contactor: 24VAC  $\pm 10\%$ , 120VAC  $+10/-25\%$ , 240VAC  $+10/-25\%$  @ 25mA max. per controlled leg
- DC contactor: 4.5 to 32VDC: max. current @ 4.5VDC is 6mA per leg, add 2mA per LED used to the total current
- Loop powered linear current 4 to 20mA DC: loop-powered, control option F0 only (requires current source with 8.0VDC available, no more than two DIN-A-MITE inputs can be connected in series)

### Additional Specifications for Phase Angle, Phase Angle Current Limit and Single-Cycle Variable Time-Base

#### Operation

- With control option S (single-cycle, variable time-base) the output is not on for more than one consecutive AC cycle below 50% power and not off for more than one consecutive AC cycle above 50% power
- Phase angle control, single-phase only

#### Control Input

- 0 to 20mA, 4 to 20mA, 0 to 5VDC, 1 to 5VDC and 0 to 10VDC
- Input impedance 250 $\Omega$  for 4mA to 20mA, 5k $\Omega$  for linear voltage input

#### Output Voltage

- 100 to 120VAC, 200 to 208VAC, 230 to 240VAC, 277VAC, 400VAC, 480VAC and 600VAC,  $\pm 10\%$

#### Linearity (Control Option S)

- $\pm 5\%$  input to output power over 0 to 100% of span between calibration points

#### Linearity (Control Options P and L)

- $\pm 5\%$  input to output power, as referenced to a sinusoidal power curve, between calibration points

#### Resolution

- Better than 0.1% of input span with respect to output change

#### Soft Start (Control Options P and L)

Typically:

- 5 seconds soft start on power up
- Soft start on thermostat overtemperature
- Soft start on  $1/2$  cycle drop out detection
- 1 second soft start on set point change

#### Options

- Manual control kit (1k $\Omega$  potentiometer) 08-5362
- Alarm option is not available on control options P or L

Specifications are subject to change without notice.

### Output Rating Curves

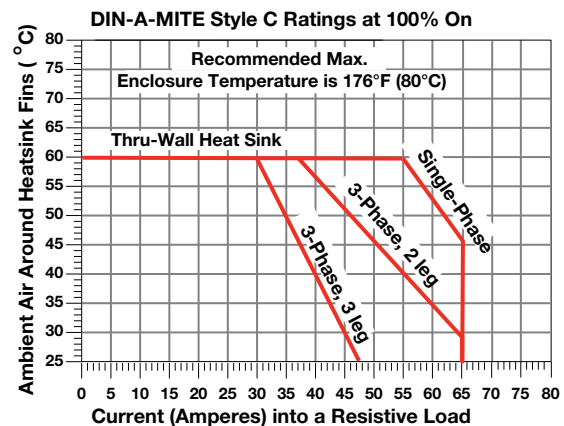
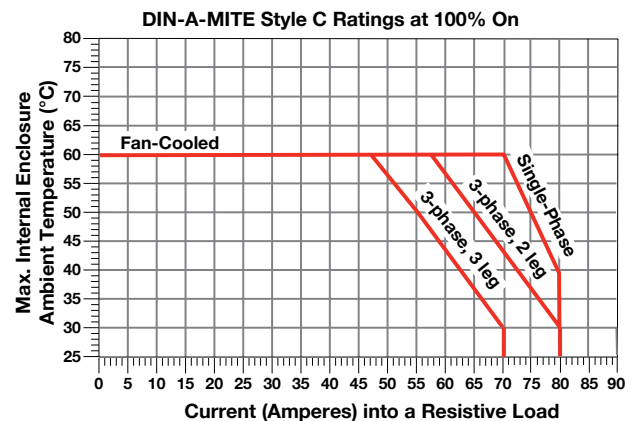
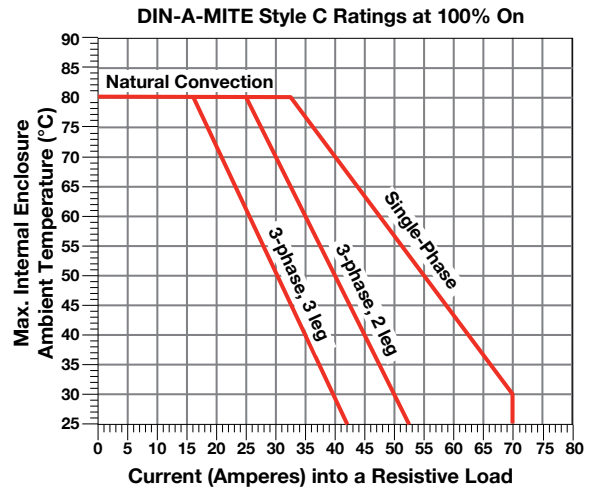

# Power Switching Devices

## DIN-A-MITE C

### Dimensions—Natural Convection, DIN-rail/Panel Mount

Front

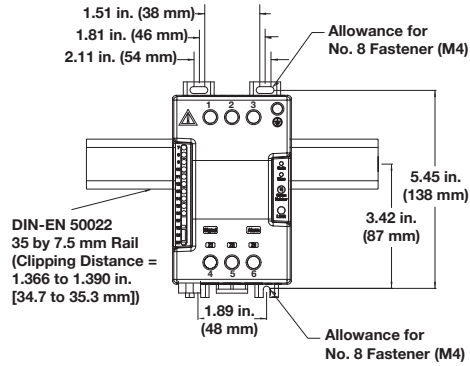

Side

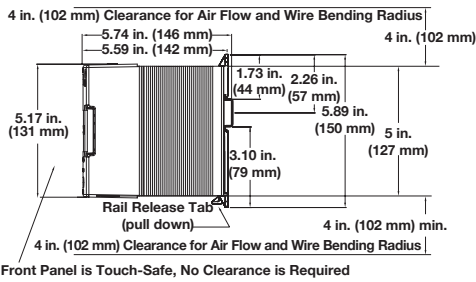

Top

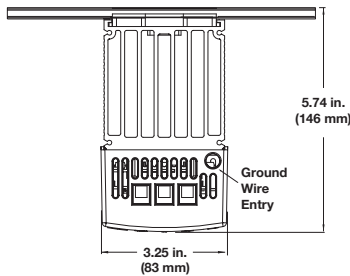

### Dimensions—Fan Cooled, DIN-rail/Panel Mount

Side

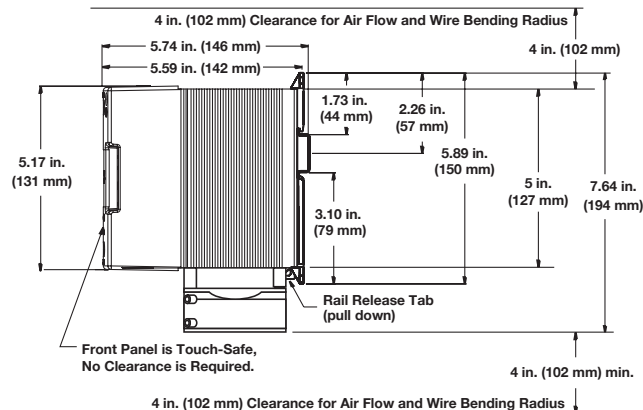

### Dimensions—Natural Convection, Through-Wall Mount<sup>①</sup>

Front

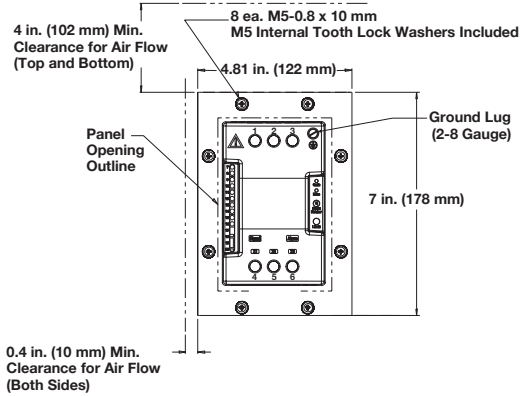

Top

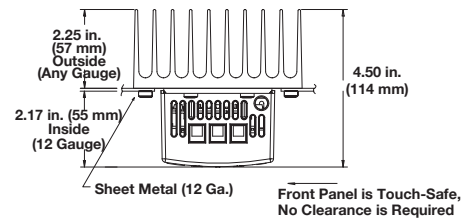

Panel Cutout

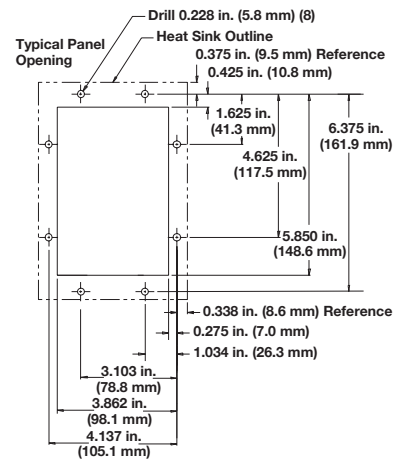

<sup>①</sup> With the potential for high through-wall heat sink temperatures, application may require a touch-safe shield.

# Power Switching Devices

## DIN-A-MITE C

### Extended Heater and Power Controller Life with Variable Time-Base

With variable time-base control, the power controller automatically adjusts the time-base and output power with respect to the command signal. Accelerated life testing shows that variable time-base control significantly reduces expansion and contraction of the heater element. This extends heater and power controller life while improving process temperature control. This saves money on heaters, downtime and maintenance.

### Loop-Powered or Transformer Powered Loop-Powered

By using a temperature controller's 4-20mA process output signal as the power supply for the DIN-A-MITE input, the cost of the power controller can be reduced. With control option F0 the 4-20mA control signal simultaneously powers the DIN-A-MITE's internal electronics and provides the input command signal.

### Transformer-Powered

DIN-A-MITE controllers with single-cycle, variable time-base or phase angle outputs (control options L, P and S) detect the power line zero cross with a transformer that also powers their internal electronics. These units can be controlled manually with a potentiometer or automatically with a temperature controller using any of the control options: 4-20mA, linear voltage (0-5,1-5 and 0-10VDC).

### Loop-Powered, Variable Time-Base Output

Models: DC\_\_ - \_\_F0 - \_\_\_\_\_

**20% Power Output: 3 AC cycles on, 12 cycles off**



**50% Power Output: 3 AC cycles on, 3 cycles off**

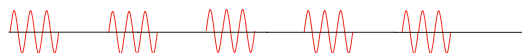

**80% Power Output: 12 AC cycles on, 3 cycles off**

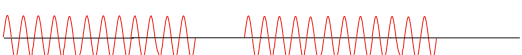

With loop-powered, variable time-base control, the minimum on or off time is three cycles.

### Phase Angle Output

Models: DC1\_ - \_\_ [L, P] - - 0\_ - \_ -

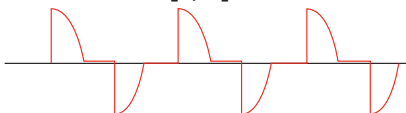

Phase angle control (control options L and P) is infinitely variable over the period of the AC sine wave. It provides a variable voltage and/or current output. The phase angle circuitry is transformer powered and accepts a linear voltage, current or potentiometer input.

### Single-Cycle, Variable Time-Base Output

Models: DC\_\_ - \_\_S\_ - \_\_\_\_\_

**25% Power Output: 1 AC cycle on, 3 cycles off**

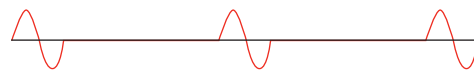

**50% Power Output: 1 AC cycle on, 1 cycle off**

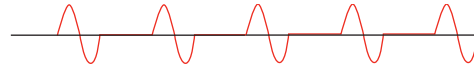

With single-cycle, variable time-base control, at 50 percent power, the output is on for one cycle and off for one cycle. At 25 percent, it is on for one cycle and off for three cycles. Under 50 percent, the output is not on for more than one consecutive cycle; over 50 percent the output is not off for more than one consecutive cycle.

### Semiconductor Fuses for Applications through 600VAC

Fuse Part Number		
Fuse Rating	Watlow	Cooper Bussman®
40A	17-8040	FWP-40A14F
50A	17-8050	FWP-50A14F
63A	17-8063	FWP-63A22F
80A	17-8080	FWP-80A22F
100A	17-8100	FWP-100A22F

Fuse Holder Part Number		
Fuse Rating	Watlow	Ferraz Shawmut
40A	17-5114	US1411
50A	17-5114	US1411
63A	17-5122	US2211
80A	17-5122	US2211
100A	17-5122	US2211

### Combined Branch Protection and Semiconductor Fuses for Applications through 480VAC

Fuse Part Number		
Fuse Rating 125% of Load	Watlow	Cooper Bussman®
20A	0808-0325-0020	DFJ-20
30A	0808-0325-0030	DFJ-30
40A	0808-0325-0040	DFJ-40
50A	0808-0325-0050	DFJ-50
63A	0808-0325-0060	DFJ-60
80A	0808-0325-0080	DFJ-80
100A	0808-0325-0100	DFJ-100

Fuse Holder Part Number		
Fuse Rating	Watlow	Cooper Bussman®
20 and 30A	0808-0326-1530	CH30J1i
40 to 63A	0808-0326-3560	CH60J1i
80 and 100A	0808-0326-7010	J601001CR

# Power Switching Devices

## DIN-A-MITE C

### Ordering Information

#### Part Number

①	②	③	④	⑤ ⑥	⑦ ⑧	⑨	⑩	⑪ ⑫
<b>D</b>	<b>C</b>	Phase	Cooling & Current Rating/Leg	Line & Load Voltage	Control	Alarm	User Manual	Custom Options

③	Phase
1 =	1-phase, 1 controlled leg
2 =	3-phase, 2 controlled legs
3 =	3-phase, 3 controlled legs (use with four wire wye)
8 =	2 independent zones (control options C, K)
9 =	3 independent zones (control options C, K)

④	Cooling and Current Rating Per Leg (See chart below)
0 =	Natural convection standard DIN-rail or panel heat sink
1 =	Fan cooled 120VAC standard DIN-rail or panel heat sink
2 =	Fan cooled 240VAC standard DIN-rail or panel heat sink
3 =	Fan cooled 24VDC standard DIN-rail or panel heat sink
T =	Natural convection through-wall or cabinet heat sink (NEMA 4X)

⑤ ⑥	Line and Load Voltage
02 =	24 to 48VAC (control options C, F, K)
12 =	100 to 120VAC (control options L, P, S)
20 =	200 to 208VAC (control options L, P, S)
24 =	100 to 240VAC (control options C, F, K); 230 to 240VAC (control options L, P, S)
27 =	277VAC (control options L, P, S)
40 =	400VAC (control options L, P, S)
48 =	480VAC (control options L, P, S)
60 =	277 to 600VAC (control options C, F, K); 600VAC (control options L, P, S)

⑦ ⑧	Control
C0 =	4.5 to 32VDC input, contactor output
F0 =	4 to 20mA DC input, variable time-base output
K1 =	22 to 26VAC input, contactor output
K2 =	100 to 120VAC input, contactor output
K3 =	200 to 240VAC input, contactor output
L (0 to 5) =	Phase angle with current limiting* (single-phase only)
P (0 to 5) =	Phase angle* (single-phase only)
S (0 to 5) =	Single-cycle variable time-base output
	0 = 4 to 20mA input
	1 = 12 to 20mA input (option S only)
	2 = 0 to 20mA input
	3 = 0 to 5VDC input
	4 = 1 to 5VDC input
	5 = 0 to 10VDC input

\* Not CE approved for conducted or radiated emissions.

⑨	Alarm
0 =	No alarm
S =	Shorted SCR alarm (not available with control options L or P)
H =	Open-heater and shorted-SCR alarm (control option S only)

⑩	User Manual
0 =	English
1 =	German
2 =	Spanish
3 =	French

⑪ ⑫	Custom Options
00 =	Standard part
1X =	1-second soft start (control options P, L)
XX =	Any letter or number, custom options, labeling, etc.

### DIN-A-MITE C Current Rating Table

Phase	Cooling	Current at 122°F (50°C)
1	0	55A
1	T	60A
1	1, 2, 3	75A
2, 8	0	40A
2, 8	T	46A
2, 8	1, 2, 3	65A
3, 9	0	30A
3, 9	T	35A
3, 9	1, 2, 3	55A

# Power Switching Devices

## DIN-A-MITE D

The DIN-A-MITE D silicon controlled rectifier (SCR) power controller provides an inexpensive, versatile product for controlling heat in an efficient package. This controller is designed and manufactured with the quality features expected from Watlow. The mounting footprint matches that of the industry standard mercury displacement relay (MDR), but there is no need to worry about mercury, the DIN-A-MITE controller is mercury free.

The DIN-A-MITE Style D is capable of zero cross switching up to 100 amperes single-phase, at 600VAC at 86°F (30°C), depending on the model selected. Combining the input of two or three controllers allows control of three-phase loads. The controller is completely touch-safe and includes on-board, front-accessible, semiconductor fuses. Options include a current transformer for load current monitoring and a shorted output alarm. The controller is UL® 508, C-UL® and CE approved making it ideal for panels and cabinets that require agency approvals.

Variable time-base, 4-20mA process control and VAC/VDC input contactor options are available. All options are model number dependent and factory configurable. This power controller also includes 200KA short circuit current rating (SCCR) tested up to 480VAC to minimize damage in the event of a short circuit when used with required fusing.



### Features and Benefits

#### 200KA SCCR with proper fusing

- Minimizes damage in the event of a short circuit

#### Standard panel mount

- Provides same mount as industry standard 100A MDR

#### Compact size

- Reduces panel space and cost

#### Touch-safe terminals

- Increases safety for installer and user

#### Mercury free

- Assures environmental safety

#### Faster switching with solid state

- Saves energy and extends heater life

#### UL® 508 listed, C-UL®, RoHS and CE with filter

- Meets applications requiring agency approval
- Reduces end product documentation

#### Back-to-back SCR design

- Ensures a rugged design

#### On-board semiconductor fusing

- Provides quick access with no extra mounting necessary



# Power Switching Devices

## DIN-A-MITE D

### Specifications

#### Amperage

- See the Output Rating Curve below
- Max. surge current for 16.6ms, 1,800A peak
- Latching current: 500mA min.
- Holding current: 200mA min.
- Power dissipation is 1.4 watts per ampere switched including on-board fusing
- 200KA SCCR, Type 1 and 2 approved with the recommended fusing; see user manual

#### Line Voltage

- 24 to 48VAC units: 20VAC min. to 53VAC max.
- 100 to 240VAC units: 48VAC min. to 265VAC max.
- 277 to 480VAC units: 85VAC min. to 528VAC max.
- 277 to 600VAC units: 85VAC min. to 660VAC max.
- 50/60Hz independent  $\pm 5\%$

#### Control Mode, Zero Cross

- Control option C: VDC input, contactor output
- Control option K: VAC input, contactor output
- To increase service life, the cycle time should be less than three seconds
- Control option F: 4 to 20mA DC input, variable time-base control output

#### Control Input

- AC contactor: 24VAC  $\pm 10\%$ , 120VAC  $+10/-25\%$ , 240VAC  $+10/-25\%$  @ 25 mA max. per controlled leg
- DC Contactor: 4.5 to 32VDC: max. current @ 4.5VDC is 8mA per leg
- Loop powered linear current 4 to 20mA DC: loop-powered, control option F0 only (requires current source with 8.0VDC available, no more than two DIN-A-MITE inputs can be connected in series)

#### Shorted SCR Alarm Option

- Alarm state when the input command signal off and a 15A or more load current is detected by the current transformer

#### Alarm Output

- Energizes on alarm, non-latching
- Triac 24 to 240VAC external supply with a current rating of 300mA @ 77°F (25°C)

#### Current Sensing

- On-board current transformer (CT), typically 0.2VAC output signal per ampere sensed into 1,000 $\Omega$  load

### Agency Approvals

- CE with proper filter:
  - 204/108/EC Electromagnetic Compatibility Directive
  - EN 61326-1: Industrial Immunity Class A Emissions
  - Not suitable for Class B emissions environment
- 2006/95/EC Low Voltage Directive
- EN 50178 Safety Requirements
-  UL<sup>®</sup> 508-listed and C-UL<sup>®</sup> File E73741
- 2011/65/EU RoHS

### Control Input Terminals

- Compression: will accept 26 to 12 AWG (0.13 to 3.3 mm<sup>2</sup>) wire

### Line and Load Terminals

- Compression: will accept 6 to 2 AWG (13.3 to 33.6 mm<sup>2</sup>) wire

### Operating Environment

- Operating temperature range: -4 to 176°F (-20 to 80°C)
- 0 to 90% RH (relative humidity), non-condensing
- Vibration: 2 g, 10Hz to 150Hz, applied in any one of three axes
- Storage temperature: -40 to 185°F (-40 to 85°C)
- Insulation tested to 3,000 meters
- Installation Category III, pollution degree 2

### Mounting

- Back-panel mounting; fits the same mounting pattern as a 100A, single-phase mercury displacement relay
- On-board semiconductor fusing

### Dimensions

- 7.3 in. (185 mm) high x 2.6 in. (66 mm) wide x 9.4 in. (239 mm) deep
- Weight: 6.5 lb (2.95kg)

Specifications are subject to change without notice.

### Output Rating Curve

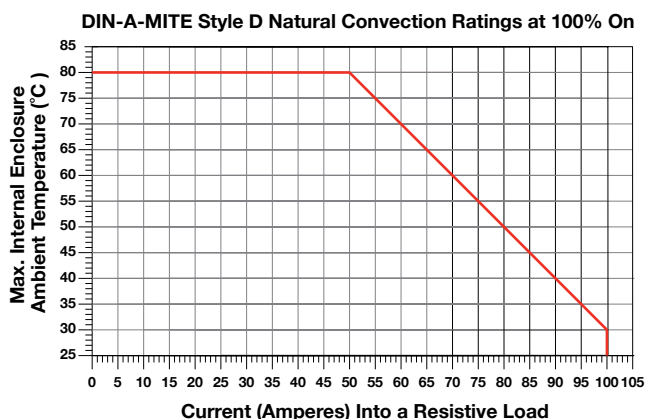

# Power Switching Devices

## DIN-A-MITE D

### Ordering Information

#### Part Number

①	②	③	④	⑤ ⑥	⑦ ⑧	⑨	⑩	⑪ ⑫
		Phase	Cooling & Current Rating	Line & Load Voltage	Control	Current Sensing or Alarm	User Manual	Custom Options
D	D	1	0	-				

③	Phase
1 =	1-phase, 1 controlled leg

④	Cooling and Current Rating (See rating curve)
0 =	Natural convection

⑤ ⑥	Line and Load Voltage
02 =	24 to 48VAC
24 =	120 to 240VAC
48 =	277 to 480VAC
60 =	277 to 600VAC

⑦ ⑧	Control
C0 =	4.5 to 32VDC input, contactor output
F0 =	4 to 20mA DC input, variable time-base output
K1 =	22 to 26VAC input, contactor output
K2 =	100 to 120VAC input, contactor output
K3 =	200 to 240VAC input, contactor output

⑨	Current Sensing or Alarm
0 =	No alarm
1 =	Load current transformer
S =	Shorted SCR alarm

⑩	User Manual
0 =	English
1 =	German
2 =	Spanish
3 =	French

⑪ ⑫	Custom Options
00 =	Standard part

### Replacement Semiconductor Fuse

Watlow Part Number	Cooper Bussmann® Part Number
0808-0096-0000	170N3437

# Power Switching Devices

## POWER SERIES™

Watlow has manufactured solid state power controllers for over forty years. Watlow's POWER SERIES™ is a microprocessor-based product that features application flexibility unmatched by any other silicon controlled rectifier (SCR) power controller on the market today. Watlow's POWER SERIES controllers include single and three-phase models from 65 to 250 amperes. Field configurable phase-angle or zero-cross firing improves application flexibility on site where needed.

50/60Hz independent operation allows utilization almost everywhere in the world without special calibration considerations. Serial communication via Modbus® RTU allows setup and monitoring of load status from a computer station or control room.

On-board semiconductor fusing improves reliability by protecting the SCRs from heater short circuits. Plus, on-board heater bakeout and control diagnostics can help eliminate initial start up problems. All these benefits are in a touch-safe package that can be quickly and easily mounted in a control cabinet.

Watlow's POWER SERIES controllers are UL® and C-UL® listed, ensuring that they meet world safety and operational standards.



### Features and Benefits

#### 200KA short circuit current rating (SCCR)

- Minimizes damage in the event of a short circuit

#### Microprocessor-based technology

- Extremely versatile and field configurable

#### Snap-fit on a pre-mounted plate

- Simplifies installation

#### Models 65 through 250 amperes rating

- Handles a wide range of loads

#### UL® 508 listed, C-UL® and CE with filter

- Meets applications requiring agency approval

#### Adjustable soft start

- Provides application flexibility

#### Heater and control diagnostics capability

- Monitors actual heater and controller performance

#### Electrically touch-safe package

- Enhances safety for installer and users

#### Serial communications with Modbus® RTU protocol

- Provides computer control and/or monitoring

#### Multizone capability

- Increases application flexibility and reduces panel space

# Power Switching Devices

## POWER SERIES

### Specifications

#### Power Bases

- Single-phase, (2 SCRs)
- 3-phase, 2-leg control, (4 SCRs)  
Resistive load only, zero-cross firing only
- 3-phase, 3-leg control, (6 SCRs)
- 3-phase, 3-leg control, (6 SCRs) for 4-wire wye loads
- Multizone, two and three single-phase zones

#### Output Control Options

- Zero-cross control, fixed time base
  - Time base one or four seconds with digital programmer
- Zero-cross control, variable time base
- Phase-angle control and phase-angle control with current limit (not for 3-phase, 2-leg models)
  - Soft start factory default four seconds upon power-up, and adjustable from 0.0 to 120 seconds
  - Soft start upon input signal change, output rate of change adjustable to limit max. rate of change from 0.1 to 100% per 0.1 second. Factory default 10%
- Current transformer included when required
- Line voltage compensated (variable time base and phase angle controllers only)
- Standby or non-operational mode

#### Output Voltage and Current Rating

- 24 to 120VAC (+10%, -15%)
- 200 to 480VAC (+10%, -15%)
- 200 to 600VAC (+10%, -15%)
- 65 through 250A per pole, model dependent; see amperage chart on the POWER SERIES spec sheet on the Watlow web site
- Min. load 1A rms ac
- Max. leakage current 5mA
- 200KA SCCR, Type 2 approved with the recommended fusing; see user manual

#### Alarms

- Single alarm relay
- Latching or non-latching
- Separate high and low values
- Alarm silencing (inhibit) on power up for alarm
- Alarm indication LEDs, shorted SCR, open heater, fuse
- Electromechanical relay, Form C contact, software configurable
  - Min. load current 10mA @ 5VDC
  - Rated resistive loads: 3A @ 250VAC or 30VDC max., inductive load rating 1.5A with a power factor  $\geq 0.4$  without contact suppression

#### Heater Bakeout

- For single-phase (phase to neutral) and 3-phase 6 SCR models only (not for 3-phase, 2-leg models)

- Soft start with over current trip, runs until programmed bakeout time expires, then goes burst or phase-angle firing. Factory default of 24 hours
- Adjustable 0 - 9999 minutes with over-current trip
- Internal current transformer included

#### Command Signal Input

##### Analog

- Input signal: field selectable and scalable, 0 to 20mA or 0 to 10VDC
- Default input signal: 4 to 20mA
- Manual control input via digital programmer/display
- Voltage input impedance 11k $\Omega$  nominal
- Current input impedance 100 $\Omega$  nominal

##### Digital

- On-board digital programmer/display and optional serial communications

##### Retransmit

- Field selectable and scalable, 0 to 20mA with 800 $\Omega$  max. load or 0 to 10VDC with 1k $\Omega$  min. load
- Default: 4 to 20mA
- Resolution:  
mA ranges =  $\pm 5\mu\text{A}$   
VDC ranges = 2.5mV nominal
- Calibration accuracy:  
mA ranges =  $\pm 20\mu\text{A}$   
VDC ranges = 10mV nominal
- Temperature stability: 100ppm/ $^{\circ}\text{C}$

#### Digital Programmer/Display and Communications Capabilities

- Programming functions
  - Adjust input and output control type, alarms and soft start, heater bakeout and current limit prompts
- Monitoring functions
  - Display input and output values along with actual output current
- Data retention of digital programmer/display upon power failure via nonvolatile memory

#### Serial Communications

- RS-232 for single drop control
- EIA-485 for single or multidrop control
  - 32 units maximum can be connected. With additional 485 repeater hardware, up to 247 units may be connected
- Isolated
- Modbus<sup>®</sup> RTU protocol
- 1200, 2400, 4800, 9600, 19200 baud rates

#### Controller Power Supply

- Universal line voltage input range 100 to 240VAC (+10%, -15%) at 55VA max.
- 50/60Hz  $\pm 5\%$  line frequency independent
- Controller line voltage for electronic power supply can be run on separate line voltage

# Power Switching Devices

## POWER SERIES

### Specifications (Continued)

#### Natural Convection and Fan Cooled Models

- Cabinet venting may be required
- See Amperage Chart with Ordering Information for available configurations

#### Power Dissipation (Watts)

- Approximately 1.25 watts/ampere per controlled leg

#### Isolation

- Command signal to load and line/load to ground 2200VAC min.
- On-board semiconductor fuses provide SCR protection

#### Mounting

- Output Amperage Rating F35: back panel
- Other Output Amperage Ratings: removable mounting plate

#### High Current Terminals

- Touch safe
- $\frac{3}{8}$  in. (10 mm) Allen head compression terminals will accept 6 AWG to 350 MCM wire. Allen wrench adapter (included) for  $\frac{3}{8}$  in. (10 mm) socket, 6 point only
- Torque to 180 in.-lbs (20.3 Nm)
- Wire strip to  $1\frac{1}{8}$  in. (30 mm)
- Requires 194°F (90°C) wire insulation rating on line and load terminals

#### Controller Terminals

- Touch safe
- $\frac{1}{8}$  in. (2.5 mm) blade screwdriver, accepts 12-22 AWG or 2 ea. 22-18 AWG wires
- Torque to 8 in.-lbs (0.9 Nm)
- Wire strip to 0.24 in. (6 mm)

#### Operating Environment

- 122°F (50°C) base rating
  - 32 to 140°F (0 to 60°C) fan cooled
  - 32 to 149°F (0 to 65°C) natural convection cooled
- 0 to 90% RH, non-condensing
- Meets EN 50178, Pollution degree three

#### Storage Temperature

- -40 to 185°F (-40 to 85°C)

#### Shipping Weight

- Output Amperage Rating F35: 38 lbs (17.2 kg)
- Other Output Amperage Ratings: 23 lbs (10.3 kg)

#### Agency Approvals

- UL® 508 listed, File #E73741, Vol. 3, Sec. 2
- C-UL® listed to C22.2 NO. 14
- CE 2004/08/EC (EN 61326-1), Class A with filter, CE 2006/95/EC (EN 50178)

### Dimensions (Output Amperage Ratings: N20, N25, N30, F20, F25 or F30)

#### Front View

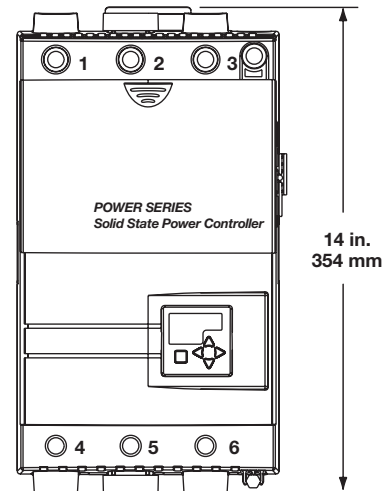

#### Top View

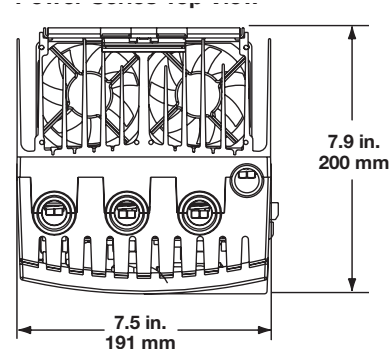

#### Mounting Plate

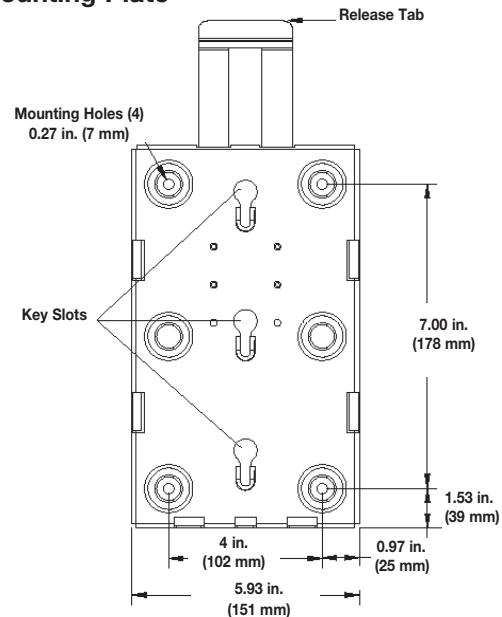

# Power Switching Devices

## POWER SERIES

### Dimensions (Output Amperage Rating: F35)

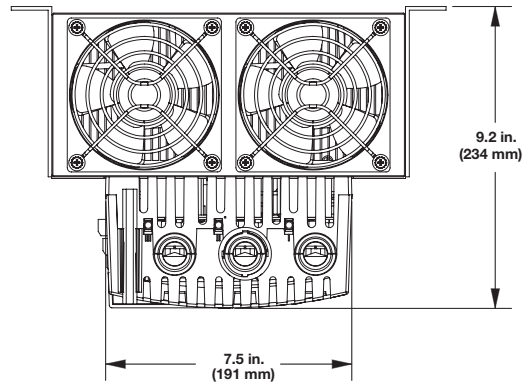

Bottom View

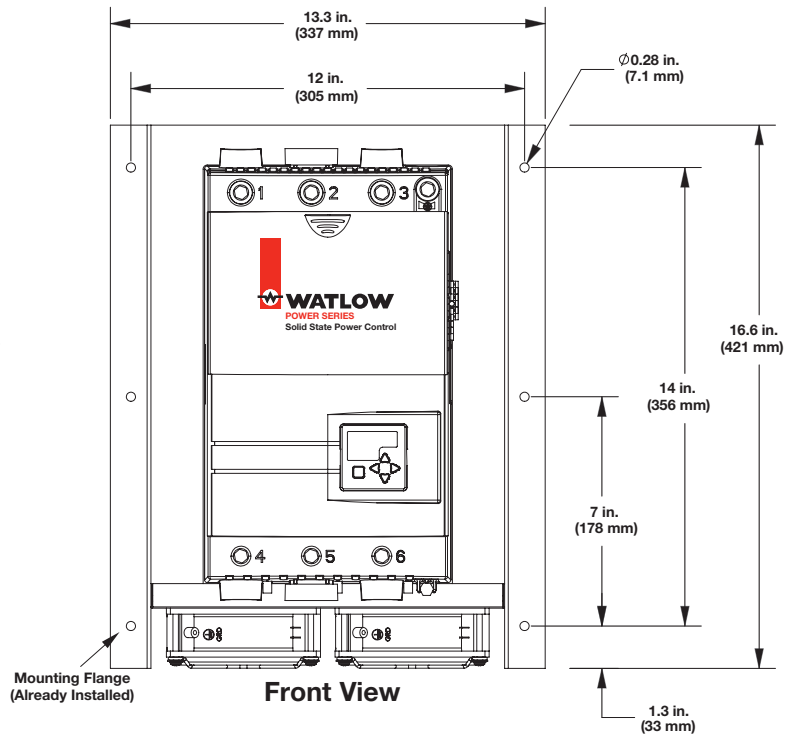

Front View

### Single-Phase Configuration

This configuration can be purchased with any or all the features available on the POWER SERIES, based on customer preference. It is intended for resistive heaters, but can also be used on transformer connected loads in the phase angle firing mode.

### Three-Phase, Two Leg Configuration

This configuration is intended for zero cross firing only into a stable resistive heater. Typically, a three-phase delta or ungrounded wye connected heater is used and only two of the three VAC line phases are switched. The third phase is a direct connection through a bussbar on board the POWER SERIES. Heater current monitoring and kVA options are available via the heater diagnostics option.

### Three-Phase, Three-Leg Configuration

All POWER SERIES options are available with this configuration. It works well with phase angle firing into a three-phase, three-wire wye or delta connected heater. In this configuration, the more common applications are transformer connected loads with heaters requiring a soft start and/or current limiting.

The three-phase, four-wire configuration is intended for zero cross firing into a three-phase grounded wye/star heater. (This is a separate hardware option, model number dependent.)

### Single-Phase, Multizone Configuration

This configuration is available in two and three single-phase zones and all the features of a single-phase unit are available. (Note that there is only one alarm relay and all zones in the controller must use the same control method.)

### Heater Diagnostics

Heater diagnostics may include some or all of the features that require heater current monitoring, depending on the model selected. Heater current monitoring is only available with heater diagnostics installed on the controller. The features dependent on heater current monitoring are heater bakeout, current limiting, heater kVA monitoring, retransmit and heater monitoring alarms such as open heater, heater out of tolerance, load balance and shorted SCR detection/error. Heater diagnostics must also be installed if you need phase angle control with current limit.

# Power Switching Devices

## POWER SERIES

### Ordering Information

#### Part Number

① ②	③	④	⑤ ⑥ ⑦	⑧	⑨	⑩	⑪ ⑫
<b>PC</b>	<b>Phase</b>	<b>Heater Diagnostics</b>	<b>Output Amperage Rating</b>	<b>Output Voltage Rating</b>	<b>Comm.</b>	<b>Feedback/Retransmit</b>	<b>Custom</b>

③	Phase
1 =	1-phase
2 =	3-phase/2-leg control, (4 SCRs), zero cross only
3 =	3-phase/3-leg control, (6 SCRs)
4 =	3-phase/4-wire, wye connected load
8 =	2 single-phase zones
9 =	3 single-phase zones

④	Heater Diagnostics
0 =	None
1 =	Heater diagnostics (required for any heater current monitoring or current limiting)

⑤ ⑥ ⑦	Output Amperage Rating
See amperage chart below	

⑧	Output Voltage Rating
A =	24 to 120V
B =	200 to 480V
C =	200 to 600V

⑨	Communications
0 =	None
1 =	EIA/TIA-232/485 communications, opto-isolated, (field selectable)

⑩	Feedback/Retransmit
0 =	None
1 =	Load current feedback (0-10V or 0-20mA scalable retransmit output) (Must have heater diagnostics selected)

⑪ ⑫	Custom
00 =	None
AA =	No Watlow logo with agency approval marks
XX =	Custom, contact your Watlow representative for options
01 =	Select for PC8 or PC9 using single-phase power supply, Watlow logo
03 =	Select for PC8 or PC9 using multi-phase power supply, Watlow logo

### POWER SERIES Features

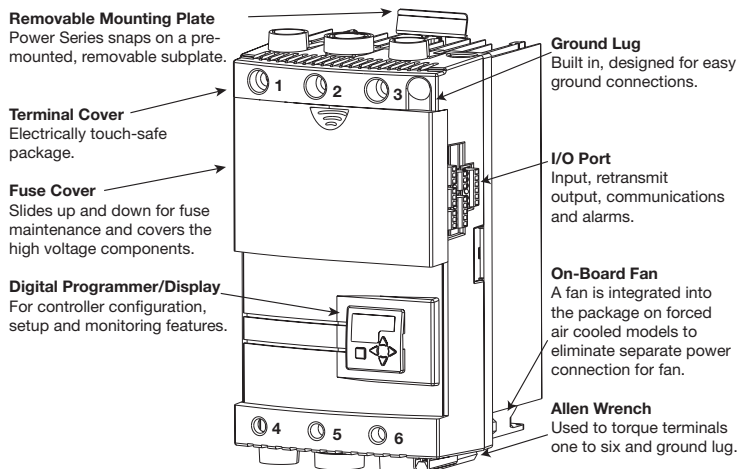

### Amperage Chart—122°F (50°C)

	Single-Phase		3-Phase, 2-Leg and 2 Single-Phase Zones		3-Phase, 3-Leg, 3 Single-Phase Zones and 4-Wire Model	
	Code	Amp	Code	Amp	Code	Amp
<b>Non Fan Cooled</b>	N20	100A	N20	80A	N20	65A
	N25	140A	N25	105A	N25	85A
	N30	165A	N30	120A	N30	105A
<b>Fan Cooled</b>	F20	125A	F20	120A	F20	90A
	F25	200A	F25	160A	F25	140A
	F30	250A	F30	185A	F30	155A
	N/A	N/A	F35	250A	F35	225A

**Note:** For current ratings at other temperatures see the rating curves in the POWER SERIES User's Manual available at [www.watlow.com](http://www.watlow.com).

### Replacement Fuses for Power Series

Watlow Part Number	Description	Bussmann Part Number
0808-0102-0100	100 amp @ 600VAC	170M1317
0808-0102-0125	125 amp @ 600VAC	170M1318
0808-0102-0160	160 amp @ 600VAC	170M1319
0808-0102-0200	200 amp @ 600VAC	170M1320
0808-0102-0250	250 amp @ 600VAC	170M1321
0808-0102-0315	315 amp @ 600VAC	170M1322

# Power Switching Devices

## QPAC

The QPAC SERIES from Watlow is a modular Silicon Controlled Rectifier (SCR) power controller with plug-in features for flexibility. Bases are rated from 150 to 1000 amperes in one-phase, three-phase, two leg and three-phase, three leg.

A variety of transformers from 120 to 575VAC along with 50/60Hz operation enable the QPAC to operate in applications anywhere. Plug-in control cards set the QPAC's SCR firing modes; solid state contactor, burst firing (zero cross) or phase-angle models are available with a wide variety of options. This power controller includes 200KA short circuit current rating (SCCR) and high speed fuses to minimize damage in the event of a short circuit.

### Features and Benefits

#### 200KA short circuit current rating (SCCR)

- Minimizes damage in the event of a short circuit

#### Modular power controller

- Unit base can be fitted with a variety of plug-in transformers and control cards

#### Available in 150 to 1000 ampere ratings

- Handles large or small loads

#### Available in solid state contactor, burst firing (zero cross) or phase-angle fired mode

- Meets most application requirements

#### Rugged design for 122°F (50°C) ambient operation

- Full rating of the power controller can be used in industrial applications

#### Semiconductor fuses and snubber protection included

- Protects the SCR from voltage or current surges or spikes

#### Open heater or shorted SCR detector option

- Diagnostic capabilities

#### UL® 508 listed and C-UL® up to 1000 amperes

- For applications requiring agency approvals

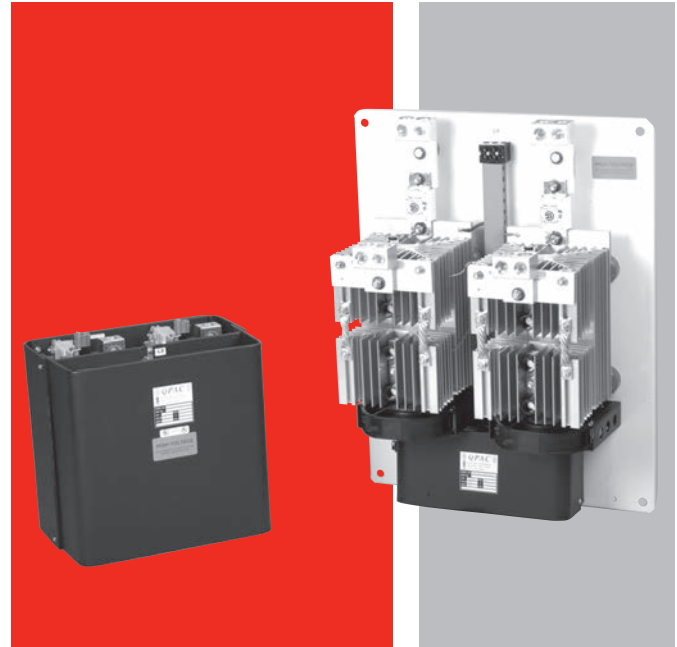

### Typical Applications

- Furnaces and ovens
- Petrochemical
- Heat treating
- Duct heating
- Environmental chambers
- Kilns



# Power Switching Devices

## QPAC

### Specifications

#### Operation

##### Modular Controller Base with Plug-In Card and Transformer

- Plug-in control cards
  - Solid state contactor, dc input
  - Burst fire control, fixed or variable time base
  - Phase-angle fire control
  - Phase-angle control with soft start and current limiting
- Plug-in transformers (50/60Hz)
- 120, 208, 240, 380, 415, 480, 575VAC operation

#### Power Bases

- 1-phase (Q01), 1 pair of SCRs
- 3-phase (Q32), 2 leg control, 2 pair SCRs
  - Resistive load only, burst firing only
- 3-phase (Q33), 3 pair hybrid SCRs/diodes
  - Recommended for phase-angle only with balanced load

#### Agency Approvals

- UL® 508 and C-UL® listed, 150 to 300A all configurations, File #E73741
- UL® 508 and C-UL® listed, 400 to 1,000A on Q01 and Q32, up to 480VAC

#### Control Card Inputs

##### (CD) Solid state contactor, dc input

- On, 4-32VDC; off, 0.5VDC
- Built-in noise reduction network

##### (BF) Burst firing control fixed time base

- Process input factory set @ 4-20mA DC
- Input impedance 250Ω (clip resistor for 5kΩ impedance voltage input), or manual control input
- Time base 4 seconds (clip resistor for 1 sec)

##### (BV) Burst firing control, variable time base

- Process input factory set @ 4-20mA DC
- Input impedance 250Ω (clip resistor for 5kΩ impedance voltage input), or manual control input.
  - Requires an accessory bias and gain card to calibrate for 0-5VDC input.

##### (AF) Phase-angle control

- Process input factory set @ 4-20mA DC
- Input impedance 250Ω (clip resistor for 5kΩ impedance voltage input), or manual control input
- Soft start approximately 6 seconds upon power-up, 1 second upon set point change

##### (AL) Phase-angle control with current limit

- Process input factory set @ 4-20mA DC
- Input impedance 250Ω (clip resistor for 5kΩ impedance voltage input), or manual control input
- Soft start approximately 10 seconds upon power-up, 1 to 2 seconds upon set point change
- Current transformer included

##### Open Heater/Shorted SCR Detector

- Zero cross/burst fire models only
- Triac output
- 24 to 240VAC, 300mA @ 77°F (25°C), 125mA @ 176°F (80°C)
- Energizes on alarm
- Holding current 200μA min.
- Latching current 5mA typical

#### Outputs

- 120 through 575VAC
- 1, 2 or 3 pole
- 150 to 1000A per pole
- SCCR, 200KA with original equipment specified semiconductor fusing

#### Line Voltage / Power

- 50/60Hz ac line frequency, Q32 and Q33 models are 50/60Hz calibration dependent
- Voltage: ±10%, 120, 208, 240, 277, 380, 415, 480, 575VAC

#### Line Voltage Compensation

- 10% Δ in line, 2% Δ in load in the 30 to 70% power region (AF, AL and BV)

#### Power Dissipation (Watts)

- 1.5 W/A per controlled leg

#### Isolation

- Command signal to load 1250VAC min.

#### Linearity

- 2%, 30 to 70% power region (All units except CD)

#### Off-State Leakage Current

- 20mA @ 480VAC

#### SCR Protection

- Semiconductor fuses provided dv/dt 200V/μsec min.
- MOV<sup>①</sup> and RC snubber network standard
- (Q32) 3rd leg fuse kit may be used, but not required, with 3-phase, 2 leg models

#### Mounting

- Heat sink fins must be mounted in vertical orientation

<sup>①</sup>MOV comes only on Q33 (3-phase, 3 leg).

# Power Switching Devices

## QPAC

### Specifications (Continued)

#### Operating Environment

- 32 to 122°F (0 to 50°C)
- 0 to 90% RH, non-condensing
- 2,000 meters altitude

#### Storage Temperature

- -40 to 185°F (-40 to 85°C)

#### Options

- Manual Control Kit for process input cards (1kΩ potentiometer) #08-5362
- 240VAC and 120VAC cooling fans

#### QPAC Weight Chart

Amps	Phase					
	1Ø/Q01		3Ø, 2-leg/Q32		3Ø, 3-wire/Q33	
	lb	(kg)	lb	(kg)	lb	(kg)
150	15	(6.8)	36	(16.3)	50	(22.7)
200	15	(6.8)	36	(16.3)	50	(22.7)
300	15	(6.8)	36	(16.3)	50	(22.7)
400-600	44	(20.0)	85	(38.5)	100	(45.4)
800-1000	49	(22.2)	120	(54.4)	135	(61.2)

### Case Styles

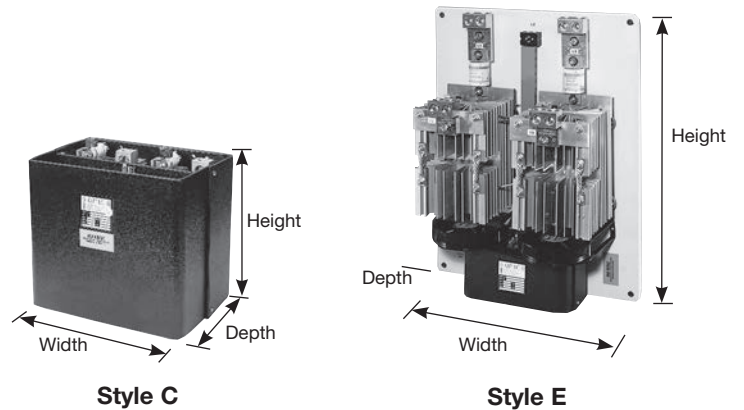

#### QPAC Dimensions

Q01				
Style	Amps	Height (H) in. (mm)	Width (W) in. (mm)	Depth (D) in. (mm)
C	150	13 (330)	6.9 (175)	10.25 (260)
C	200	13 (330)	6.9 (175)	10.25 (260)
C	300	13 (330)	6.9 (175)	10.25 (260)
E	400-600	27 (685)	17 (430)	11.7 (300)
E	800-1K	27 (685)	17 (430)	13.3 (340)

Q32				
Style	Amps	Height (H) in. (mm)	Width (W) in. (mm)	Depth (D) in. (mm)
C	150	13 (330)	13.7 (350)	10.25 (260)
C	200	13 (330)	13.7 (350)	10.25 (260)
C	300	13 (330)	13.7 (350)	10.25 (260)
E	400-600	27 (685)	21 (535)	11.7 (300)
E	800-1K	33 (840)	21 (535)	13.3 (340)

Q33				
Style	Amps	Height (H) in. (mm)	Width (W) in. (mm)	Depth (D) in. (mm)
C	150	13 (330)	20.7 (525)	10.25 (260)
C	200	13 (330)	20.7 (525)	10.25 (260)
C	300	13 (330)	20.7 (525)	10.25 (260)
E	400-600	33 (840)	27 (685)	11.7 (300)
E	800-1K	33 (840)	27 (685)	13.3 (340)

# Power Switching Devices

## QPAC

### Applications Sketch

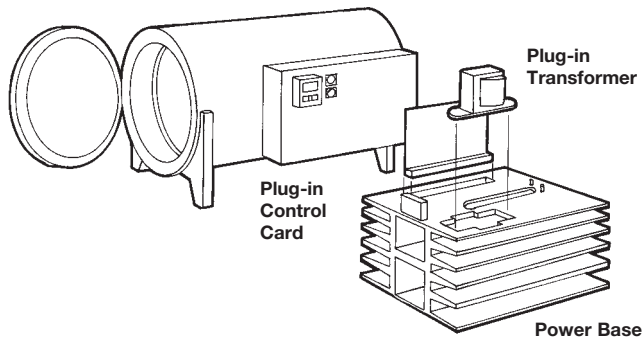

In heat treating applications, the QPAC offers modular flexibility. Different heater elements require different control firing modes, for example, tungsten elements need phase-angle firing, while Nichrome® elements use burst (zero cross) firing.

Shipping the furnace to different countries could require different voltage sources (and thus transformers): i.e., U.S. 240 or 480 volt, Australia 415 volt; Europe 380 or 400 volt. By simply changing plug-in transformers, the OEM can ship anywhere in the world.

### Wiring Example

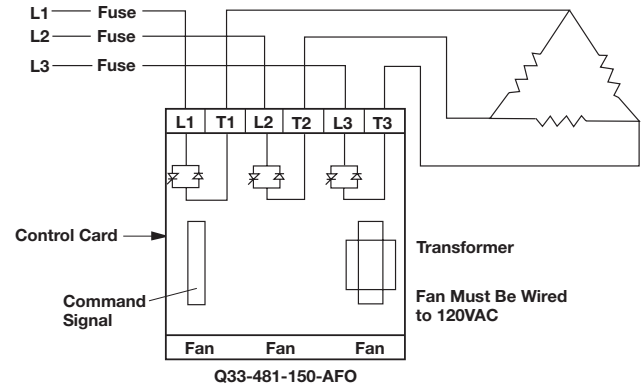

### Accessories

Manual Control Kit		08-5362
150A : 5A	Current Transformer	16-0008
200A : 5A	Current Transformer	16-0045
300A : 5A	Current Transformer	16-0073
400A : 5A	Current Transformer	0004-0286-0400
500A : 5A	Current Transformer	0004-0286-0500
600A : 5A	Current Transformer	0004-0286-0600
800A : 5A	Current Transformer	0004-0286-0800
1,000A : 5A	Current Transformer	0004-0288-1000
5A : 20mA	Interstage Transformer	16-0176

# Power Switching Devices

## QPAC

### Ordering Information

QPAC - Modular power controller; phase, burst or solid state contactor, fuse(s) and holder(s) included.

#### Part Number

①	② ③	④ ⑤	⑥	⑦ ⑧ ⑨	⑩ ⑪	⑫
Q	Phase	Operating & Output Voltage	Cooling Fan Voltage	Output Control (Amps)	Input Control Card	Open Heater/Shorted SCR Detector
Q	-	-	-	-	-	

② ③ Phase	
01=	1-phase
32=	3-phase, 2-leg (Optional 3rd leg fuse kit extra)
33=	3-phase, 3-leg

④ ⑤ Operating and Output Voltage	
12=	120VAC
20=	208VAC
24=	240VAC
27=	277VAC
38=	380VAC
41=	415VAC
48=	480VAC
57=	575VAC

⑥ Cooling Fan Voltage	
1 =	120VAC; required on all 3-phase models
2 =	240VAC; required on all 3-phase models

#### Notes:

- Customer to supply wiring and hook-up.
- All cooling fans rated at 20 W each, must be wired by customer.

⑦ ⑧ ⑨ Output Control (Amps)	
150 =	150A
200 =	200A
300 =	300A
400 =	400A
500 =	500A
600 =	600A
800 =	800A
01k =	1000A

⑩ ⑪ Input Control Card	
CD =	Solid state dc input (08-5286) contactor 4-32VDC
BF =	Burst fired, fixed time base (08-5289) 4-20mA dc
BV =	Burst fired, variable time base (08-5342) 4-20mA dc
AF =	Phase-angle fired, not available on Q32 (08-5288) 4-20mA dc
AL =	Phase-angle fired w/current limit (08-5411) 4-20mA, not available on Q32. AL option includes one current transformer. Add second CT for 3-phase, 3-leg

⑫ Open Heater/Shorted SCR Detector	
0 =	None
1 =	1-phase operation
2 =	3-phase operation

#### Notes:

- The open heater/shorted SCR detector is for burst fire operation only.
- Includes one current transformer for 1-phase and two current transformers for 3-phase.

# Power Switching Devices

## E-SAFE® II

The E-SAFE® II hybrid power switch provides reliable and accurate power switching up to 35 amperes at 158°F (70°C). This mercury-free product is specifically designed to operate in the higher ambient temperatures of foodservice applications.

Utilization of mercury relays is being eliminated due to many regulations affecting its use in the United States and around the world. The E-SAFE II is the best performing product at the most economical price. Because of the product's unique design, there is no need to purchase costly heat sinks used with traditional solid state relays (SSRs). In addition, since this is a three-phase device, there is no need to wire multiple command signals. With a switching life of millions of cycles and an ambient rating of 158°F (70°C), with no heat sink required, this product is superior to typical SSRs.

The E-SAFE II hybrid power switch provides foodservice operators with longer contact life and higher performance than typical mechanical contactors used in equipment. By using Watlow's patent NO-ARC technology, the E-SAFE II can switch millions of cycles to increase the life of the product with reduced noise and increased temperature accuracy. E-SAFE II's inherent ability to operate at fast cycle times makes it an ideal complementary product for a time, proportional, integral derivative (PID) controller.

E-SAFE II is mercury free, RoHS compliant by design, CE approved and C-UL®/UL® recognized. The reliability of the product is protected by a two-year warranty.

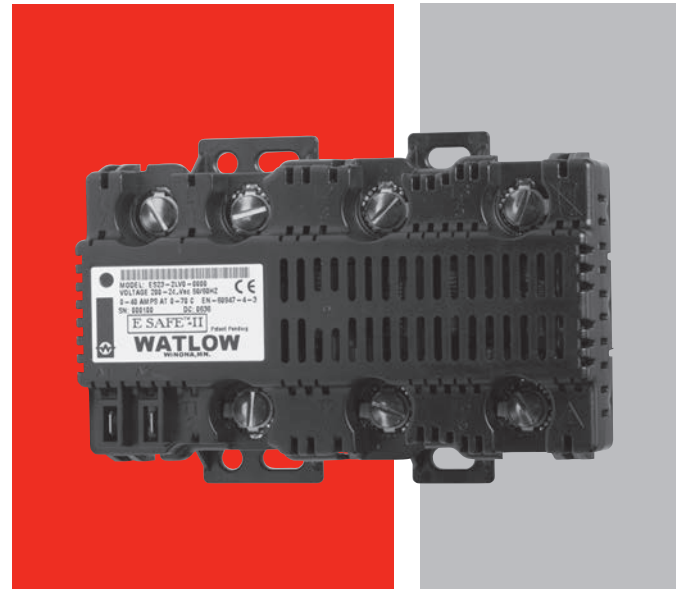

### Features and Benefits

#### Mercury free

- Improves safety by eliminating risk of toxic metals in proximity to food
- Adheres to federal and state regulations to phase out and ban mercury

#### High ambient temperature rating of 158°F (70°C)

- Specifically designed to operate in the higher ambient temperatures of foodservice applications

#### NO-ARC hybrid power switch technology

- Combines the current carrying capacity of mechanical contacts with the longevity of solid state technology
- Allows faster cycling times than mechanical contactors
- Delivers more precise temperature control, saves energy, extends heater life and decreases total cost of ownership

#### Compact and touch-safe package

- Fits in shallow foodservice cabinets
- Allows for horizontal or vertical mounting installations
- Increases safety for installer/operator
- Uses Ultem® enclosure material with a horizontal burn rating (HB) rating of 338°F (170°C) and a UL® flame retardant rating of 94 5VA

#### RoHS compliant by design

- Specifically designed to meet Asian and European requirements

#### LED indicator light

- Indicates command signal presence from controller
- Assists in troubleshooting

#### Agency approvals

- UL® recognition, C-UL® and CE
- W.E.E.E. compliant

# Power Switching Devices

## E-SAFE II

### Specifications

#### Output voltage

- 200/240VAC +10/-15%, 50/60Hz, 100/120VAC +10/-15%, 50/60Hz

#### Output amperage

- Up to 35A single, dual and three-phase

#### Operating environment

- 32 to 158°F (0 to 70°C) operating temperature
- 0 to 90% RH (relative humidity), non-condensing
- Operational life: four million switching cycles
- Installation category III, pollution degree 2

#### Control mode

- NO-ARC hybrid contactor

#### Input command signal

- 3 to 32VDC, 24VAC +20/-20%, off state  $\leq 2.7$ VDC
- 100 to 240VAC +10/-15%, (85 to 264VAC)

**Note:** On the 100 to 240VAC input models, do not use a RC snubber on the E-SAFE II relay input or the temperature control command signal output

#### LED indicator light

- Built in LED assists in troubleshooting; LED “off” indicates relay(s) are open, LED “on” indicates relay(s) are closed.

#### Input command signal terminals

- 1/4 in. fast on appliance

#### Line and load terminals

- No. 10 screw will accept ring or spade, 1/4 in. (6.35 mm) x 10-32

#### Mounting

- Back panel mount, horizontal or vertical mounting options

### Dimensional Drawings

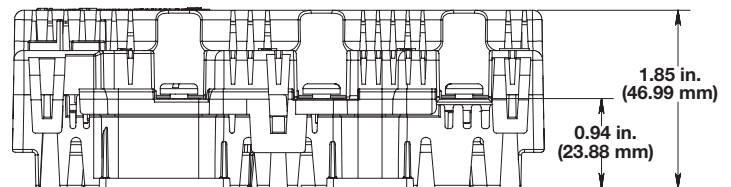
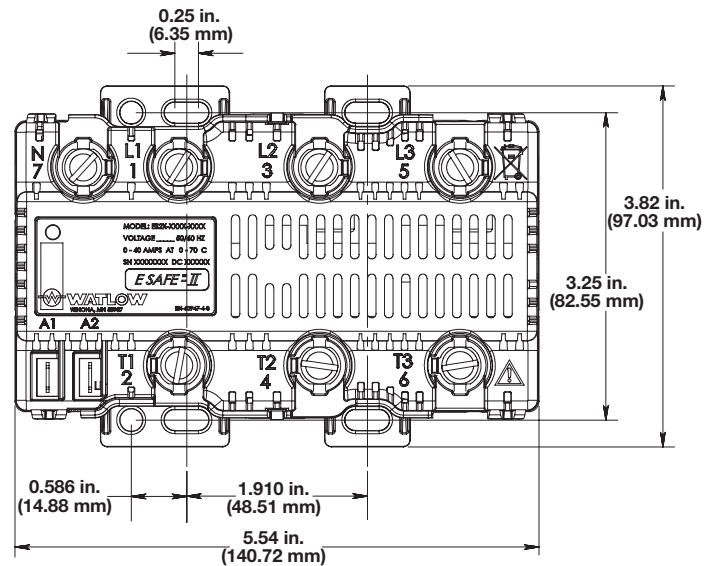

# Power Switching Devices

## E-SAFE II

### Product Rating Curve

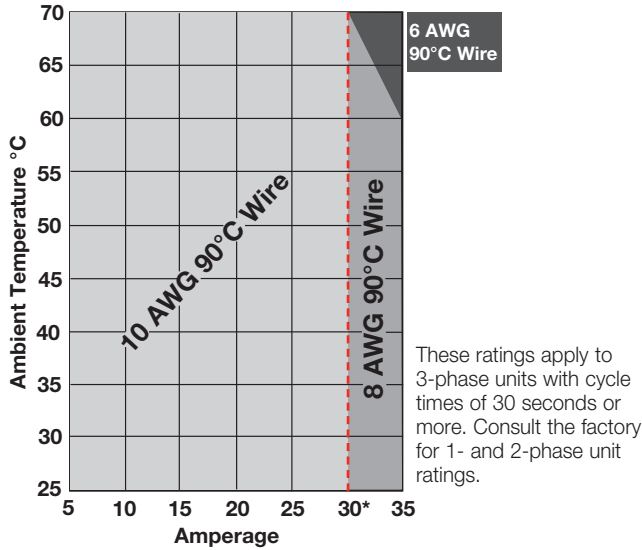

#### UL® Conditions of Acceptability

Applications must be tested as described below for specific wire insulation or specific wire gauge sizes. Tests shall be performed in the end application under worst case operating conditions.

#### Test Procedure

- Monitor temperatures of terminals, using thermocouples between the ring terminal and connectors L1, L2 or L3. The temperature must not exceed 203°F (95°C).
- Monitor temperatures of wire insulation, using a thermocouple located three inches from the connector. The temperature must not exceed the insulation rating of the wire.

\*30A is maximum rating when operating above 240VAC.

**Warning:** Thermocouples attached to terminals will be at load voltage potential, measurements need to be taken with isolated equipment or isolate the sensor from terminal with suitable insulation.

### Ordering Information

#### Part Number

① ② ③	④	⑤	⑥ ⑦	⑧	⑨	⑩ ⑪ ⑫
	Number of Poles	Load Voltage	Command Signal Voltage	Future Option	Future Option	Custom Options
ES2		-		0	- 0	

④ Number of Poles	
1 =	1 pole
2 =	2 poles controlled
3 =	3 poles controlled

⑤ Load Voltage	
1 =	100 to 120VAC
2 =	200 to 240VAC
3 =	230/277VAC (400/480VAC with wye/star, neutral connected to center required)

⑥ ⑦ Command Signal Voltage	
LV =	Low voltage 3 to 24VDC or 24VAC
HV =	High voltage 100 to 240VAC +10/-15% (85 to 264VAC)

⑩ ⑪ ⑫ Custom Options	
000 =	Standard product
Any three letters or numbers = cosmetic options	

# Power Switching Devices

## SERIES CZR

The SERIES CZR solid state relay provides a low-cost, highly-compact and versatile solid state option for controlling electric heat. With DIN-rail and back panel mounting standard on every controller, the CZR allows for simple and quick installation.

The extensive capabilities of the SERIES CZR include single-phase, 18 to 42 ampere zero-cross switching up to 600VAC (see output rating curve). Its unique integrated design removes the guesswork associated with selecting a proper heat sink and precise terminations for the application.

This controller holds many agency certifications and is ideal for applications that require UL<sup>®</sup>, CSA and CE approvals. The SERIES CZR is available in VAC/VDC input contactor versions and all configurations are model number dependent and factory selectable.

The SERIES CZR is protected by a two-year warranty.

### Features and Benefits

#### DIN-rail or standard panel mount

- Versatile, quick and low-cost installation

#### Compact size

- Reduces panel space and cost

#### Touch-safe terminals

- Increases installer and operator safety

#### Mercury free

- Environmentally safe

#### Faster switching with solid state

- Saves energy and extends heater life

#### UL<sup>®</sup> 508 recognized, CSA LR700195 certified, CE 60950 and RoHS

- Applications requiring agency approval

#### Back-to-back SCR design

- Offers rugged design for different application environments





# Power Switching Devices

## SERIES CZR

### Specifications

#### Control Mode

- Zero-cross fired contactor output

#### Operator Interface

- Command signal input
- Input signal indication LED

#### Input Command Signal

- Input Type DC1
  - Turn on voltage 4VDC max., turn off voltage 1VDC min.
  - Input current: dc typically 10mA @ 4VDC, 13mA @ 32VDC
- Input Type AC1
  - 90 to 140Vrms, must turn on at 90VAC, must turn off at 10VAC
  - Input current: 15mA typical @ 120VAC

#### Output Voltage

- 24V; 24VAC min. to 280VAC max.
- 48V; 48VAC min. to 530VAC max.
- Off state leakage: 10mA at 77°F (25°C) max. for 24 through 480VAC models
- Holding current: 250mA max.

#### Output Amperage

- See output rating curve. Ratings are into a resistive heater load.

#### Output Amperage Rating

Model	18	24	34	42
Max. Surge Current 16.6 mSec	625	250	625	1000
Max. I <sup>2</sup> t Fusing	1620	260	1620	4150

#### Agency Approvals

- Class II construction
- UL® 508 recognition, File #E73741 and CSA File LR 700195
- CE per 2006/95/EC Low Voltage Directive
- 2011/65/EU RoHS

#### Output Terminals

- Compression type
- For 18A models:
  - Max. wire size 3.0 mm (10 AWG), torque to 0.6Nm (5.3 in. lbs)
- For 24 to 42A models:
  - Max. wire size 16.0 mm (6 AWG stranded) torque to 1.5-1.7Nm (13-15 in. lbs)

#### Operating Environment

- Up to 176°F (80°C). See output rating curves for applications
- 0 to 90% RH (relative humidity), non-condensing
- Insulation tested to 3,000 meters
- Units are suitable for “pollution degree 2”
- Cycle time should be less than 3 seconds

#### Mounting

Options include DIN-rail or standard back panel mounting.

- The DIN-rail specification: DIN EN 50022, 1.38 in. x 0.30 in. (35 mm x 7.5 mm)
- Min. clipping distance: 1.37 in. (34.8 mm)
- Max. clipping distance: 1.39 in. (35.3 mm)
- Mount cooling fins vertical

#### Weight/Dimensions

- 9.2 oz (260g)
- 24 to 42A models: 3.95 in. (100 mm) high x 1.75 in. (45 mm) wide x 4.3 in. (109 mm) deep
- 18A models: 3.95 in. (100 mm) high x 0.89 in. (22.6 mm) wide x 3.9 in. (99 mm) deep

# Power Switching Devices

## SERIES CZR

### Ordering Information

#### Part Number

①	②	③ ④	⑤	⑥ ⑦	⑧	⑨ ⑩ ⑪	⑫
	Control Mode	Output Amperage		Output Voltage		Input Type (Contactor)	
C	Z		A		V		0

②	Control Mode
Z =	Zero cross

③ ④	Output Amperage
18 =	18A
24 =	24A
34 =	34A
42 =	42A

⑥ ⑦	Output Voltage
24 =	24 to 280VAC
48 =	48 to 530VAC

⑨ ⑩ ⑪	Input Type (Contactor)
DC1 =	4 to 32VDC
AC1 =	90 to 140VAC
<b>Note:</b> Do not use the AC1 input type with temperature controller outputs that include an AC snubber filter. This could cause the SERIES CZR to stay full on.	

### Output Rating Curve

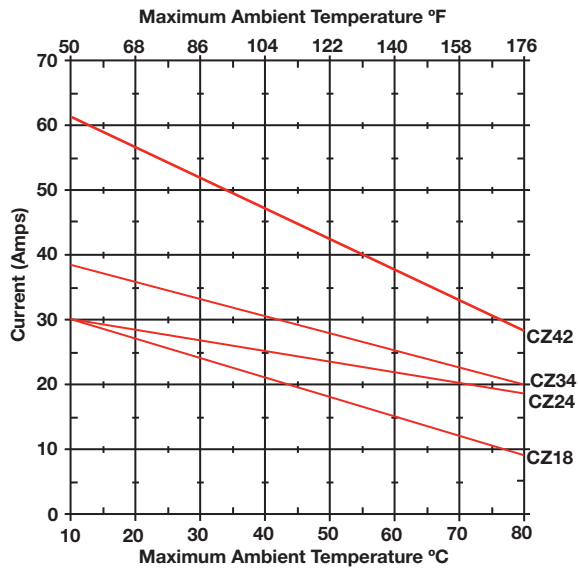

# Power Switching Devices

## Solid State Relays (SSR)

Watlow solid state relays (SSR) offer many of the advantages of solid state power controllers, yet at a lower cost. Watlow's extensive knowledge in power controller design has led to the development of a special fast cycle input card that enables a SSR to operate from a standard 4-20mA instrumentation command signal. Test results have shown that a zero cross SSR in combination with the fast cycle card promotes better temperature control and longer heater life than slow cycle relays. Through a time proportional cycle rate of one tenth of a second heater life will be extended.

Both low and high voltage models are available from 24 up to 530VAC. All ac output models include back-to-back Silicon Controlled Rectifiers (SCRs) for a more rugged design than the traditional triac based SSR. The internal design allows it to handle high currents and the harsh electrical environments of heavy industry. Watlow also offers a switched VDC model for dc heating applications.

Watlow can provide all the components necessary for trouble-free operation. This includes two standard convenience items: a thermal foil to ensure proper thermal transfer from the relay to the heat sink and Belleville washers that ensure the relay is mounted with sufficient pressure for good heat transfer. Matched semiconductor fuses and heat sinks are available to complete the power switching package.

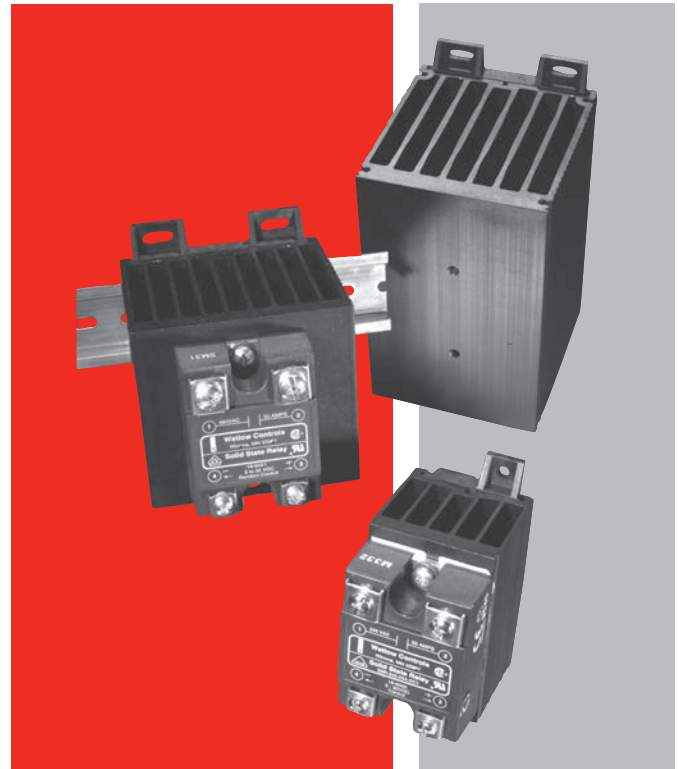

### Features and Benefits

#### Fast cycle card

- Increases heater life
- Optimizes temperature control
- Allows for higher watt density heaters

#### Zero cross firing

- Results in minimal electrical noise

#### Back-to-back SCR design

- Withstands harsh or hostile industrial environments

**UL® recognized File #E151484 and #E73741**

**CSA certified up to 600VAC, File #LR700195**

**VDE 60950 License #40021401, File #1995500**

**up to 480VAC, CE - EN 60950 and RoHS**

- Meets applications requiring agency approval

# Power Switching Devices

## Solid State Relays

### Specifications

Specifications Standard To All SSRs:	
Dielectric Strength (Volts)	4000 RMS
<b>Input, DC Control</b>	
Voltage range	3-32VDC
Typical input current	3.4 to 20mA
Turn on voltage (max.)	3VDC
Turn off voltage (min.)	1VDC
<b>Input, AC Control</b>	
Voltage range	90-280VAC
Typical input current	2mA (typical) @ 120VAC 4mA (typical) @ 240VAC
Turn on voltage (max.)	90VAC
Turn off voltage (min.)	10VAC
<b>AC Output (Max.)</b>	
Forward voltage drop	1.5VAC and 2.1VDC
Min. holding current (mA)	50mA
Turn on-off time (ms)	up to 10ms (max.)
Frequency range	47 to 63Hz

### Ambient Temperature Operating Curve

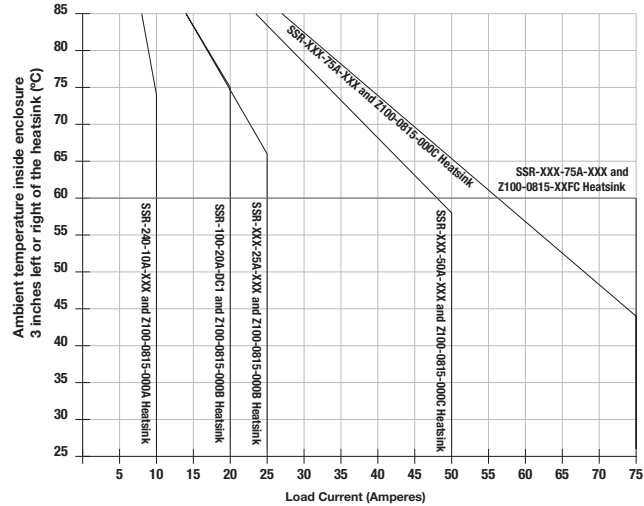

120/240VAC						
Model Number	SSR-240-10A-DC1	SSR-240-25A-DC1	SSR-240-50A-DC1	SSR-240-10A-AC1	SSR-240-25A-AC1	SSR-240-50A-AC1
Current output	10A	25A	50A	10A	25A	50A
Nominal voltage	120/240VAC	120/240VAC	120/240VAC	120/240VAC	120/240VAC	120/240VAC
One cycle surge current	120A	250A	625A	120A	250A	625A
Max. I <sup>2</sup> t for fusing	60A <sup>2</sup> seconds	260A <sup>2</sup> seconds	1,620A <sup>2</sup> seconds	60A <sup>2</sup> seconds	260A <sup>2</sup> seconds	1,620A <sup>2</sup> seconds
Thermal resistance	1.48° C/W	1.05° C/W	0.63° C/W	1.48° C/W	1.05° C/W	0.31° C/W
Ambient operating temperature	-40 to 176°F (-40 to 80°C)	-40 to 176°F (-40 to 80°C)	-40 to 176°F (-40 to 80°C)	-40 to 176°F (-40 to 80°C)	-40 to 176°F (-40 to 80°C)	-40 to 176°F (-40 to 80°C)
<b>Output (Max.)</b>						
Voltage range	48-280VAC	48-280VAC	48-280VAC	48-280VAC	48-280VAC	48-280VAC
Over voltage rating	600V (peak)	600V (peak)	600V (peak)	600V (peak)	600V (peak)	600V (peak)
Off state leakage	10mA	10mA	10mA	10mA	10mA	10mA

120/240VAC			Random Fired Models			100VDC
Model Number	SSR-240-75A-DC1	SSR-240-75A-AC1	SSR-480-50A-RND	SSR-480-75A-RND	SSR-240-10A-RND	SSR-100-20A-DC1
Current output	75A	75A	50A	75A	10A	20A
Nominal voltage	120/240VAC	120/240VAC	480VAC	480VAC	120/240VAC	100VDC
One cycle surge current	1000A	1000A	625A	1000A	120A	42A (10ms)
Max. I <sup>2</sup> t for fusing	6000A <sup>2</sup> seconds	6000A <sup>2</sup> seconds	1,620A <sup>2</sup> seconds	6000A <sup>2</sup> seconds	60A <sup>2</sup> seconds	N/A
Thermal resistance	0.31° C/W	0.31° C/W	0.63° C/W	0.31° C/W	1.48° C/W	1.06° C/W
Ambient operating temperature	-40 to 176°F (-40 to 80°C)	-40 to 176°F (-40 to 80°C)	-40 to 176°F (-40 to 80°C)	-40 to 176°F (-40 to 80°C)	-40 to 176°F (-40 to 80°C)	-4 to 176°F (-20 to 80°C)
<b>Output (Max.)</b>						
Voltage range	48-280VAC	48-280VAC	80-530VAC	80-530VAC	48-280VAC	0-100VDC
Over voltage rating	600V (peak)	600V (peak)	1200V (peak)	1200V (peak)	600V (peak)	N/A
Off state leakage	10mA	10mA	10mA	10mA	10mA	0.3mA VDC

480 VAC						
Model Number	SSR-480-25A-DC1	SSR-480-50A-DC1	SSR-480-75A-DC1	SSR-480-25A-AC1	SSR-480-50A-AC1	SSR-480-75A-AC1
Current output	25A	50A	75A	25A	50A	75A
Nominal voltage	480VAC	480VAC	480VAC	480VAC	480VAC	480VAC
One cycle surge current	250A	625A	1000A	250A	625A	1000A
Max. I <sup>2</sup> t for fusing	260A <sup>2</sup> seconds	1,620A <sup>2</sup> seconds	6,000A <sup>2</sup> seconds	260A <sup>2</sup> seconds	1,620A <sup>2</sup> seconds	6,000A <sup>2</sup> seconds
Thermal resistance	1.02° C/W	0.63° C/W	0.31° C/W	1.02° C/W	0.63° C/W	0.31° C/W
Ambient operating temperature	-40 to 176°F (-40 to 80°C)	-40 to 176°F (-40 to 80°C)	-40 to 176°F (-40 to 80°C)	-40 to 176°F (-40 to 80°C)	-40 to 176°F (-40 to 80°C)	-40 to 176°F (-40 to 80°C)
<b>Output (Max.)</b>						
Voltage range	48-530VAC	48-530VAC	48-530VAC	48-530VAC	48-530VAC	48-530VAC
Over voltage rating	1200V (peak)	1200V (peak)	1200V (peak)	1200V (peak)	1200V (peak)	1200V (peak)
Off state leakage	10mA	10mA	10mA	10mA	10mA	10mA

# Power Switching Devices

## Solid State Relays

### Heater Life

Watlow has extensively tested electric heating elements with a variety of power switching devices. Results prove that the life of an electric element dramatically increases when the on-off cycle time that is used to time-proportion the heater is kept at less than one second. This reduces the thermal expansion and contraction of the element and improves heater life as much as 20 times. This very fast cycle time controls temperature much more accurately and allows the use of higher watt density heating elements.

### Fast Cycle Card

In order to obtain the very rapid cycling time required for longer heater life, accurate temperature control and higher watt densities, Watlow has developed a loop-powered firing card for SSRs. This card operates from a standard instrumentation signal of 4 to 20mA and controls solid state relays with a time proportional cycle rate of less than one second (4VAC cycles on and 4VAC cycles off at 50 percent power).

### Thermal Transfer

A thermal foil is provided with each solid state relay for mounting on the base of the relay to improve heat transfer. In addition, two belville washers are supplied to provide the proper pressure for this transfer of heat. Use two #8-32 screws 0.625 in. (16 mm) long to secure the relay to the heat sink.

### Replacing Contactors or Mercury Displacement Relays (MDRs)

Improvements in heater life and control accuracy can be achieved with SSRs operated with rapid cycle times as compared to slower operating electromechanical relays or even MDRs. When replacing these types of relays with the SSR, it is important to consider two aspects:

#### 1. Heat

Solid state devices require a small voltage to turn on, which is consumed as heat (approx. 1.5 volts x amps = watts). This heat must be removed from the device and is usually accomplished by mounting the relay on a heat sink.

#### 2. Failure Mode

Solid state devices should last for many years when properly protected with voltage snubbers, mounted on appropriate heat sinks and when fused with semiconductor fuses against the high currents caused by electrical shorts. Watlow's SSRs include an internal voltage snubber. However, if the unit fails, the most probable condition will be a short. Mechanical relays also have a good probability of failing short. In all

cases where uncontrolled full power can cause damage, it is recommended that a high limit temperature controller and contactor be used for protection.

### Wiring Diagrams

#### Single-Phase Fast Cycle Input Card

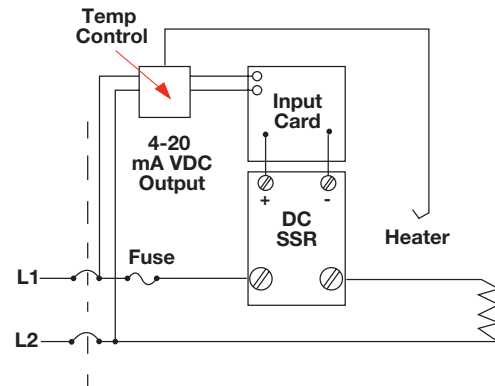

#### Shorted SSR Alarm

The most prevalent concern when using solid state relays is the possibility of a relay failing in a shorted condition. With this in mind, Watlow has designed a cost effective "Shorted SSR Alarm."

The device monitors the output (current through the heater) and activates a triac (alarm) if there is no command signal from the temperature controller. The triac can be wired to a bell, or to a normally closed latching relay to remove power to the heater.

The shorted SSR alarm is not a substitute for an agency-approved high-temperature limit device.

#### Single-Phase Shorted SSR Detector

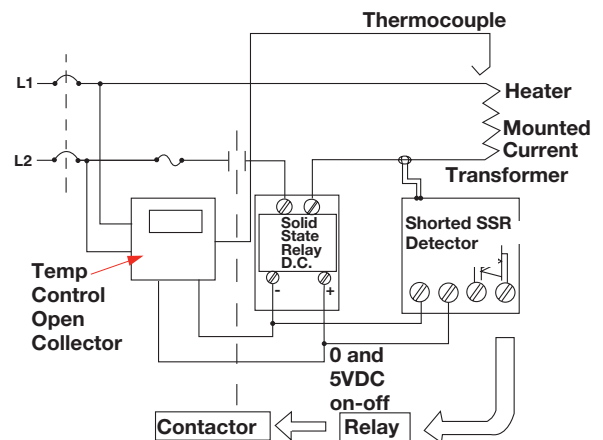

**Note:** Semiconductor power switching devices are not legal for over temperature limit or safety devices. For limit and safety devices you must have a positive mechanical break of all electrically hot legs simultaneously.

# Power Switching Devices

## Solid State Relays

### Dimensions - Heat Sink

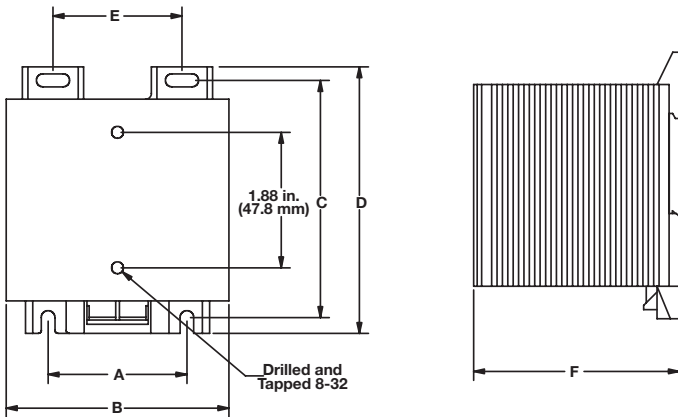

### Dimensions - Solid State Relay

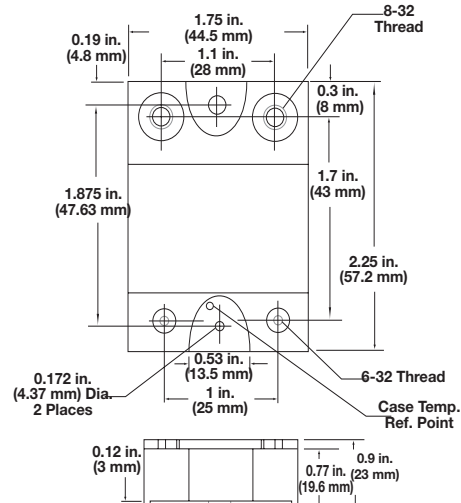

### Heat Sink Dimensions by Part Number

Part Number	Descriptor	Dimensions					
		A in. (mm)	B in. (mm)	C in. (mm)	D in. (mm)	E in. (mm)	F in. (mm)
Z100-0815-000A	18A	N/A	1.8 (46)	3.25 (82.6)	3.7 (94)	N/A	1.9 (48)
Z100-0815-000B	35A	1.91 (48.5)	3.2 (81)	3.25 (82.6)	3.7 (94)	1.81 (46)	2.9 (74)
Z100-0815-000C	55A	1.89 (48)	3.2 (81)	5.45 (138.4)	5.89 (149.6)	1.81 (46)	3.6 (91)
Z100-0815-XXFC*	75A	1.89 (48)	3.2 (81)	5.45 (138.4)	7.16 (181.9)	1.81 (46)	3.6 (91)

\*Fan cooled

## Ordering Information

### Part Number

① ② ③	④ ⑤ ⑥	⑦ ⑧	⑨	⑩ ⑪ ⑫
SSR	Voltage	Current	A	Control Voltage
-	-	-	-	-

④ ⑤ ⑥	Voltage
100 =	0 to 100VDC (20A model only)
240 =	24 to 240VAC
480 =	24 to 530VAC

⑦ ⑧	Current
10 =	10A
20 =	20A (100VDC model only)
25 =	25A
40 =	40A
50 =	50A
75 =	75A

⑩ ⑪ ⑫	Control Voltage
DC1 =	3 to 32VDC (see specifications)
AC1 =	90 to 280VAC
RND =	3 to 32VDC (10, 50 and 75A models only)
<b>Note:</b> Relay will also include thermal foil, two belville washers and #8-32 screws for mounting to a heat sink.	

Heat Sinks (sold separately)	
Z100-0815-000A =	18A or 2.2°C/watt
Z100-0815-000B =	35A or 1.1°C/watt
Z100-0815-000C =	55A or 0.6°C/watt
Z100-0815-12FC =	75A or 0.16°C/watt (120VAC fan)
Z100-0815-24FC =	75A or 0.16°C/watt (240VAC fan)

Fast Cycle Input Card and Shorted SSR Alarm Card	
For direct mounting on zero cross dc input solid state relay.	
RPC-5399-42-000 =	Fast cycle input card, 4 to 20mA input
RPC-5386-0000 =	Shorted SSR alarm card

Sub Cycle Fuses - I <sup>2</sup> T (sold separately)	
Recommended and available with holders.	

# Operator Interfaces

Product	Description	Communication Protocols	Display Height	Page
<b>Silver Series EM</b>	Rugged, email ready, touch screen operator interface terminal	Ethernet, Modbus® RTU, Modbus® TCP	4.3, 7 or 10 in. (109, 178 or 254 mm) diagonal	<b>365</b>
<b>EZ-ZONE® RUI and Gateway</b>	Remote user interface and communications device	Standard Bus, Modbus® RTU, EtherNet/IP™, Modbus® TCP, DeviceNet™ and PROFIBUS DP	Upper: 0.40 in. (10 mm) Lower: 0.24 in. (6 mm)	<b>371</b>

**Note:** The specifications in the table above are best available values in each category. Not all combinations of these values are available in a single model number.

Operator Interfaces

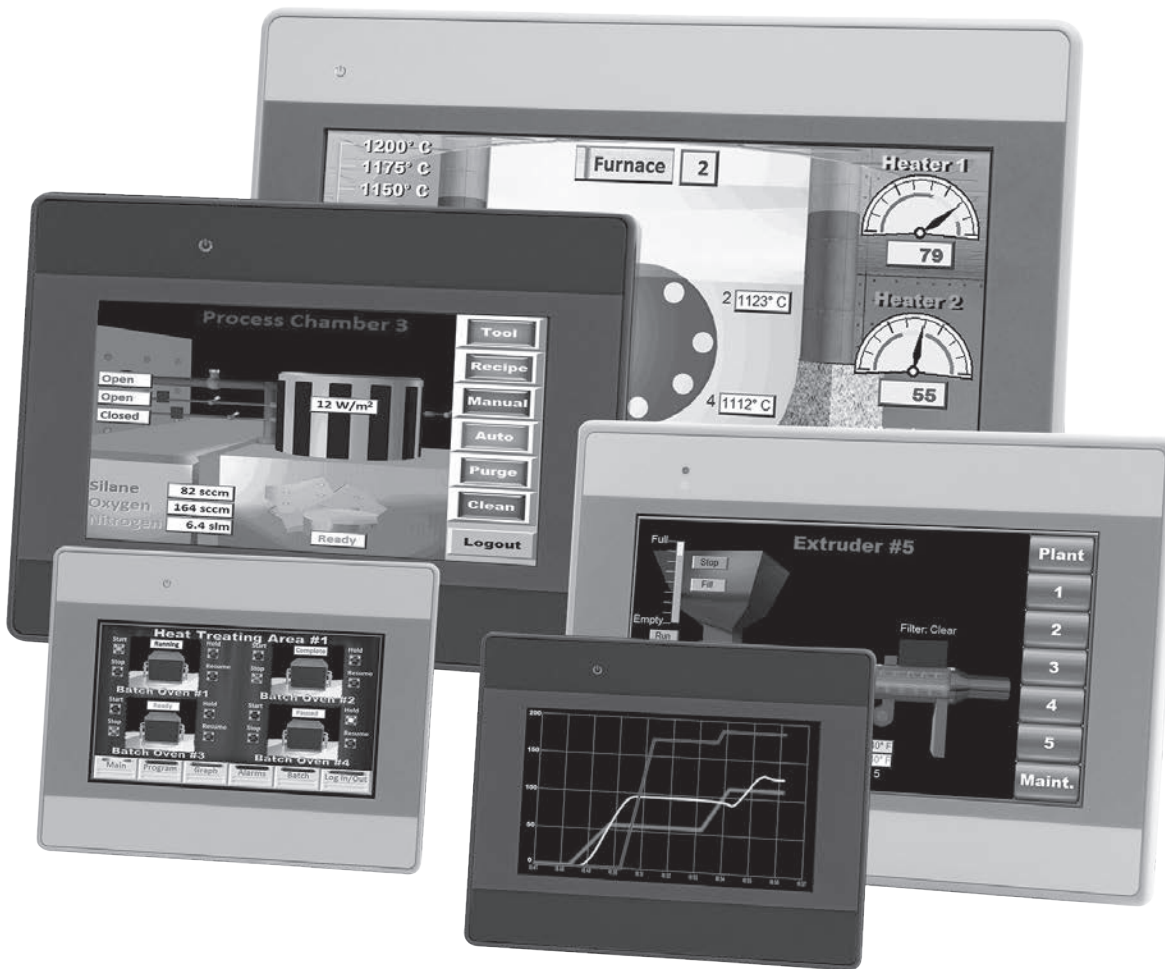





# Operator Interfaces

## Silver Series EM

The Silver Series EM is a rugged, touch-screen operator interface terminal (OIT). Available in three sizes (4.3, 7 and 10 inch diagonal display sizes), the OIT's feature serial and Ethernet communications with multiple controllers, email messaging, universal serial bus (USB host), data logging, flexible password security and multiple languages. The small bezel size and two-inch depth make mounting in tight spots easy.

The Silver Series EM programming software, EZwarePlus, is easy to use and features a large variety of built-in screen objects that makes it powerful. When creating screens, the user can call upon extensive graphics libraries, import custom graphics and add numeric displays, entry fields, analog meters, bar graphs and trend graphs with just a few mouse clicks. Screen objects are highly customizable, and the user can create libraries of their own objects for repeat use. The online simulator, Ethernet and USB support make testing and downloading fast. The EZwarePlus screen editor is part of the EZwarePlus software suite and is available as a FREE download on [www.watlow.com](http://www.watlow.com) and on the DVD-ROM found in the accessories list on page 370.

The Silver Series EM OIT paired with Watlow® controllers is the perfect solution for your industrial process or machine control application.

### Features and Benefits

#### Bright, color, high resolution, graphic, touch screen, thin film transistor (TFT) display

- Maximizes display space in the OIT footprint
- Allows application specific interface design
- Allows viewing from a distance and at an angle
- Highlights important process information with color and animation

#### User selectable portrait or landscape operation

- Fits in tight spots

#### Ethernet, serial and USB host ports

- Allows options for connecting to controllers
- Provides options for downloading projects
- Expands memory for additional recipe and data log storage
- Supports barcode readers, keyboard, mouse and printers
- Supports monitoring from a personal computer (PC) with free virtual network computing (VNC) client software



#### Support for over 100 protocols, up to three simultaneously plus multiple protocols over Ethernet

- Connects to a wide range of industrial controllers and devices
- Integrates a variety of devices to simplify complex operation tasks

#### Data logging, display and trending

- Helps operators monitor processes
- Reduces labor and increases accuracy by automating time-stamped data collection
- Stores captured data for future retrieval in multiple files
- Saves time by exporting data to Excel®-compatible comma separated value (.csv) files
- Improves process understanding by allowing live and historical data to be viewed on the OIT

#### Alarm and event email notification, monitoring and recording

- Reduces downtime by helping troubleshoot equipment and processes
- Simplifies troubleshooting by recording time and date-stamped alarm and event history
- Organizes and prioritizes alarms and events in up to 255 categories and four priority levels

#### Recipe management

- Reduces errors by automating process setting changes

#### Offline and online simulation

- Speeds up development by making it faster and easier to test projects
- Allows faster creation of fine-tuned interfaces by speeding up iterations

#### Time or trigger-based data exchange

- Simplifies integration by allowing the OIT to copy data from one controller or OIT to another

#### Internal, piezoelectric buzzer

- Provides audible alarms and key chirp

# Operator Interfaces

## Silver Series EM

### Features and Benefits (Continued)

#### Two-year warranty

- Provides product support and reliability

#### Screen object password security with programmable hierarchy and multiple users

- Prevents errors and tampering by allowing only authorized users to access restricted items on the screen
- Allows flexible hierarchies by letting the developer assign each screen object to any of 12 groups and grant each user access to any combination of groups
- Provides password protection for upload, download and access to local setup
- Supports up to 127 users

#### Screen object invisibility and/or interlock control

- Prevents errors by guiding operators

#### Powerful, easy-to-use EZwarePlus programming software

- Requires only a small investment in time to create a useful interface
- Provides the ability to learn additional features as needed
- Provides advanced interface features such as animation and pop-up windows

- Reduces development time by providing extensive graphical libraries and facilitating reuse with user-created libraries
- Simplifies development allowing import of common graphic formats: bitmaps, JPEGs and animated GIFs

#### User-programmable macros with math functions and support for floating point

- Extends functionality
- Automates processes

#### TrueType fonts with Unicode (international) characters and language switching feature

- Makes screens easy to read by allowing bold, italic, underlined, scrolling and blinking text to direct operator's eyes
- Prevents errors by communicating with users in their native languages
- Reduces development and support by allowing inclusion of up to 24 user-selectable languages in a project

#### UL®, NEMA 4, CE, RoHS,

- Allows use in harsh industrial environments
- Assures prompt product acceptance

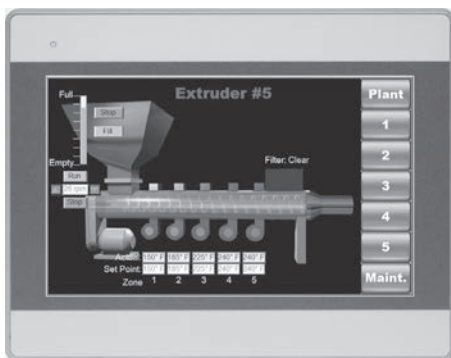

Integrate multiple devices to simplify operation of complex systems.

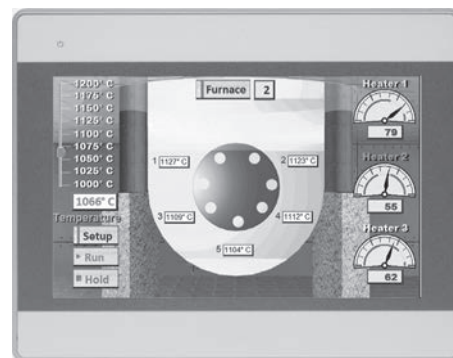

Include the types of displays users understand such as gauges, sliders and bar graphs to make screens intuitive.

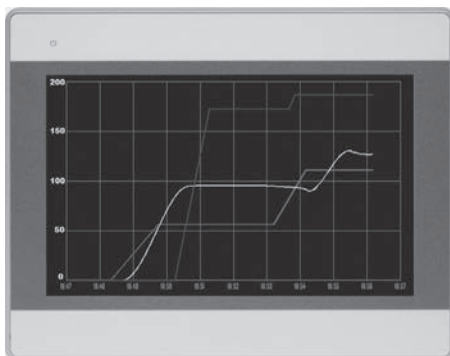

Log and graph process data for quality records and better process control.



Create screens that guide work flow.

# Operator Interfaces

## Silver Series EM

### Dimension and Connection Diagrams

Models TS00-0043-EM00/TS00-0043-EM0B

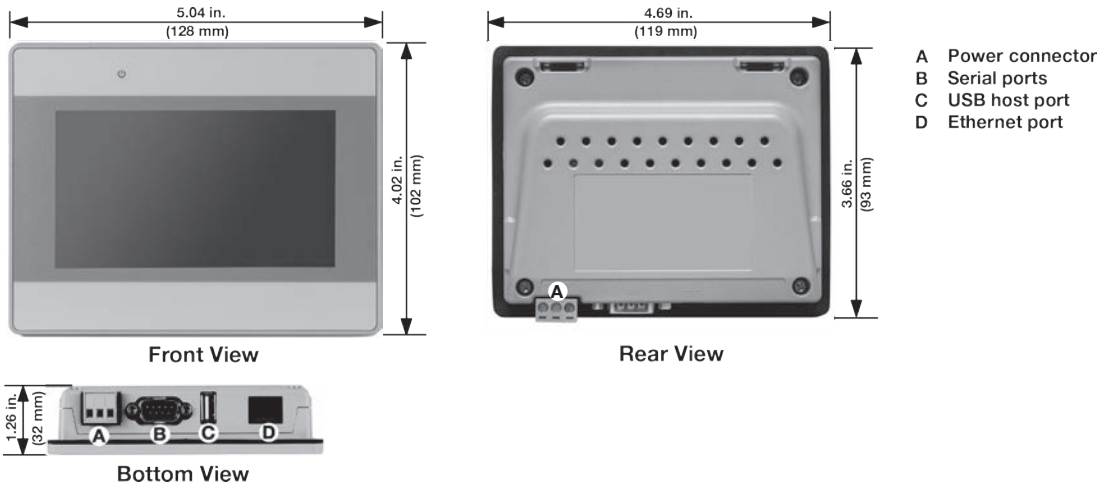

Model TS00-0070-EM00/TS00-0070-EM0B

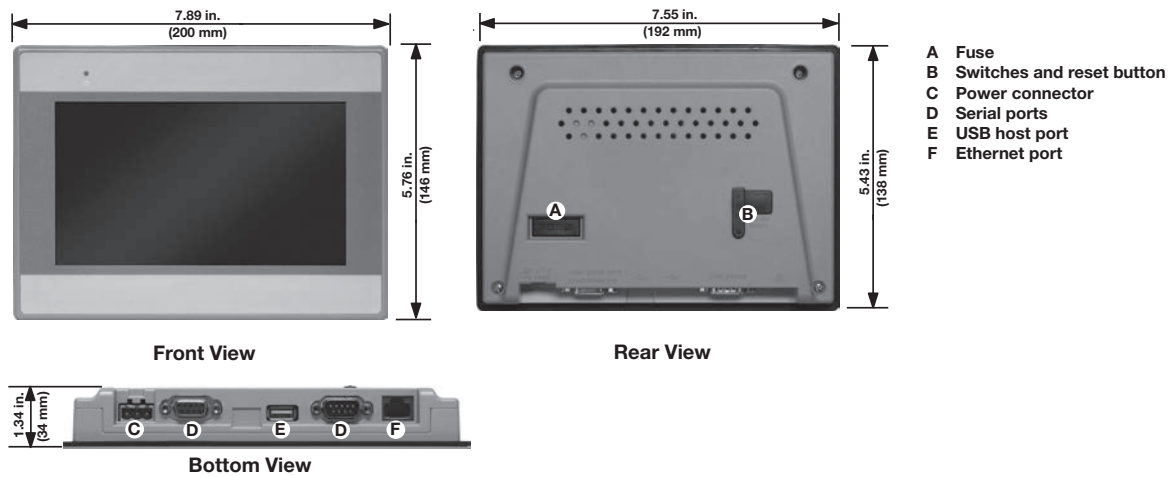

Model TS00-0100-EM00

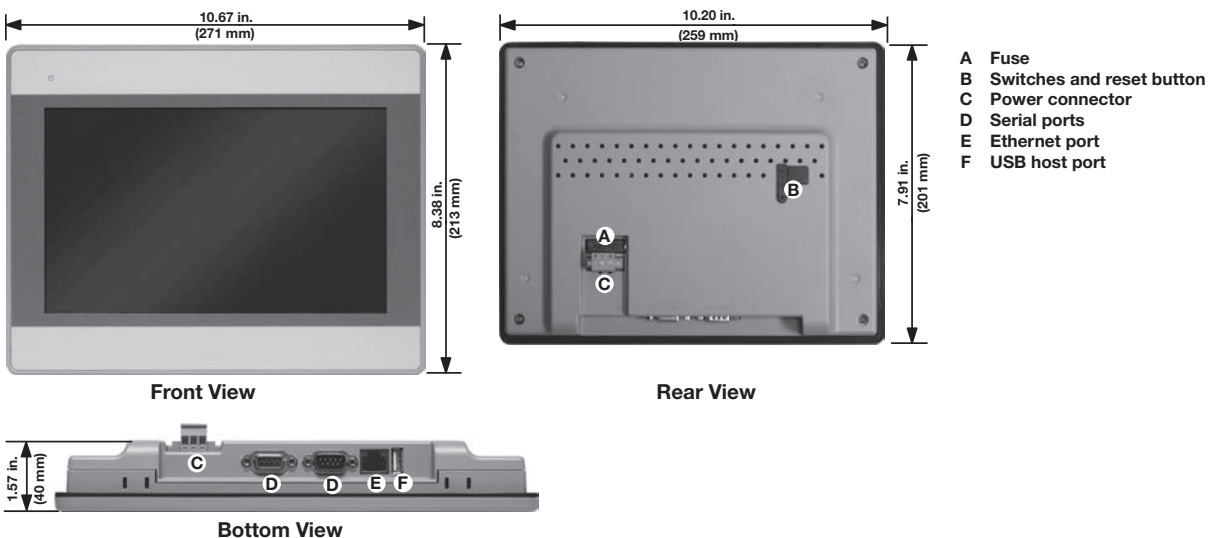

# Operator Interfaces

## Silver Series EM

Feature	Model Number		
	TS00-0043-EM00/TS00-0043-EM0B	TS00-0070-EM00/TS00-0070-EM0B	TS00-0100-EM00
Processor Type	600MHz, 32-bit, RISC, fanless		
Memory	128MB Flash, 128MB DRAM		
Ethernet Port	10/100 Base-T (RJ45)		
Serial Ports	COM1: RS-232 or RS-485 (2-wire or 4-wire) COM3: RS-485 (2-wire)		
USB Host (Type A) Version 2.0	1 each		
Real Time Clock	Built-in		
Audible Alarm and Key Chirp	Piezoelectric buzzer		
Display Type	TFT LCD		
Resolution (Pixels)	480 x 272	800 x 480	
Colors	16 million		262 thousand
LED Backlight Brightness	500 cd/m <sup>2</sup>	350 cd/m <sup>2</sup>	300 cd/m <sup>2</sup>
Contrast Ratio	500:1		
Viewing Angle	Top: 50°, bottom, right, left: 70°	Top: 60°, bottom, right, left: 70°	Top: 45°, bottom, right, left: 65°
Backlight Longevity	30,000 hours		
Touch-Screen Type	4-wire analog resistive		
Touch-Screen Resolution	Continuous		
Touch-Screen Light Transmission	Greater than 80%		
Touch-Screen Lifespan	1,000,000 activations min.		
Operating Temperature	32 to 122°F (0 to 50°C)		
Storage Temperature	-4 to 140°F (-20 to 60°C)		
Relative Humidity	10 to 90% @ 40°C (non-condensing)		
Operating Shock Resistance	10 to 25Hz (X, Y, Z direction 2G, 30 min.)		
Environmental Ratings	NEMA 4 (IP65) indoor only		
Agency	CE, cULus, RoHS	Class 1, Division 2, CE, cULus, RoHS	CE, cULus, RoHS
Enclosure	Plastic molded		
Mounting	Panel		
Dimensions Cutout (W x H)	4.69 x 3.66 in. (119 x 93 mm)	7.55 x 5.43 in. (192 x 138 mm)	10.20 x 7.91 in. (259 x 201 mm)
Dimensions Overall (W x H x D)	5.04 x 4.02 x 1.26 in. (128 x 102 x 32 mm)	7.88 x 5.76 x 1.34 in. (200 x 146 x 34 mm)	10.67 x 8.38 x 1.57 in. (271 x 213 x 40 mm)
Weight	0.55 lbs (0.25 kg)	1.31 lbs (0.6 kg)	2.9 lbs (1.3 kg)
Input Power: Voltage	24VDC		
Input Power: Current	300mA max.	350mA max.	400mA max.

## EZwarePlus Software System Requirements

### Compatible Operating Systems:

- Windows® 10, 8.1, 8, 7, Vista and XP

# Operator Interfaces

## Silver Series EM

### EZwarePlus Software Suite

The EZwarePlus software suite includes EasyConverter, EZwarePlus screen editor, Utility Manager and Recipe Editor programs.



Utility Manager uploads and downloads projects to and from the Silver Series EM OIT, opens compiled projects in simulation and launches the other EZwarePlus programs.

ID	ADDRESS	Recipe Name	Set Point 1	High Process Alarm 1	Set Point 2	High Process Alarm 2	Cor
0	0	Standard Process	450.5	500	487	528	
1	19	Spec for Alpha Lab	235	250	215	250	
2	38	Mil Specificatio	425.1	450	375	425	
3	57	FDA Test	140.3	175	150.7	180	
4	76	CE Test	50	65	75	100	

The Recipe Editor configures memory files for use with Silver Series EM OITs and allows offline creation of recipes.



EasyConverter converts log files saved by the Silver Series EM OIT to file formats used by popular Windows® software such as Microsoft® Excel®.

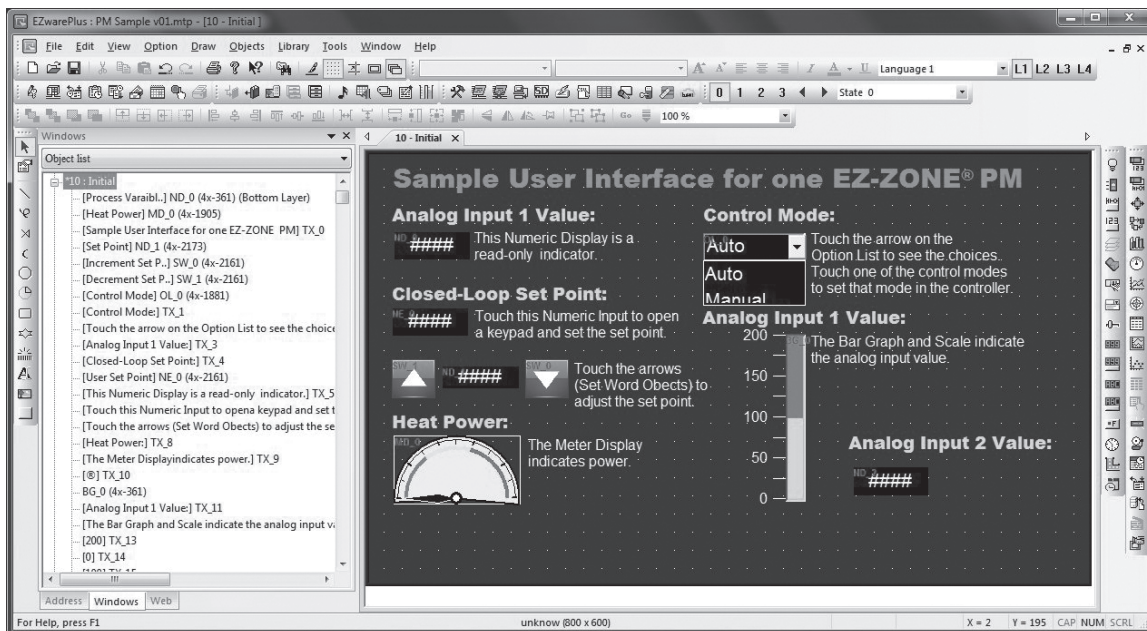

EZwarePlus provides a graphical screen designing environment with point-and-click access to features and drag-and-drop ease.

# Operator Interfaces

## Silver Series EM

### Connectivity

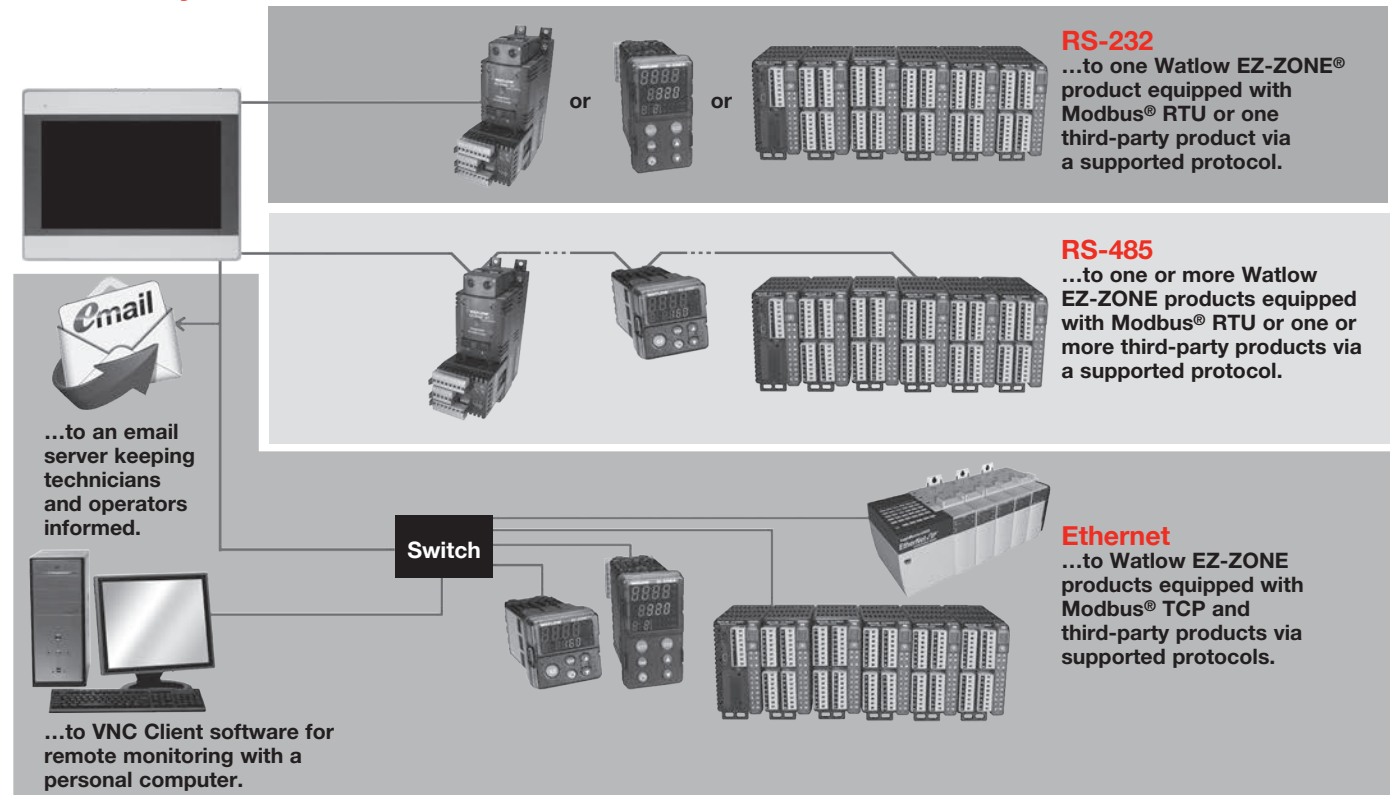

### Ordering Information

Part Number	Description
<b>TS00-0043-EM00</b>	4.3 in. (480 x 272) color TFT LCD touch screen; two-tone, light gray bezel; USB host; two serial ports and Ethernet
<b>TS00-0043-EM0B</b>	4.3 in. (480 x 272) color TFT LCD touch screen; two-tone, dark gray bezel; USB host; two serial ports and Ethernet
<b>TS00-0070-EM00</b>	7 in. (800 x 480) color TFT LCD touch screen; two-tone, light gray bezel; USB host; two serial ports and Ethernet
<b>TS00-0070-EM0B</b>	7 in. (800 x 480) color TFT LCD touch screen; two-tone, dark gray bezel; USB host; two serial ports and Ethernet
<b>TS00-0100-EM00</b>	10 in. (800 x 480) color TFT LCD touch screen; two-tone, light gray bezel; USB host; two serial ports and Ethernet

### Accessories

Part Number	Description
<b>0601-0001-0000</b>	Controller support tools DVD-ROM with programming software and product manuals
<b>0830-0750-0000</b>	Power supply, Input: 85-264VAC, Output: 24VDC, 1.7A, 40W (not Class 2)
<b>0847-0299-0000</b>	Class 2 power supply, Input: 90-264VAC, Output: 24VDC, 1.3A, 31W
<b>0219-0388-0000</b>	TS00-0043-EM00 and TS00-0043-EM0B communication cable, 5-foot, COM1 (RS-485, 2-wire) to bare wires for Watlow EZ-ZONE® controller screw terminals
<b>0219-0374-0000</b>	TS00-0070-EM00, TS00-0070-EM0B or TS00-0100-EM00 communication cable, 5-foot, COM1 (RS-485, 2-wire) to bare wires for Watlow EZ-ZONE controller screw terminals
<b>0830-0782-0000</b>	Package of 5 ea. protective screen covers for the TS00-0043-EM00 and TS00-0043-EM0B
<b>0830-0753-0000</b>	Package of 5 ea. protective screen covers for the TS00-0070-EM00 and TS00-0070-EM0B
<b>0830-0754-0000</b>	Package of 3 ea. protective screen covers for the TS00-0100-EM00

# Operator Interfaces

## EZ-ZONE® RUI and Gateway

The EZ-ZONE® Remote User Interface (RUI and communications gateway) can be utilized as a communication gateway device to save cost, space and wiring when digital communications is being used with two or more EZ-ZONE controllers. The EZ-ZONE RUI can also serve as a display for showing all parameter values for up to 16 EZ-ZONE controllers, again saving cost, space and wiring expenses.

### Indicator Features and Benefits—Remote User Interface (RUI)

#### Single user interface device or location to access multiple controllers

- Easy accessibility to all controllers and all parameters from a central location by using one RUI display
- Reduces component material costs by using a single RUI to display multiple control zones
- Eliminates cost and complexity from bringing all controller related input and output wiring to the front panel

#### Flexible use of a display interface

- Can be used when needed during normal machine production, for OEM prototype design purposes or for remote troubleshooting scenarios
- Ability to use more than one RUI indicator to display additional data including temperature and current (ammeter) to improve user system interface

### Communications Gateway Features and Benefits

#### A single RUI and gateway provides field bus access for up to 16 EZ-ZONE controllers

- Lowers solution cost when field bus communications is required for multiple loops

#### Expand communication protocols to all EZ-ZONE controllers

- Ability to utilize multiple communication protocols for different user preferences. Flex between different communication protocols while still maintaining a reduced level of inventory

#### Delivers multiple communication protocol options

- Ability to connect EZ-ZONE controllers to communication networks utilizing
  - Modbus® RTU
  - DeviceNet™
  - Ethernet/IP™
  - Modbus® TCP
  - PROFIBUS DP



### Additional Features

#### EZ-ZONE P3T armor sealing system

- Complies with NEMA 4X, IP65 RUI
- Offers water and dust resistance, can be cleaned and washed down

#### EZ-KEY (RUI)

- Programmable EZ-Key is a functional key programmable by the user to perform simple one-touch operation of repetitive user activities

#### Compact package

- Reduces required panel size for 1/16 DIN
- Utilizes less depth behind panel allowing for mounting in tight spaces

#### Touch-safe package

- Complies with IP2X which increases safety for user

#### Agency approvals: UL® Listed, CSA, CE, RoHS, W.E.E.E., SEMI F47-0200, Class 1, Div. 2 rating on selected models

- Meets applications requiring agency approvals

#### Three-year warranty

- Provides product support and protection

# Operator Interfaces

## EZ-ZONE RUI and Gateway

### Specifications

#### Line Voltage/Power

- Universal high voltage 100 to 240VAC, +10%/-15%; (85-264VAC), 50/60Hz, ±5%
- Low voltage 20 to 28VAC or 25 to 40VDC, 50/60Hz, ±5% for RUI only in short case version
- Low voltage 20 to 28VAC or 12 to 40VDC, 50/60Hz, ±5% for RUI and Gateway in long case version
- Data retention upon failure via nonvolatile memory

#### Environment

- 0 to 149°F (-18 to 70°C) operating temperature
- -40 to 185°F (-40 to 85°C) storage temperature
- 0 to 90% RH, non-condensing

#### Wiring Termination—Touch-Safe Terminals

- Terminals touch safe, removable, 12 to 22 AWG

#### DIN Sizes

- 1/6 DIN

#### Display Update Rate

- 1HZ

#### Operator Interface

- Dual 4 digit, 7 segment LED displays
- Forward, backward, up and down keys plus a customer-programmable function key - EZ key

#### Communication Options

- Standard bus - ships with all EZ-ZONE products
- EIA-235/485, Modbus® RTU
- EtherNet/IP™, Modbus® TCP, 10 BASE-T/100 BASE-TX
- DeviceNet™
- PROFIBUS DP

#### Agency Approvals

- cULus® UL®/EN/CSA C22.2 No. 61010-1 listed, File E185611 for long case models
- cULus® UL®508/EN/CSA C22.2 No. 61010-1 listed, File E102269 for short case models
- CSA C22.2 No. 14 (short case) No. 24 (long case), File 158031
- UL® 50 4X indoor locations, NEMA 4X, IP65 front seal
- cULus® ANSI/ISA 12.12.01-2007, CSA-C22.2 No. 213-1987, Class 1, Div. 2, Groups A, B, C and D, temperature code T4A, File E184390 (optional)
- CE, RoHS by design, W.E.E.E.
- SEMI F47-0200 when powered at 24V or greater

## RUI (EZKB) Utilized as a Communication Gateway Device

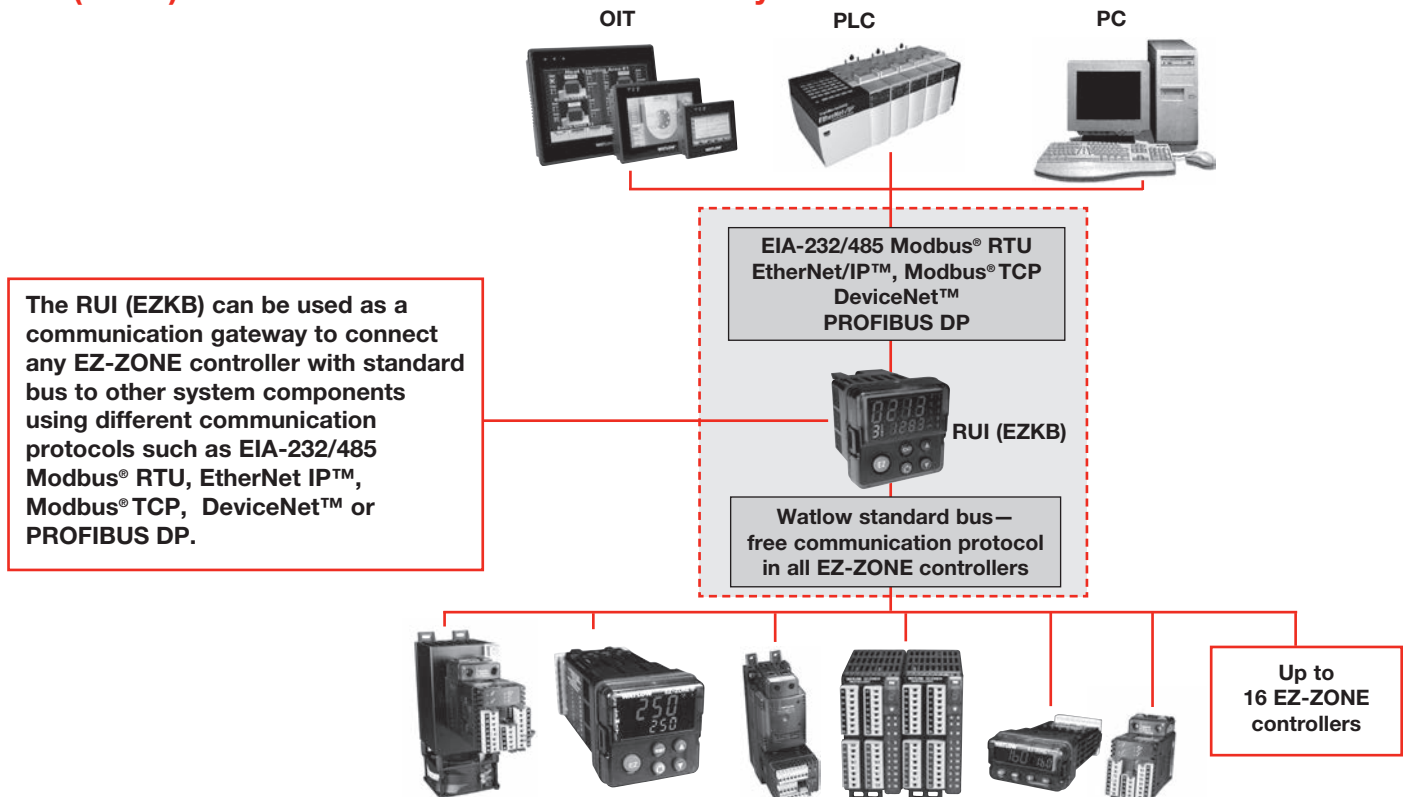



# Operator Interfaces

## EZ-ZONE RUI and Gateway

### Remote User Interface (RUI)— Dimensional Drawings

Front View

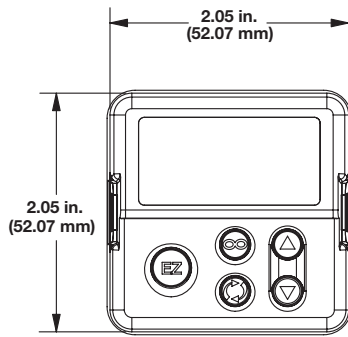

Short Case Version

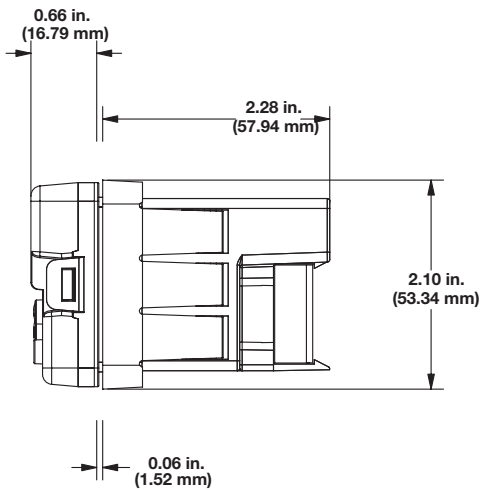

Long Case Version

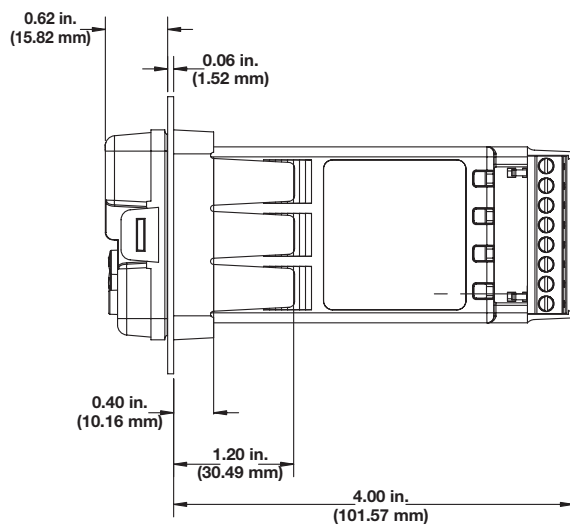

### Accessory—DIN-Rail Mounting Bracket

Part Number: 0822-0586-P002

Front View

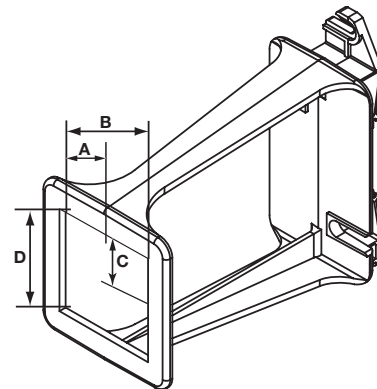

Dim. A	Dim. B	Dim. C	Dim. D
0.886 in. (23 mm)	1.772 in. (45 mm)	0.886 in. (23 mm)	1.772 in. (45 mm)

Rear View

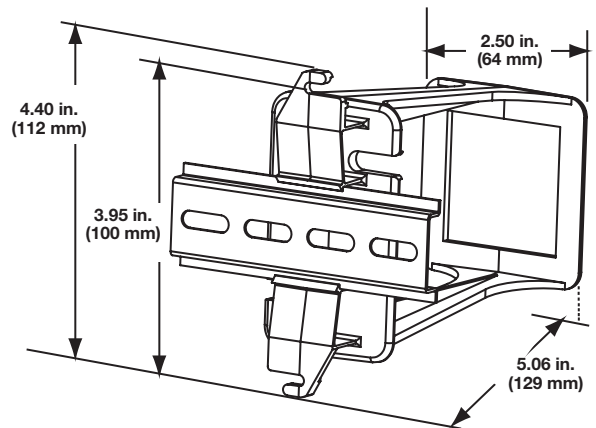

# Operator Interfaces

## EZ-ZONE RUI and Gateway

### Ordering Information

#### Part Number

<b>① ② ③</b>	<b>④</b>	<b>⑤</b>	<b>⑥</b>	<b>⑦ ⑧</b>	<b>⑨ ⑩</b>	<b>⑪ ⑫</b>
<b>EZK</b>	<b>Remote User Interface</b>	<b>Power Supply Voltage for RUI</b>	<b>Comm. Gateway Options</b>	<b>Custom RUI</b>	<b>Future Options</b>	<b>Custom Options</b>
		-			- <b>AA</b>	

<b>④</b>	<b>Remote User Interface (RUI)</b>
B =	Basic 1/16 DIN

<b>⑤</b>	<b>Power Supply Voltage for RUI</b>
L =	Low voltage 24-28VAC/VDC
H =	Universal high voltage 100-240VAC/VDC

<b>⑥</b>	<b>Communication Gateway Options* (Standard Bus Always Included)</b>
A =	None
2 =	EIA-232/485 Modbus® RTU
3 =	EtherNet/IP™/Modbus® TCP
5 =	DeviceNet™
6 =	PROFIBUS DP
* Options 2 through 6 require the long case dimensions	

<b>⑦ ⑧</b>	<b>Custom RUI</b>
AA =	None
XX =	Custom options, contact factory

<b>⑪ ⑫</b>	<b>Custom Options</b>
AA =	None
12 =	Class 1, Div. 2 (only available with communication options 2, 3, 5 and 6)

# Indicators

Product	Mounting	Display Height	Page
<b>EZ-ZONE® PM</b>	1/32, 1/16, 1/8, 1/4 DIN front panel	Upper/Left: 0.30 to 0.80 in. (8 to 20 mm) Lower/Right: 0.22 to 0.50 in. (6 to 13 mm)	<b>377</b>
<b>EZ-ZONE RUI and Gateway</b>	1/16 DIN front panel	Upper: 0.40 in. (10 mm) Lower: 0.24 in. (6 mm)	<b>378</b>
<b>SERIES TM</b>	DIN-rail, front panel, chassis	0.28 in. (7 mm)	<b>379</b>





# Indicators

## EZ-ZONE® PM

The EZ-ZONE® PM panel mount controller offers control options that reduce system complexity and thermal loop ownership cost. It can be ordered as a PID controller, an over/under limit controller or its functions can be combined into an integrated controller. An option to integrate a high amperage power controller output with a high-performance PID controller and an over/under limit controller in one space-saving, panel mount package is also available. Many communications options are offered to support connectivity needs.

Because the EZ-ZONE PM controller is highly scalable, pay only for what is needed. This controller is available in 1/32, 1/16, 1/8 and 1/4 DIN panel mount packages. The EZ-ZONE PM controller is easy to use and is ideal for PID, over/under limit or integrated controller needs.

### Features and Benefits

#### Integrated PID and limit controller

- Reduces wiring time and termination complexity compared with connecting discrete products
- Decreases required panel space
- Lowers installation costs
- Increases user and equipment safety for over/under temperature conditions

#### High amperage power control output

- Drives 15 ampere resistive loads directly
- Reduces component count
- Decreases cost of ownership

#### Current monitoring

- Detects heater current flow and provides alarm indication of a failed output device or heater load

#### Serial communication capabilities

- Provides a wide range of protocol choices including Modbus® RTU, EtherNet/IP™, Modbus® TCP, PROFIBUS DP and DeviceNet™
- Supports network connectivity to a PC or PLC

#### Dual-channel controller

- Provides two PID controllers in one space-saving package



#### Enhanced control options

- Easily handles complex process problems such as cascade, ratio, differential, square-root, motorized valve control without slidewire feedback, wet-bulb/dry-bulb, compressor control and peltier loads

#### Advanced PID control algorithm

- Offers TRU-TUNE®+ adaptive control to provide tighter control for demanding applications
- Provides auto-tune for fast, efficient startup

#### Configuration communications with software

- Includes Watlow standard bus communications and EZ-ZONE configurator software
- Saves time and improves reliability of controller setup

For detailed product and ordering information, see the full EZ-ZONE PM product section located on pages **249 through 257.**

# Indicators

## EZ-ZONE RUI and Gateway

The EZ-ZONE Remote User Interface (RUI and communications gateway) can be utilized as a communication gateway device to save cost, space and wiring when digital communications is being used with two or more EZ-ZONE controllers. The EZ-ZONE RUI can also serve as a display for showing all parameter values for up to 16 EZ-ZONE controllers, again saving cost, space and wiring expenses.

### Indicator Features and Benefits—Remote User Interface (RUI)

#### Single user interface device or location to access multiple controllers

- Easy accessibility to all controllers and all parameters from a central location by using one RUI display
- Reduces component material costs by using a single RUI to display multiple control zones
- Eliminates cost and complexity from bringing all controller related input and output wiring to the front panel

#### Flexible use of a display interface

- Can be used when needed during normal machine production, for OEM prototype design purposes or for remote troubleshooting scenarios
- Ability to use more than one RUI indicator to display additional data including temperature and current (ammeter) to improve user system interface

### Communications Gateway Features and Benefits

#### A single RUI and gateway provides field bus access for up to 16 EZ-ZONE controllers

- Lowers solution cost when field bus communications is required for multiple loops

#### Expand communication protocols to all EZ-ZONE controllers

- Ability to utilize multiple communication protocols for different user preferences. Flex between different communication protocols while still maintaining a reduced level of inventory



#### Delivers multiple communication protocol options

- Ability to connect EZ-ZONE controllers to communication networks utilizing
  - Modbus® RTU
  - DeviceNet™
  - Ethernet/IP™
  - Modbus® TCP
  - PROFIBUS DP

#### Additional Features

##### EZ-ZONE P3T armor sealing system

- Complies with NEMA 4X, IP65 RUI
- Offers water and dust resistance, can be cleaned and washed down

##### EZ-KEY (RUI)

- Programmable EZ-Key is a functional key programmable by the user to perform simple one-touch operation of repetitive user activities

##### Compact package

- Reduces required panel size for 1/6 DIN
- Utilizes less depth behind panel allowing for mounting in tight spaces

##### Touch-safe package

- Complies with IP2X which increases safety for user

##### Agency approvals: UL® Listed, CSA, CE, RoHS, W.E.E., SEMI F47-0200, Class 1, Div. 2 rating on selected models

- Meets applications requiring agency approvals

**For detailed product and ordering information, see the full EZ-ZONE RUI and Gateway product section located on pages 371 through 374.**

# Indicators

## SERIES TM

The SERIES TM temperature indicator from Watlow provides an economical solution for applications requiring temperature monitoring and display. Square 1/8 DIN panel mount and DIN-rail mount packaging options are available. A red, four-character, seven-segment LED display indicates the process value. The microprocessor-based design provides significant improvements in performance, repeatability and accuracy over analog indicators.

The indicators are UL® approved and include CE approvals. Panel mount indicators include NEMA 4X/IP65 seal protection. Watlow's SERIES TM temperature indicators include industry leading service and support and are backed by a three-year warranty.

### Features and Benefits

#### Four character LED display

- Improves accuracy

#### Multiple mounting options

- Minimizes installation time

#### Fahrenheit or Celsius operation with indication

- Offers application flexibility

#### Agency approvals

- Meets certification requirements/compliance

#### Microprocessor-based technology

- Ensures accurate repeatable indication

### Typical Applications

- Food preparation
- Industrial machinery
- Packaging
- Plastics processing



### Specifications

#### Operator Interface

- Four-digit, seven-segment LED displays, 7 mm (0.28 in.) high
- °F or °C indicator

#### Standard Conditions For Specifications

- Rated line voltage, 50 to 60Hz, 0 to 90% RH non-condensing, 15-minute warm-up
- Calibration ambient range: 77°F (25°C) ±3°C

#### Thermocouple Input

- Grounded or ungrounded
- Type E, J, K, T thermocouple types
- >10 MΩ input impedance
- 250 nV input referenced error per 1Ω source resistance

#### RTD Input

- 2-wire platinum, 100Ω
- DIN curve (0.00385 curve)
- 125 μA nominal RTD excitation current

#### Input Accuracy Span Range

Type E:	-328 to 1470°F	or	-200 to 800°C
Type J:	32 to 1382°F	or	0 to 750°C
Type K:	-328 to 2282°F	or	-200 to 1250°C
Type T:	-328 to 662°F	or	-200 to 350°C
RTD (DIN)	-328 to 1472°F	or	-200 to 800°C

#### Thermocouple Input Accuracy

- Calibration accuracy: ±1% of input accuracy span, ±1° at standard conditions and actual calibration ambient. Exception: Type T, ±2.4% of input accuracy span for -328 to 32°F (-200 to 0°C)
- Temperature stability: ±0.3° per degree change in ambient

# Indicators

## SERIES TM

### Specifications (Continued)

#### RTD Input Accuracy

- Calibration accuracy  $\pm 1\%$  of input accuracy span  $\pm 1^\circ$  at standard conditions and actual calibration ambient
- Temperature stability:  $\pm 0.2^\circ$  per degree change in ambient

#### Indication Ranges

Type E:	-328 to 1470°F	or	-200 to 800°C
Type J:	-346 to 1900°F	or	-210 to 1038°C
Type K:	-454 to 2500°F	or	-270 to 1370°C
Type T:	-454 to 750°F	or	-270 to 400°C
RTD (DIN)	-328 to 1472°F	or	-200 to 800°C

#### Agency Approvals

- CE<sup>①</sup>, W.E.E.E., RoHS EU Directive (2002-95-EC)
- UL<sup>®</sup> 873 recognized temperature indicator, File # E43684
- UL<sup>®</sup> 197 reviewed for use in foodservice appliances
- Temperature indicator CSA 22.2 No. 24, File # 30586
- Front panel mount models with gasket
  - UL<sup>®</sup> 50 Type 4X indoor use only
  - NEMA 4X/IP65 approved

#### Terminals

- 0.25 in. (6.3 mm) quick connect, push on terminal or removable screw style terminal block

#### Power

- 24VAC +10%; -15%; 50/60Hz,  $\pm 5\%$
- 120VAC +10%; -15%; 50/60Hz,  $\pm 5\%$
- 230 to 240VAC +10%; -15%; 50/60Hz,  $\pm 5\%$
- 10VA max. power consumption

#### Operating Environment

- 32 to 158°F (0 to 70°C)
- 0 to 90% RH, non-condensing
- Storage temperature: -40 to 185°F (-40 to 85°C)

#### Dimensions

- DIN-rail model can be DIN-rail or chassis mount  
DIN-rail spec DIN 50022, 1.38 x 0.30 in. (35 x 7.5 mm)

Style	Width	Height	Depth
DIN-rail	3.08 in. (78.1 mm)	4.42 in. (112.3 mm)	3.57 in. (90.7 mm)
Square 1/8 DIN Panel	2.85 in. (72.4 mm)	2.85 in. (72.4 mm)	Behind panel 2.04 in. (51.7 mm)

① See declaration of conformity.

## Ordering Information

Indicator only, 4-character, 7-segment display

### Part Number

① ②	③	④	⑤	⑥	⑦ ⑧ ⑨ ⑩	⑪ ⑫ ⑬ ⑭	⑮
TM	Power Supply	Package	Sensor Type & Scale	A	AAAA	AAAA	Overlay/Custom Options

③ Power Supply	
B =	120VAC
D =	230 to 240VAC
F =	24VAC

④ Package	
1 =	Panel mount, 1/8 in. DIN square - spade terminals
2 =	DIN-rail mount - spade terminals
5 =	Panel mount, 1/8 in. DIN square - screw terminals
6 =	DIN-rail mount - screw terminals
A =	NEMA 4X panel mount, - spade terminals
C =	NEMA 4X panel mount, - screw terminals

⑤ Sensor Type & Scale	
H =	T/C Type J °F (-346 to 1900°F)
J =	T/C Type J °C (-210 to 1038°C)
K =	T/C Type K °F (-454 to 2500°F)
L =	T/C Type K °C (-270 to 1370°C)
M =	T/C Type T °F (-454 to 750°F)
N =	T/C Type T °C (-270 to 400°C)
P =	RTD °F (-328 to 1472°F)
R =	RTD °C (-200 to 800°C)
S =	T/C Type E °F (-328 to 1470°F)
T =	T/C Type E °C (-200 to 800°C)

⑮ Overlay/Custom Options	
A =	Standard with Watlow logo
1 =	Standard without Watlow logo



# Data Loggers

Product	Description	Supported Controllers	Operating Requirements	Page
<b>F4T With INTUITION®</b>	1 to 24 Channels	F4T and Flex Modules (FM)	None	<b>383</b>
<b>EZ-ZONE® RM System with Access Module</b>	Multi-loop controller with data logging ability	EZ-ZONE RM	None	<b>384</b>
<b>SpecView HMI Software</b>	Human machine interface for Watlow controllers	See catalog page 386	Windows® 10, 8.1, 8, 7, Vista, Server 2003, XP (Home and Professional), 2000, NT 4.0, ME, 98 and 95	<b>385</b>
<b>Silver Series EM</b>	Rugged, touch screen operator interface terminal	EZ-ZONE and many others	EZwarePlus: Windows® 10, 8.1, 8, 7, Vista and XP	<b>390</b>
<b>WATVIEW HMI Software</b>	Human machine interface for older Watlow controllers	See catalog page 392	Windows® XP	<b>391</b>

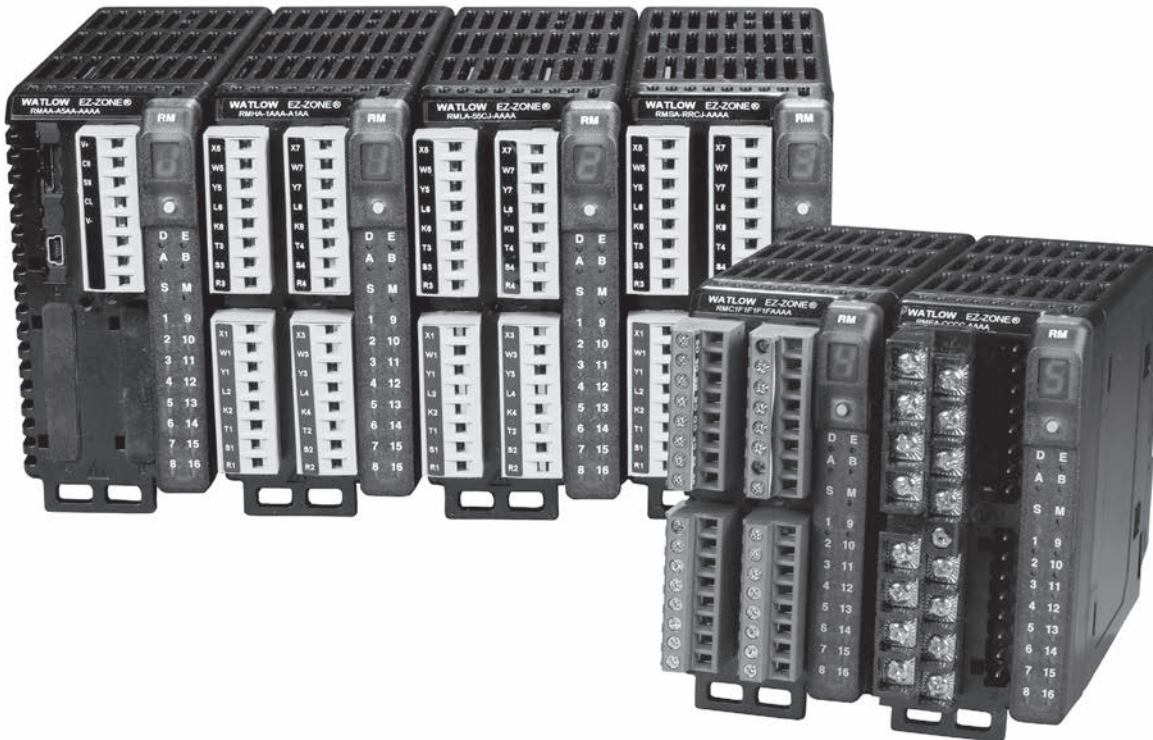



# Data Loggers

## F4T With INTUITION®

The F4T with INTUITION® temperature process controller offers a wide range of field removable I/O modules for maximum design flexibility. Configurations can be custom tailored to meet the scaling needs of a tremendous range of equipment and applications while providing exactly the hardware types required for compatibility. The F4T controller also features a 4.3 inch, color, graphical touch panel. Combining power, flexibility and functionality, this new controller offers unmatched versatility, and its best-in-class ease of use could very well make user manuals a thing of the past.

### Features and Benefits

#### 4.3-inch, color touch panel with high-resolution, graphical user-interface

- Shortens learning curve and reduces operator errors
- Allows channels, profiles, alarms, inputs and outputs to be personalized with user defined names

#### Temperature PID, data logger, trend chart, over/under-temperature limit, power switching, math, logic, timers and counters combined into an integrated system

- Lowers ownership costs
- Eliminates the need for separate discrete components
- Reduces complexity
- Simplifies design, ordering and installation
- Saves money

#### Robust algorithms for temperature, cascade, altitude, humidity and compressor

- Improves process control
- Offers one to four channels of control
- Provides multiple PID sets
- Enables TRU-TUNE®+ adaptive control algorithm
- Offers 40 ramp and soak profiles with real-time clock and battery backup

#### COMPOSER® graphical configuration PC software

- Speeds up and simplifies commissioning
- Archives and documents controller setup
- Connects with controller easily via Ethernet

#### Many communications options available including Ethernet Modbus® TCP and SCPI and EIA-232/485 Modbus® RTU

- Offers two USB host ports and one device port
- Simplifies file transfers
- Connects easily



#### Modular design

- Adapts quickly to evolving requirements
- Offers numerous types of field pluggable modules for maximum flexibility and easiest compatibility
- Features scalable and modular firmware functions
- Delivers scalable input/output quantities from 1 to 36

#### Agency certifications include UL®, FM, CE, RoHS, W.E.E.E., NEMA 4X/IP65

- Ensures high quality and reliability
- Verifies performance in installations worldwide

#### SERIES F4S/F4D/F4P backward compatible

- Provides easy retrofit with minimum pain and disruption
- Ensures proper fit in existing SERIES F4 panel cutout

#### Off-the-shelf solution

- Provides cost-effective “make versus buy”
- Offers preconfigured touch-panel screens
- Assures quicker time to market

For detailed product and ordering information, see the full F4T product section located on pages **211 through 221.**

# Data Loggers

## EZ-ZONE® RM System with Access Module

The EZ-ZONE® RM controller simplifies thermal system management. The EZ-ZONE RM controller family is comprised of six module types: an integrated on-off or PID control, monitoring and over/under temperature limit module, a high-density on-off or PID control module, a high-density limit only module, an input/output (I/O) expansion module, a high-density monitor/scanner module and a data logging and field communications access module. A system is configured by connecting any combination of module types to address specific application needs. The EZ-ZONE RM is extremely flexible and scalable allowing mixing and matching of I/O to configure one to 152 control loops and up to 256 monitor points.

### Optional integrated controller functions can be combined or ordered in different quantities:

- PID control loops
- Over/under temperature limit control loops
- 10 and 15 ampere power output/heater driver options
- On-board data logging
- Current measurement input
- Sequencer start up and control function
- Programmable timer and counter functions
- Programmable math and logic options
- Multiple communication protocol options
- Mobile configuration with removable secure digital (SD) flash card

### Benefits of using an integrated controller solution:

- Reduces wiring time and termination complexity compared with connecting multiple discrete products
- Improves system reliability
- Reduces termination and installation cost
- Eliminates compatibility issues often encountered with using various discrete components and brands
- Reduces troubleshooting time and downtime costs because the system can specifically identify any problems with a sensor, controller, solid state relay (SSR) power output or heater load
- Complete thermal solution saves engineering time and labor costs while shortening project schedules

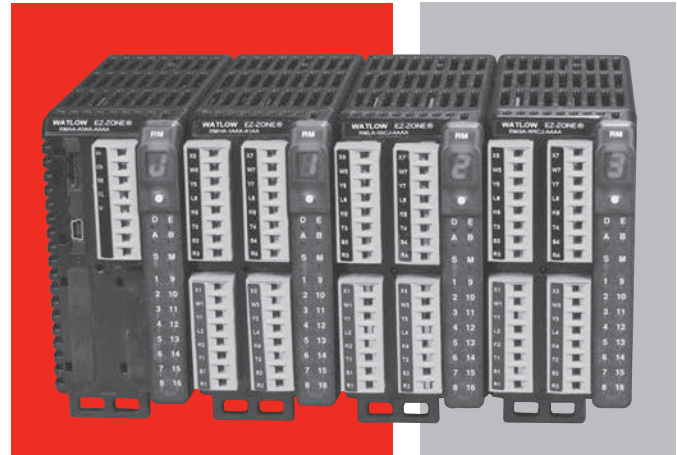

## Features and Benefits

### Multiple inputs; from one to 152 PID loops of control or monitor up to 256 analog inputs

- Mix and match I/O to fit any application; from one input with two outputs to 152 analog inputs with 152 outputs, or monitor up to as many as 256 analog inputs all in one system
- Reduces cost because only required loops are purchased
- Allows a common controller platform across many design applications as both loops and outputs can be ordered in single increments

### Advanced PID control algorithm

- Offers TRU-TUNE®+ adaptive control to provide tighter control for demanding applications
- Enables auto-tune for fast, efficient start-up

### Communication capabilities

- Provides a range of protocol options including universal serial bus (USB) device port, Modbus® RTU, EtherNet/IP™, Modbus® TCP, DeviceNet™ and PROFIBUS

### USB Port

- Provides data log retrieval

### SPLIT-RAIL control

- Enables modules mounted in separate high-voltage and low-voltage cabinets to function as an integrated system
- Minimizes the length and cost of wire runs and improves system reliability by locating inputs closer to sensors and outputs closer to loads

**For detailed product and ordering information, see the full EZ-ZONE RM product section located on pages 222 through 239.**

# Data Loggers

## SpecView HMI Software

SpecView software is an easy-to-use Human Machine Interface (HMI) to Watlow controllers, including the F4T with INTUITION process controller and EZ-ZONE controllers as well as third-party products. Watlow's single point of support for hardware, software and application needs ensures knowledgeable and expedient responses to questions or concerns.

This competitively priced package includes field-proven features, many suggested by loyal users. Built-in support and auto-detect for Watlow controllers make setup quick and simple. SpecView is ideal for industrial applications with support for barcode readers and touch-screen operation.

To try before purchasing, download SpecView from the Watlow website and run in the time-limited demo mode.

### Features and Benefits

#### Built-in support and auto-detect for controllers

- Saves set-up time
- Eliminates the need to learn communications protocols
- Integrates devices from multiple vendors

#### Watlow EZ-ZONE standard bus communications protocol

- Communicates with any EZ-ZONE product without requiring purchase of a communications option

#### Highly configurable trending/graphing

- Simplifies monitoring and troubleshooting processes and machines
- Provides a permanent, unalterable record of results

#### Flexible data logging and report generator

- Helps users comply with regulatory requirements including AMS 2750D NADCAP
- Reduces labor and increases accuracy by automating data collection
- Simplifies record keeping by consolidating measurements, operator comments and other information into Excel® - compatible report formats
- Allows data to be grouped in user-defined batches
- Records operator actions

#### Easy-to-build, customizable screens

- Allows creation of application-specific screens, which can automate tasks, decrease training time and simplify monitoring and operation
- Highlights specific parameter values with user-set color dynamics and provides bar graphs for "at-a-glance" monitoring
- Limits access with passwords if desired

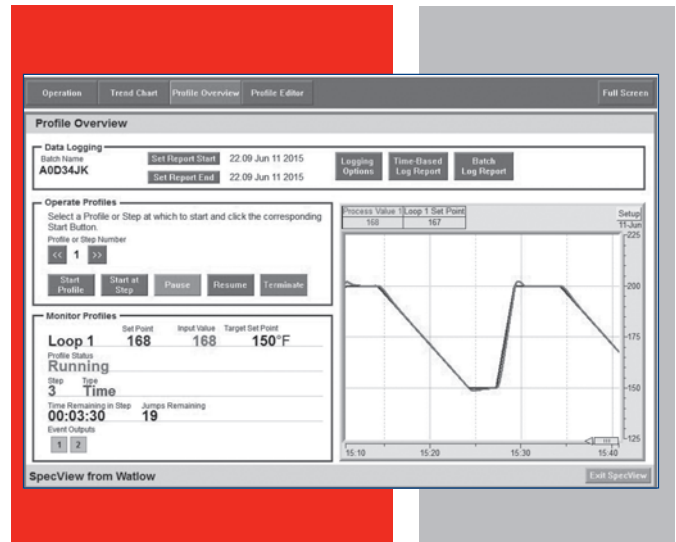

#### Easy-to-use recipe manager

- Saves snapshot of current parameter settings
- Eliminates operator error when setting machine parameters
- Reviews and edits complex programmer profiles

#### Historical replay option

- Helps troubleshoot processes by allowing review of recorded data

#### Remote access option

- Allows multiple, identical operator stations for convenient access
- Reduces downtime and increases utilization with monitoring and access over LAN, modem or Internet

### System Requirements

#### Compatible Operating Systems:

- Windows® 10, 8.1, 8, 7, Vista, Server 2003, XP, 2000, NT 4.0, ME, 98 and 95

#### Minimum System:

- Pentium® processor or equivalent AMD
- 1GB RAM (2GB or more recommended)
- 100MB hard disk space to install SpecView
- Additional disk space for data logging
- Instrument connection: serial port or Ethernet
- USB port for the key

#### Ideal System:

- Intel® Core™ i5 2.6Ghz processor or AMD equivalent
- 2GB RAM
- 500GB hard disk plus enough space for data logging

# Data Loggers

## SpecView HMI Software

### Supported Controllers and Protocols

Controller	Controller's Communication Protocol		
	Standard Bus	Modbus® RTU	Modbus® TCP
F4T with INTUITION	N/A	✓	✓
EZ-ZONE RM, PM and ST	✓	✓ <sup>①</sup>	✓ <sup>①</sup>
SERIES F4 Ramping	N/A	✓	N/A
SERIES 96, 97, SD	N/A	✓	N/A
POWER SERIES	N/A	✓	N/A
MICRODIN	N/A	✓	N/A
SERIES 986, 987, 988, 989	N/A	✓	N/A
CLS200 (standard or ramp/soak)	N/A	✓	N/A
MLS300 (standard or ramp/soak)	N/A	✓	N/A

<sup>①</sup> Modbus® support for basic operation parameters is included. Automatic detection of EZ-ZONE instruments is not available via Modbus® so configurations must be set up manually. EZ-ZONE ST controllers versions 1 to 3 are supported via Modbus® with a RUI Gateway only.

### Application Examples



Track and report batch-specific processing data.



Graph and log process data. Replay data that may have been missed while a user was away. For playback of data older than four hours get the historical replay option.

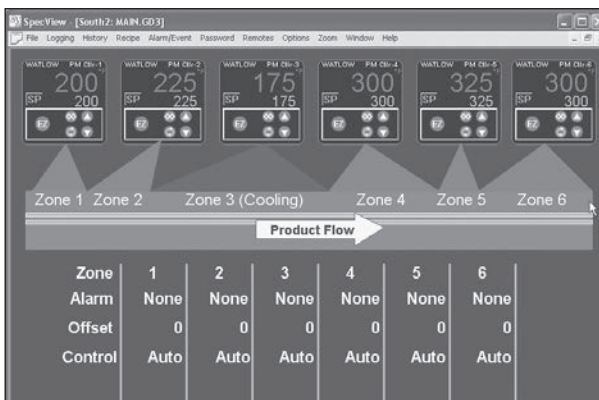

Create application-specific screens that depict process data so users can relate.

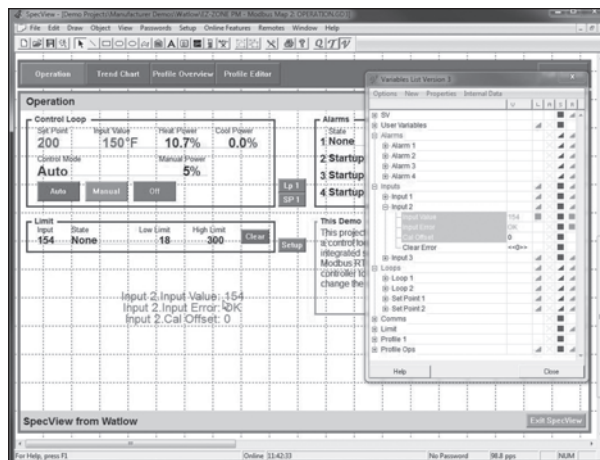

Make screens with drag-and-drop ease.

# Data Loggers

## SpecView HMI Software

### Ordering Information - Standard

#### Part Number

① ②	③	④	⑤	⑥	⑦	⑧ ⑨	⑩	⑪	⑫	⑬
SV	Version S	Ports	Historical Replay & Strategy Cont.	DDE and OPC	ActiveX Container	Remote Users	Special Watlow Drivers	Third Party Drivers	Update Plan	0

③ Version	
S =	Standard
④ Ports	
S =	Single
M =	Multiple
⑤ Historical Replay and Strategy Controller	
0 =	None
H =	Historical replay
S =	Strategy controller
B =	Both
⑥ DDE and OPC	
0 =	None
D =	DDE
C =	OPC client
B =	Both
⑦ ActiveX Container	
0 =	None
A =	ActiveX container

⑧ ⑨ Remote Users	
00 =	None
XX =	Number of simultaneous remote users (01 to 99)
⑩ Special Watlow Drivers	
0 =	None
1 =	SERIES F4 programmer
⑪ Third Party Drivers	
0 =	None
1 =	Allen-Bradley® DF1
<b>Note:</b> Special drivers for other third-party products (Honeywell, Eurotherm, Mitsubishi, Yokogawa and Marathon) are available directly from SpecView.	
⑫ Update Plan	
0 =	One year of free updates
5 =	Five additional years of updates (six years total)

### Ordering Information - Mini

#### Part Number

① ②	③	④	⑤	⑥	⑦	⑧ ⑨	⑩	⑪	⑫	⑬
SV	Version M	Ports	Historical Replay & Strategy Cont.	DDE and OPC	ActiveX Container	Remote Users	Special Watlow Drivers	Third Party Drivers	Update Plan	0

③ Version	
M =	Mini (limited to two instrument views)
<b>Note:</b> The mini version is limited to two instrument views and may not be appropriate for use with some devices such as profiling and multi-loop controllers where a single device appears as multiple instruments in SpecView.	
④ Ports	
S =	Single
M =	Multiple
⑤ Historical Replay and Strategy Controller	
H =	Historical replay
B =	Historical replay and strategy controller
⑥ DDE and OPC	
0 =	None
D =	DDE
C =	OPC client
B =	Both

⑦ ActiveX Container	
0 =	None
A =	ActiveX container
⑧ ⑨ Remote Users	
00 =	None
XX =	Number of simultaneous remote users (01 to 99)
⑩ Special Watlow Drivers	
0 =	None
1 =	SERIES F4 programmer
⑪ Third Party Drivers	
0 =	None
1 =	Allen-Bradley® DF1
<b>Note:</b> Special drivers for other third-party products (Honeywell, Eurotherm, Mitsubishi, Yokogawa and Marathon) are available directly from SpecView.	
⑫ Update Plan	
0 =	One year of free updates
5 =	Five additional years of updates (six years total)

# Data Loggers

## SpecView HMI Software

### Ordering Information - Upgrade

#### Part Number

① ②	③	④	⑤	⑥	⑦	⑧ ⑨	⑩	⑪	⑫	⑬
	Version	Ports	Historical Replay & Strategy Cont.	DDE and OPC	ActiveX Container	Remote Users	Special Watlow Drivers	Third Party Drivers	Extend or Restart Update Plan	
SV				-			-			0

③ Version	
U =	No version change; upgrade options only
N =	Upgrade mini to standard

④ Ports	
0 =	No upgrade
M =	Multiple

⑤ Historical Replay and Strategy Controller	
0 =	No upgrade
H =	Historical replay (already included with SpecView Mini)
S =	Strategy controller
B =	Both (do not order this option with SpecView Mini)

⑥ DDE and OPC	
0 =	No upgrade
D =	DDE
C =	OPC client
B =	Both

**Note:** Your upgrade order must be accompanied by the Step 1 code from the Upgrade screen in SpecView. Use the upgrade order form available at [www.watlow.com](http://www.watlow.com) or upon request from Watlow or your authorized distributor.

⑦ ActiveX Container	
0 =	No upgrade
A =	ActiveX container

⑧ ⑨ Remote Users	
00 =	No upgrade
XX =	Number of simultaneous remote users (01 to 99)

⑩ Special Watlow Drivers	
0 =	No upgrade
1 =	SERIES F4 programmer

⑪ Third Party Drivers	
0 =	No upgrade
1 =	Allen-Bradley® DF1
<b>Note:</b> Special drivers for other third-party products (Honeywell, Eurotherm, Mitsubishi, Yokogawa and Marathon) are available directly from SpecView.	

⑫ Extend or Restart Update Plan	
0 =	No additional updates
2 =	Extend update plan by two years. <b>Note:</b> Valid only <b>prior</b> to expiration of the update plan.
5 =	Extend update plan by five years. <b>Note:</b> Valid only <b>prior</b> to expiration of the update plan.
U =	Start a new two-year update plan. <b>Note:</b> Select this option to update SpecView after its update plan has expired.
A =	Start a new two-year update plan. <b>Note:</b> Valid one time only when upgrading from version 2.5 to version 3.



# Data Loggers

## SpecView HMI Software

### How to Choose the Correct SpecView Options

Order this option...	If you want to...
<b>Mini Version</b>	Operate a system with data from one or two simple instruments. This option includes historical replay and allows up to two instruments. Note that in some cases, devices such as profiling and multi-loop controllers are represented by more than one instrument, the mini version may not be appropriate.
<b>Standard Version</b>	Be free to expand configurations beyond the two instrument limit of the mini version.
<b>Single Port</b>	Communicate with instruments on only one serial communications port or only via Ethernet only.
<b>Multiple Port</b>	Communicate with instruments on more than one serial communications port and via Ethernet.
<b>Historical Replay</b>	Replay logged data on screens in trends, bar graphs and numeric fields. Without the option, replay is limited to the last four hours of data.
<b>Strategy Controller</b>	Configure SpecView to respond automatically to events such as specific parameter values with actions such as printing the screen, starting logging or download a recipe. Events can also be time or calendar based. Without the strategy controller option there is a two event limit.
<b>DDE</b>	Integrate SpecView with other Windows® programs.
<b>OPC Client</b>	Connect SpecView to instruments via a third-party OPC server.
<b>ActiveX Container</b>	Integrate third-party or customer-written ActiveX controls into SpecView.
<b>Remote Users</b>	Monitor instruments from multiple computers simultaneously. Order the number of remote users corresponding to the maximum number of additional computers needed to connect simultaneously.
<b>SERIES F4 Programmer Driver</b>	Use the computer to manage profiles: program profiles in the computer, save profiles on the computer, or download profiles that are saved on the computer to the SERIES F4.
<b>Allen-Bradley® DF1 Driver</b>	Connect to Allen-Bradley® PLCs (process logic controllers) that support the DF1 protocol
<b>Update Plan</b>	SpecView includes one year of free updates with an option for five additional years. The update period may be extended or restarted with field upgrade options.

# Data Loggers

## Silver Series EM

The Silver Series EM is a rugged, touch-screen operator interface terminal (OIT). Available in three sizes (4.3, 7 and 10 inch diagonal display sizes), the OIT's feature serial and Ethernet communications with multiple controllers, email messaging, universal serial bus (USB host), data logging, flexible password security and multiple languages. The small bezel size and two-inch depth make mounting in tight spots easy.

The Silver Series EM programming software, EZwarePlus, is easy to use and features a large variety of built-in screen objects that makes it powerful. When creating screens, the user can call upon extensive graphics libraries, import custom graphics and add numeric displays, entry fields, analog meters, bar graphs and trend graphs with just a few mouse clicks. Screen objects are highly customizable, and the user can create libraries of their own objects for repeat use. The online simulator, Ethernet and USB support make testing and downloading fast. The EZwarePlus screen editor is part of the EZwarePlus software suite and is available as a FREE download on [www.watlow.com](http://www.watlow.com) and on the DVD-ROM found in the accessories list on page 370.

The Silver Series EM OIT paired with Watlow controllers is the perfect solution for your industrial process or machine control application.

### Features and Benefits

#### Bright, color, high resolution, graphic, touch screen, thin film transistor (TFT) display

- Maximizes display space in the OIT footprint
- Allows application specific interface design
- Allows viewing from a distance and at an angle
- Highlights important process information with color and animation

#### User selectable portrait or landscape operation

- Fits in tight spots



#### Ethernet, serial and USB host ports

- Allows options for connecting to controllers
- Provides options for downloading projects
- Expands memory for additional recipe and data log storage
- Supports barcode readers, keyboard, mouse and printers
- Supports monitoring from a personal computer (PC) with free virtual network computing (VNC) client software

#### Support for over 100 protocols, up to three simultaneously plus multiple protocols over Ethernet

- Connects to a wide range of industrial controllers and devices
- Integrates a variety of devices to simplify complex operation tasks

#### Data logging, display and trending

- Helps operators monitor processes
- Reduces labor and increases accuracy by automating time-stamped data collection
- Stores captured data for future retrieval in multiple files
- Saves time by exporting data to Excel®-compatible comma separated value (.csv) files
- Improves process understanding by allowing live and historical data to be viewed on the OIT

For detailed product and ordering information, see the full Silver Series EM product section located on pages **365 through 370.**

# Data Loggers

## WATVIEW™ HMI Software

**Note: WATVIEW™ is not compatible with versions of Windows® after Windows® XP and does not support Watlow EZ-ZONE controllers. Please consider SpecView for your HMI software needs.**

WATVIEW is Watlow's Human/Machine Interface (HMI) software for older Watlow controllers. WATVIEW features easy controller setup, recipe and alarm managers, data-logging and trend plot graphing.

WATVIEW is available in three editions:

- **Run-Time Edition**—for operating controllers
- **Developer Edition**—creates custom screens
- **Configurator Edition**—available free of charge for setting up controllers at [www.watlow.com](http://www.watlow.com)

**Note:** See the Edition Comparison Table on the next page for details about which features are in each edition.

### Features and Benefits

#### Easy program setup

- Scans all available communications ports and baud rates for supported controllers
- Detects which controllers are connected to the computer
- Automatically configures with appropriate setup screens and help files for detected controllers

#### Controller specific setup and spreadsheet overview screens

- Simplify monitoring and adjusting controller parameters
- Display settings for multiple channels and controllers
- Present parameters according to controller's menus

#### Recipe manager

- Stores commonly used controller settings
- Speeds up repetitive controller setups
- Backs up "snapshot" of your settings against data loss

#### Calendar-start function

- Automates processes by downloading recipes automatically in a one-time or repeating schedule

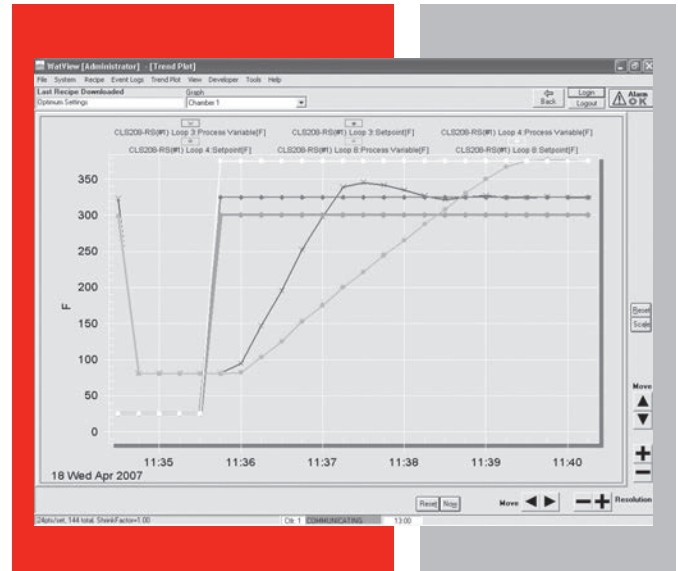

#### Alarm manager

- Makes alarms easier to understand with customizable, plain text messages
- Aids in troubleshooting by time stamping and logging alarms
- Streamlines alarm management by allowing monitoring, acknowledging and clearing alarms for multiple controllers

#### Data-logging and trend plot graphs

- Reduce labor and increase accuracy by automating data collection for the parameters you choose
- Save time by exporting data to Excel®-compatible spreadsheet files
- Simplify process adjustments and troubleshooting by graphing up to 20 data items together on a graph
- Provide flexibility by allowing users to name, save and choose for display from any number of graphs

# Data Loggers

## WATVIEW HMI Software

### Specifications

#### Windows® XP System Requirements:

- RAM: 128 MB
- 800 x 600 screen resolution
- 16-bit or higher color palette (“High Color”)
- Serial communications (COM) or Ethernet port
- Microsoft® compatible pointing device (mouse or trackball)
- Parallel or USB port
- 200 MB hard drive space
- CD-ROM drive or Internet connection (for installation only)

#### Controllers Supported:

WATVIEW supports the following controllers when equipped with the listed firmware revision or later:

- CAS200 (Rev. 2.0)
- CLS200 SERIES standard, enhanced, and extruder (Rev. 3.31), ramp and soak (Rev. 3.40)
- CPC400 SERIES (Rev. 1.00)
- F4S/F4D (Rev. 2.06), F4P (3.00)
- MICRODIN™ (Rev. 1.01)
- MLS300 SERIES standard, enhanced, and extruder (Rev. 3.31), ramp and soak (Rev. 3.40)
- POWER SERIES (Rev. 1.00)
- SERIES 96 (Rev. 1.20)
- SERIES 96 with ramping (Rev. 1.05)
- SERIES 97 (Rev. 1.10)
- SERIES SD controller (Rev. 4.00), profiling (Rev. 1.00), single-display controller (Rev. 2.00), limit (Rev. 2.00)

**Note:** See [www.watlow.com/products/software/watview.cfm](http://www.watlow.com/products/software/watview.cfm) to download the latest version or get a free copy of the WATVIEW Configurator edition.

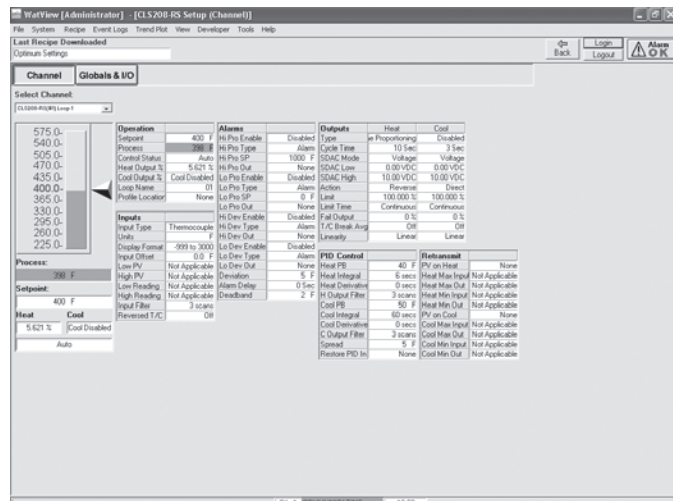

Setup screens make it easy to configure controllers.

### Edition Comparison Table

	Developer	Runtime	Configurator
<b>Process Monitoring Features</b>			
Spreadsheet overview	Yes	Yes	Yes
Controller setup screens	Yes	Yes	Yes
Viewing custom screens	Yes	Yes	Yes
Alarm management	Yes	Yes	
Creating and editing custom screens	Yes		
Editing user variables	Yes		
<b>Process Management and Documenting Features</b>			
Editing and downloading recipes	Yes	Yes	Yes
Calendar-based, automatic recipe start	Yes	Yes	
Event logging	Yes	Yes	
Data logging	Yes	Yes	
Trend plot graphing	Yes	Yes	
<b>Utility Features</b>			
Multiple-controller support	Yes	Yes	Yes
Communications diagnostics	Yes	Yes	Yes
Password security	Yes	Yes	Yes
Customizable parameter names	Yes	Yes	Yes
Online help	Yes	Yes	Yes
Active X (OLE 2.0) support	Yes	Yes	Yes
Personal webserver compatibility	Yes	Yes	Yes

### Ordering Information

#### Part Number

①	②	③	④	⑤	⑥	⑦	⑧	⑨	⑩	⑪	⑫
				Edition		Key Type					
WV00				-	0		0	-	0000		

⑤ Edition	
D =	Developer
R =	Runtime
⑦ Key Type	
P =	Parallel Port (LPT)
U =	USB

Product	Description	Supported Controllers	Operating Requirements	Page
<b>COMPOSER® With INTUITION®</b>	Software for configuring Watlow controllers	F4T and EZ-ZONE RM	Windows® 8.1, 8 and 7	<b>395</b>
<b>EZ-ZONE® Configurator</b>	Software for configuring EZ-ZONE products	EZ-ZONE controllers	Windows® 8 and 7	<b>397</b>
<b>EZ-ZONE LabVIEW™ Driver</b>	Virtual instruments (VIs)/driver to interface LabVIEW™ with EZ-ZONE products via standard bus	EZ-ZONE controllers	LabVIEW™ versions 8.6 and later	<b>399</b>
<b>EZ-ZONE GSD Editor</b>	Software for creating PROFIBUS GSD files for EZ-ZONE products	EZ-ZONE controllers	Windows® 8 and 7	<b>400</b>
<b>EHG® SL10 Software</b>	Software for configuring and monitoring EHG SL10 controller	EHG SL10	Windows® XP Professional	<b>401</b>
<b>SpecView HMI Software</b>	Human machine interface for Watlow® controllers	See catalog page 386	Windows® 10, 8.1, 8, 7, Vista, Server 2003, XP (Home and Professional), 2000, NT 4.0, ME, 98 and 95	<b>402</b>
<b>EZwarePlus</b>	Silver Series EM OITs	Silver Series EM OITs	Windows® 10, 8.1, 8, 7, Vista and XP	<b>403</b>
<b>WATVIEW™</b>	Human Machine Interface for older Watlow controllers	See catalog page 392	Windows® XP	<b>405</b>

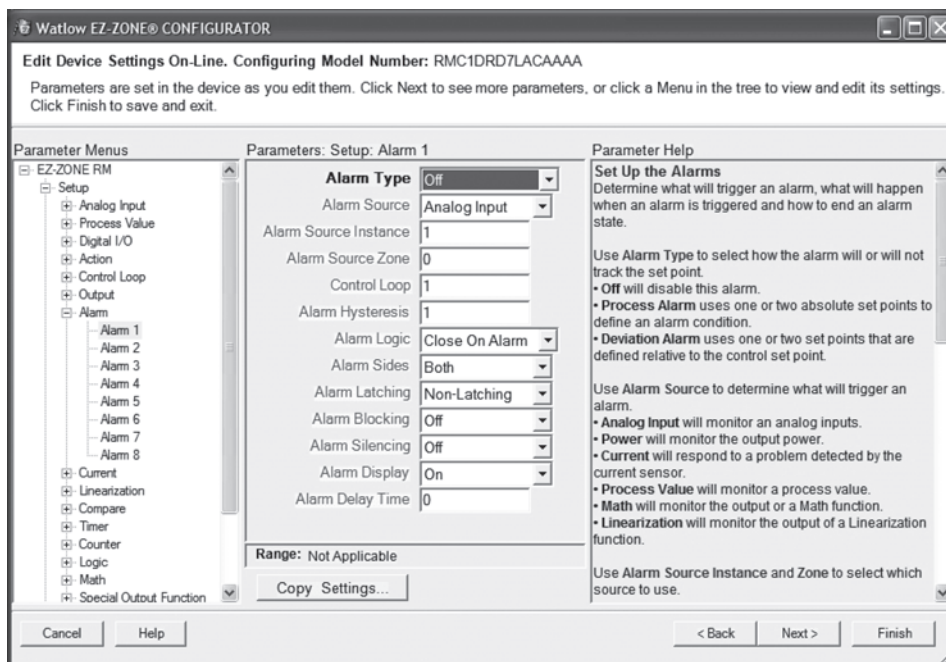



# Software

## COMPOSER® With INTUITION®

COMPOSER® with INTUITION® is Watlow's new, easy-to-use software for configuring and customizing controllers. Use it to optimize Watlow's F4T and EZ-ZONE® RM controllers for specific applications. Task-specific views simplify all aspects of commissioning new controllers including managing the inputs and outputs from pluggable flex modules, setting up functions such as control loops and alarms and creating and editing profiles. COMPOSER software is included on the "Watlow Support Tools" DVD and available for download at [www.watlow.com](http://www.watlow.com).

### Features and Benefits

#### Function block diagram with live data and error indication

- Enables application-specific configuration of controller functions
- Depicts the configuration visually making it easy to understand
- Simplifies explaining the application to others
- Speeds up application testing and troubleshooting
- Illustrates connections between physical inputs and outputs and controller software functions
- Indicates process values and errors simplifying validation

#### Multi-language support

- Prevents errors by communicating with users in their own languages

#### System image files contain complete configuration

- Makes it fast and easy to duplicate settings from one system to another
- Simplifies sending configurations to remote sites
- Provides backup of settings to restore if settings are changed or controller is replaced

#### Dashboard view

- Makes it easy to connect to controllers
- Clearly indicates when there are configuration errors that need to be addressed
- Allows downloading configuration files without allowing access to setup and configuration views

#### Configurable interface

- Lets users adjust window sizes and positions to work efficiently

#### Integrated video tutorials and help

- Speeds up commissioning by demonstrating configuration steps
- Simplifies access to function block and parameter descriptions
- Reduces configuration errors
- Helps the user take full advantage of available features

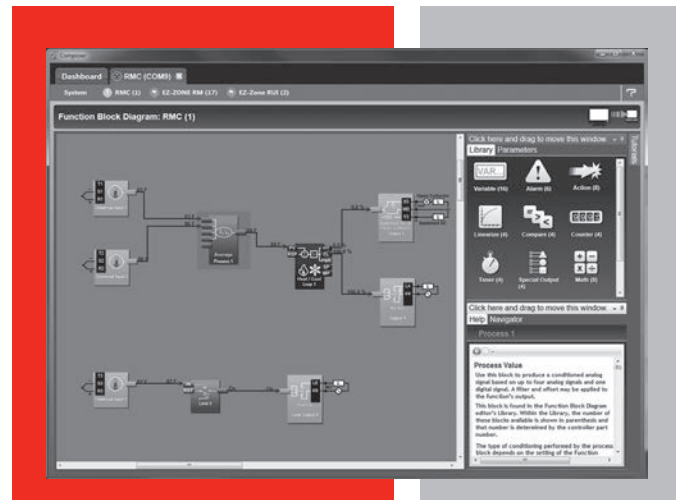

### Illustrations from COMPOSER

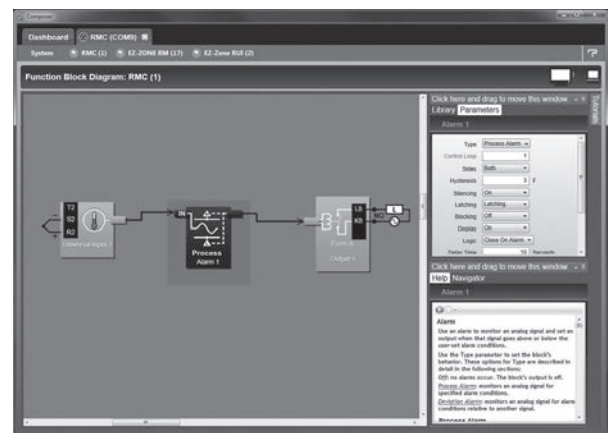

Function block diagram makes it easy to visualize application solutions.

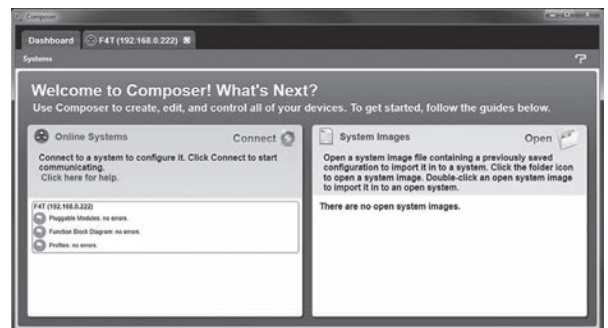

Dashboard makes it easy to connect, indicates configuration errors and allows downloading configuration files without allowing access to setup.

## COMPOSER With INTUITION

### Technical Data

#### Additional Features and Benefits for F4T

##### Profile editor

- Speeds up profile creation and editing
- Allows maintenance of profile list in controllers from a remote PC
- Makes it easy to move profiles from one controller to another
- Exports profiles to PC files for backup and portability

##### Fast, reliable Ethernet support

- Easily connects to one or more controllers
- Minimizes time to read and write configuration settings

##### Pluggable flex module management

- Simplifies configuration by clearly indicating which hardware is present
- Shortens commissioning by allowing user to configure controller for flex modules prior to installing them

##### Security configuration

- Allows OEMs and supervisors to limit permissions to specific features
- Controls access via COMPOSER and controller
- Prevents errors and reduces downtime by preventing undesired configuration changes

##### Calibration view with on-screen instructions and automation

- Reduces downtime by simplifying the calibration verification procedure

#### Features by Supported Product

Feature	EZ-ZONE				
	F4T	RM	RUI	PM	ST
Connect via Ethernet	✓				
Connect via 485		✓	✓	✓	✓
Function block diagram view	✓	✓			
System overview	✓	✓	✓	✓	✓
Device details	✓	✓	✓	✓	✓
Save and import system images	✓	✓	✓	✓	✓
Pluggable modules view	✓				
Password security setup	✓				
Calibration utility	✓				
Ramp and soak profile editing	✓				

**Note:** When a system includes an EZ-ZONE PM or EZ-ZONE ST, it appears in the system overview, is supported with a device details view and its settings are saved and imported with system image files, but no other functionality is supported at this time.

## Specifications

### Supported Products

Product	Minimum Version
F4T with INTUITION	2.0
EZ-ZONE RM: RMC, RME, RMS, RMH, RML	9
EZ-ZONE RM: RMA	5
EZ-ZONE RUI	6

### Compatible Operating Systems

- Windows® 8.1
- Windows® 8
- Windows® 7

### Minimum System Requirements

- Microprocessor: 1 gigahertz (GHz) or faster 32-bit or 64-bit
- Memory: 1 gigabyte (GB) RAM (32-bit) or 2 GB RAM (64-bit)
- Disk space: 250 megabytes (MB)
- Video: 1280 x 720 or higher
- Port for controller communications: Ethernet for F4T or EIA-485 half duplex (2-wire) for EZ-ZONE RM

## Illustrations from COMPOSER for F4T

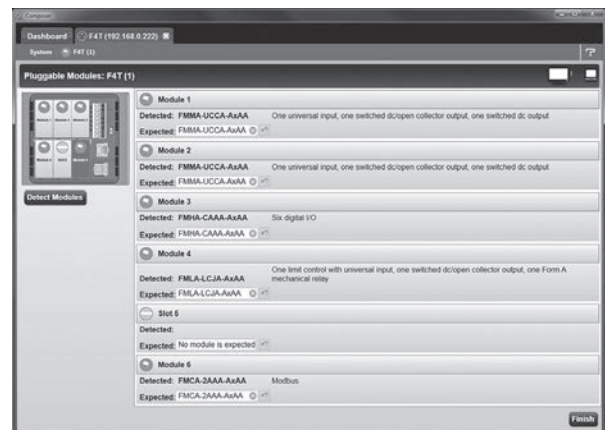

Pluggable modules view simplifies configuration by showing hardware present.

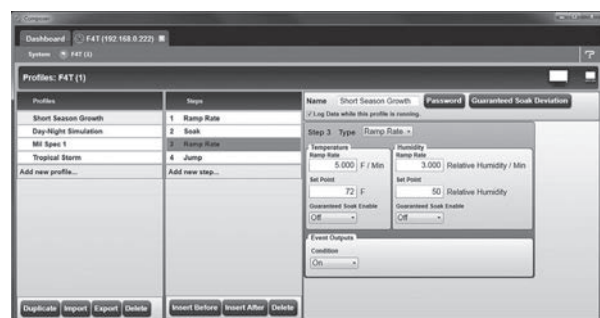

Profile editor speeds up creating and editing profiles.



## EZ-ZONE® Configurator

EZ-ZONE® Configurator software allows Watlow® EZ-ZONE products to be configured in one simple process. Its interface is flexible and easier to read than the basic remote user interface (RUI). It operates without requiring purchase of communications options as it uses the standard bus communications protocol that is included with all EZ-ZONE products.

The EZ-ZONE Configurator software is available as a free download at [www.watlow.com](http://www.watlow.com).

### Features and Benefits

#### Communicates with EZ-ZONE products via standard bus protocol

- Works regardless of which communications option is purchased or even when no communication option is purchased

#### Detects EZ-ZONE devices and reads up configuration

- Allows easy access to any setting

#### Presents pages and menus as they are in the controller's display, RUI and manuals

- Enables the user to easily locate what they are looking for

#### Wizard-style editor with menu explorer

- Allows for easy examination of each menu
- Enables the user to skip directly to the parameters they want to work with

#### On-screen parameter help

- Reduces configuration errors
- Helps the user take full advantage of available features

#### Copies parameter settings

- Decreases configuration time especially for multi-loop controllers

#### Saves configuration files on the computer with all the information required to set up a controller

- Preserves settings to archive and recover or simplify setting up of another EZ-ZONE product
- Enables set up files to be emailed or accessed by users on a network or via the Internet

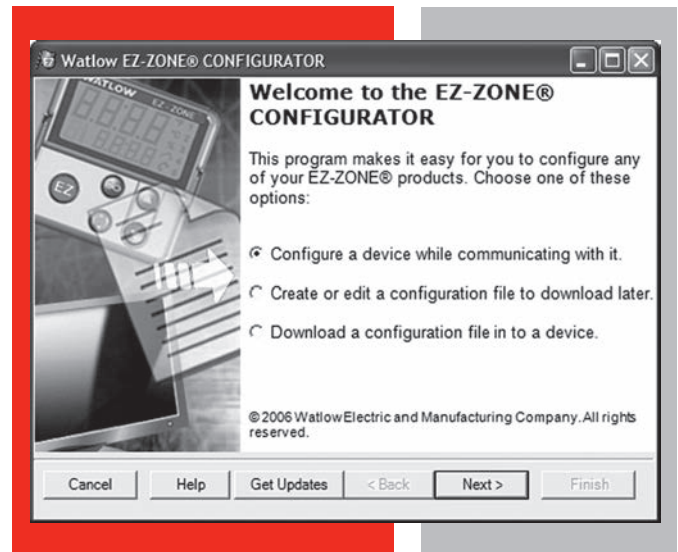

#### View or modify configuration files saved during online editing sessions

- Allows users to get a headstart on setting up EZ-ZONE products
- Aids in supporting remote users

#### Downloads saved configuration files

- Simplifies setting up EZ-ZONE products

#### Flexible and smart compatibility checking

- Ensures configuration files are only loaded in to devices with compatible hardware

## EZ-ZONE Configurator

### Technical Data

### Illustrated Features

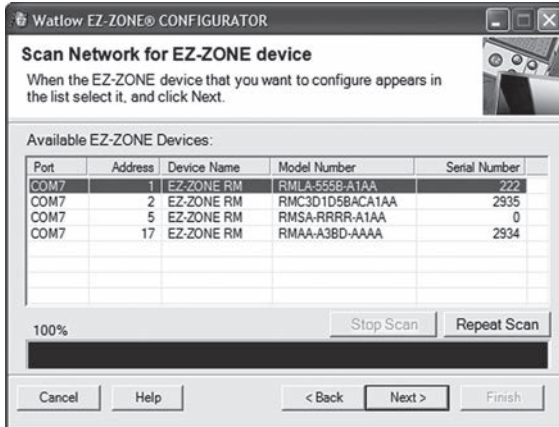

Detects EZ-ZONE devices connected to the computer's communications ports.

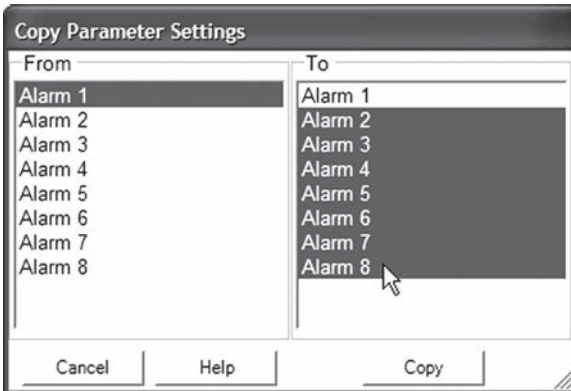

Copy feature speeds up configuration.

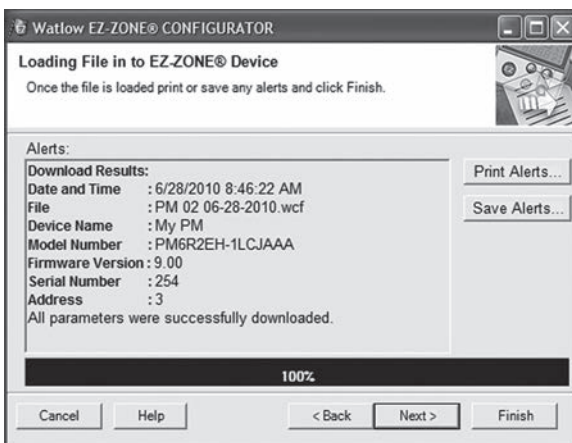

Confirms that parameter downloads were successful and reports exceptions.

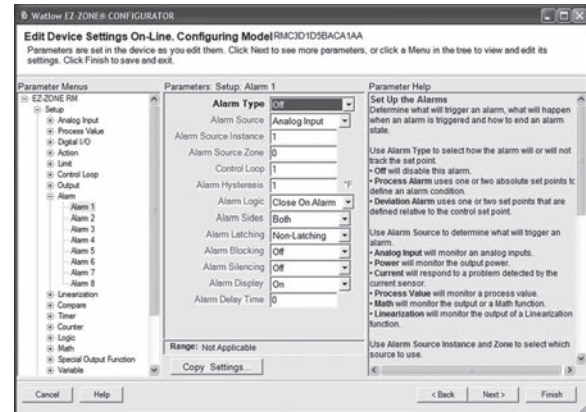

Menu explorer allows users to skip directly to desired parameter or browse each setting.

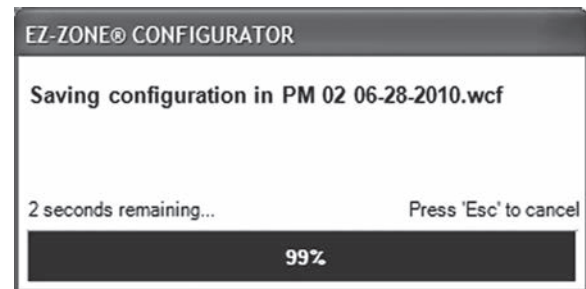

Saves complete sets of parameter settings for backup, archiving or configuring other devices with the same settings.

### Compatibility

EZ-ZONE Configurator software can be used to configure EZ-ZONE products when run on a computer connected to the EZ-ZONE product's standard bus port (EIA-485 also known as RS-485). For most computers a 485 converter is required.

### System Requirements

#### Minimum Requirements

- 485 communications port: USB port and USB-to-485 converter, or serial COM port (232) and 232-to-485 converter
- Microprocessor: Pentium® IV or equivalent
- Memory: 128 MB RAM (256 MB recommended)
- Disk space: 140 MB (100 MB if Microsoft.NET Framework is already installed.)
- Video: 800 x 600 (1024 x 768 or higher recommended)

#### Operating System Requirements

- Windows® 8
- Windows® 7

## EZ-ZONE LabVIEW™ Driver

This instrument driver for National Instruments' LabVIEW™ software communicates with Watlow's EZ-ZONE products via the standard bus communications protocol that is included with all EZ-ZONE products.

The LabVIEW™ instrument driver software package, created with LabVIEW™, simplifies development of applications such as test software. These instrument drivers include software functions called LabVIEW™ Virtual Instruments (VIs) that are used with LabVIEW™ to communicate with Watlow products such as the EZ-ZONE PM.

The EZ-ZONE LabVIEW™ instrument driver software is available as a free download from [www.watlow.com](http://www.watlow.com).

### Features and Benefits

#### Supports access to all EZ-ZONE parameters

- Makes it easy for LabVIEW™ users to use EZ-ZONE products with their programs

#### Compatible with any EZ-ZONE product configured to communicate via standard bus

- Reduces cost by eliminating the need to purchase optional communications protocols

#### Features Initialize, Read, Write and Close VIs

- Speeds development of LabVIEW™ applications

#### Includes a working example with detailed instructions

- Shortens the learning curve associated with applying a new instrument

### Compatibility

The Watlow EZ-ZONE instrument driver is supported by LabVIEW™ versions 8.6 and later.

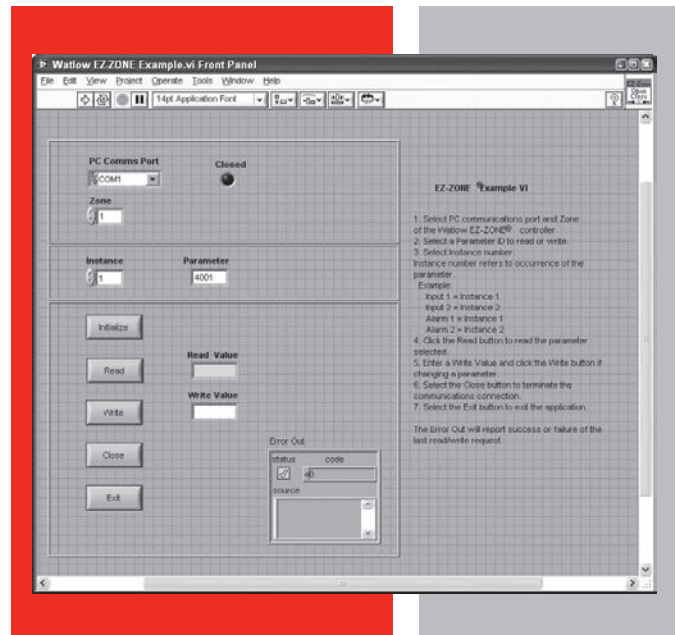

## EZ-ZONE GSD Editor

The EZ-ZONE GSD Editor software allows users to create custom general station description (GSD) files for configuring communications between EZ-ZONE products and other automation equipment supporting the PROFIBUS DP communications protocol.

The EZ-ZONE GSD software is available for download free of charge at [www.watlow.com](http://www.watlow.com) and on the Controller Support Tools DVD-ROM (part number 0601-0001-0000) included with the related Watlow controllers.

### Features and Benefits

#### Creates and edits GSD files

- Enables configuration of DP-V0 (cyclic) communication between EZ-ZONE devices and a PROFIBUS DP master such as a programmable logic controller (PLC)

#### Allows users to select just the values they need

- Optimizes PLC memory use by allowing cyclical messages to be configured with desired data only
- Speeds up network by eliminating the transmission of unnecessary data as with fixed, vendor-supplied GSD files

#### Supports EZ-ZONE PM, RM Access Modules and RUI Gateways

- Makes it easy for PROFIBUS DP users to use EZ-ZONE products in their applications

#### Presents all the parameters found in supported EZ-ZONE device's menus

- Maximizes flexibility in the design of applications

### System Requirements

#### System Requirements:

- Microprocessor: Pentium® IV or equivalent
- Memory: 128 MB RAM (256 MB recommended)
- Disk space: 140 MB (100 MB if Microsoft.NET Framework is already installed.)
- Video: 1024 x 768 or higher
- Microsoft® compatible pointing device (mouse or trackball)

#### Operating System Recommended:

- Windows® 8
- Windows® 7

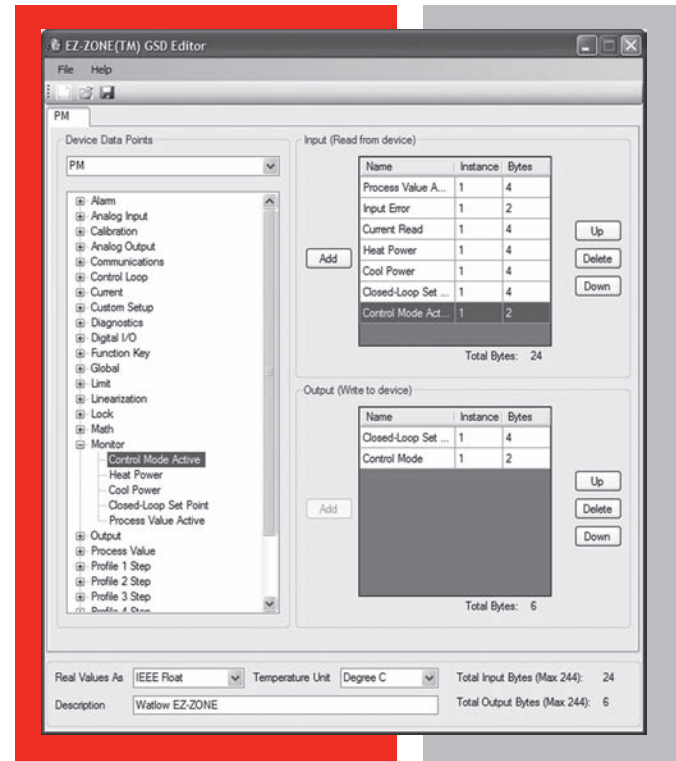

### Compatibility

EZ-ZONE GSD Editor software can be used to create and edit GSD files for EZ-ZONE PM controllers with the PROFIBUS DP field communications option and EZ-ZONE ST and PM controllers and RM control systems when connected to an EZ-ZONE RM access module or EZ-ZONE RUI gateway with the PROFIBUS DP option.

# Software

## EHG® SL10 Software

The EHG® SL10 software allows the user to configure, monitor, log and chart data from Watlow's EHG SL10 integrated multi-function controllers. It provides an easy-to-use and centralized interface for multiple EHG SL10 controllers.

This software gives the user the ability to change set points, label devices and much more all with the click of a key.

The EHG SL10 software is available for download free of charge at [www.watlow.com](http://www.watlow.com) and on the Controller Support Tools DVD-ROM (part number 0601-0001-0000) included with the related Watlow controllers.

### Features and Benefits

#### Automatic network detection and configuration

- Simplifies configuring multi-device networks by setting unique addresses in each device as they are added to the network
- Scans for new controllers added to the network

#### Manual network configuration

- Connects to and monitors existing controller networks

#### User definable device names

- Speeds up troubleshooting by allowing users to set names for networked controllers that correlate them with heater locations

#### Monitor mode

- Displays temperature, and color coded alarms and warnings for all networked controllers
- Centralizes monitor function and eliminates time spent checking alarm states at the heater

#### Network state indicator

- Simplifies and reduces errors when controlling many points
- Shows at a glance if any controller has a warning or alarm condition

#### Charting

- Improves system operation by allowing engineers and operators to see zone temperature trends in real time

#### Data logging

- Saves time and effort by eliminating the need to manually record temperatures
- Simplifies troubleshooting by providing a record of zone temperatures

#### Configure mode

- Simplifies and speeds up changing set points and other control parameters



#### Password protected setup

- Prevents unauthorized changes to alarm set points, tuning and control settings

#### Recipe manager

- Speeds up commissioning new devices by allowing saved recipes to be downloaded to multiple controllers
- Reduces data entry errors by saving known good settings

#### Ping function blinks indicator on selected controller

- Reduces errors by allowing technicians to confirm device identities

### Compatibility

EHG SL10 software can be used to configure EHG SL10 controllers when run on a computer connected to the controllers via an EIA-485 (also known as RS-485) network. For most computers a 485 converter is required.

### System Requirements

#### Operating System

- Windows® XP Professional

## SpecView HMI Software

SpecView software from Watlow® is an easy-to-use Human Machine Interface (HMI) to Watlow controllers, including the F4T with INTUITION process controller and EZ-ZONE controllers as well as third-party products. Watlow's single point of support for hardware, software and application needs ensures knowledgeable and expedient responses to questions or concerns.

This competitively priced package includes field-proven features, many suggested by loyal users. Built-in support and auto-detect for Watlow controllers make setup quick and simple. SpecView from Watlow is ideal for industrial applications with support for barcode readers and touch-screen operation.

To try before purchasing, download SpecView from the Watlow website and run in the time-limited demo mode.

### Features and Benefits

#### Built-in support and auto-detect for controllers

- Saves set-up time
- Eliminates the need to learn communications protocols
- Integrates devices from multiple vendors

#### Watlow EZ-ZONE standard bus communications protocol

- Communicates with any EZ-ZONE product without requiring purchase of a communications option

#### Highly configurable trending/graphing

- Simplifies monitoring and troubleshooting processes and machines
- Provides a permanent, unalterable record of results

#### Flexible data logging and report generator

- Helps users comply with regulatory requirements including AMS 2750D NADCAP
- Reduces labor and increases accuracy by automating data collection
- Simplifies record keeping by consolidating measurements, operator comments and other information into Excel® - compatible report formats
- Allows data to be grouped in user-defined batches
- Records operator actions

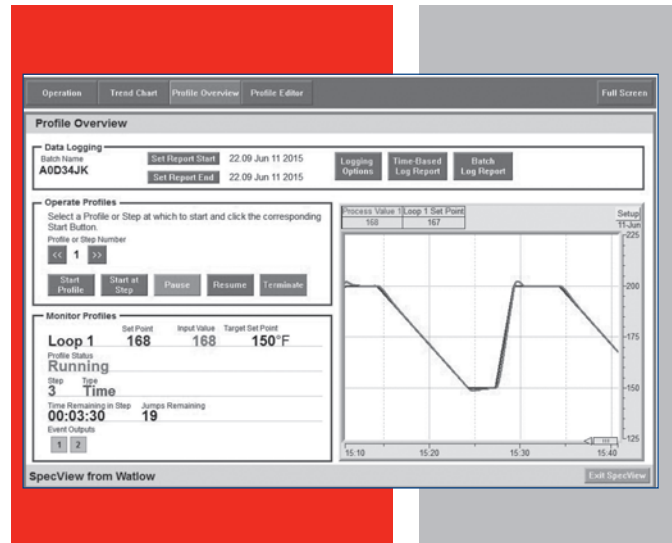

#### Easy-to-build, customizable screens

- Allows creation of application-specific screens, which can automate tasks, decrease training time and simplify monitoring and operation
- Highlights specific parameter values with user-set color dynamics and provides bar graphs for “at-a-glance” monitoring
- Limits access with passwords if desired

#### Easy-to-use recipe manager

- Saves snapshot of current parameter settings
- Eliminates operator error when setting machine parameters
- Reviews and edits complex programmer profiles

#### Historical replay option

- Helps troubleshoot processes by allowing review of recorded data

#### Remote access option

- Allows multiple, identical operator stations for convenient access
- Reduces downtime and increases utilization with monitoring and access over LAN, modem or Internet

**For detailed product and ordering information, see the full SpecView HMI Software product section located on pages 385 through 389.**

# Software

## EZwarePlus

The Silver Series EM programming software, EZwarePlus, is easy to use and features a large variety of built-in screen objects that make it powerful. When creating screens, the user can call upon extensive graphics libraries, import custom graphics and add numeric displays, entry fields, analog meters, bar graphs and trend graphs with just a few mouse clicks. Screen objects are highly customizable, and the user can create libraries of their own objects for repeat use. The online simulator, Ethernet and USB support, make testing and downloading fast.

The EZwarePlus software suite is available for download free of charge at [www.watlow.com](http://www.watlow.com) and on the Controller Support Tools DVD-ROM (part number 0601-0001-0000) included with the related Watlow controllers.

### Features and Benefits

#### Powerful, easy-to-use EZwarePlus programming software

- Requires only a small investment in time to create a useful interface
- Provides the ability to learn additional features as needed
- Provides advanced interface features such as animation and pop-up windows
- Reduces development time by providing extensive graphical libraries and facilitating reuse with user-created libraries

#### Offline and online simulation

- Speeds up development by making it faster and easier to test projects
- Allows faster creation of fine-tuned interfaces by speeding up iterations

#### Upload and download password protection

- Prevents users from altering projects
- Protects projects in OITs from accidental overwrite

#### Extensive graphical libraries and user-created libraries

- Reduces development time and facilitates reuse
- Simplifies development by allowing import of common graphic formats: bitmaps, JPEGs and animated GIFs

#### Project manager

- Simplifies managing projects for multiple applications

#### Project compress/uncompress

- Archives all necessary files in one compressed file
- Allows a single file to be saved or delivered as the project source

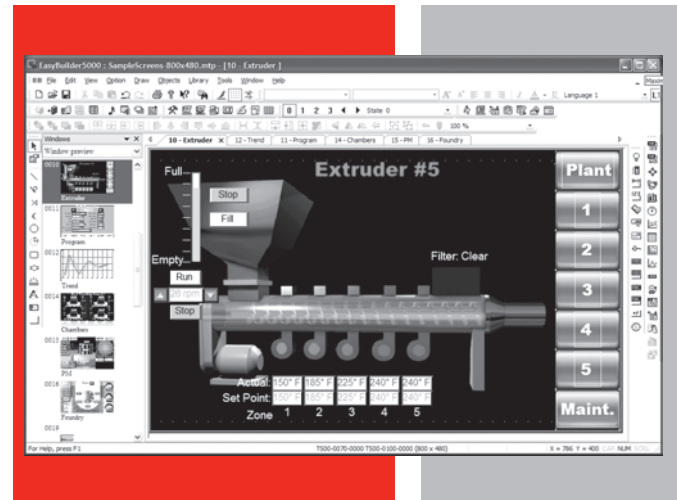

#### User-programmable macros with math functions and support for floating point

- Extends functionality
- Automates processes

#### TrueType fonts with Unicode (international) characters and language switching feature

- Makes screen content easy to read by allowing formatting such as bold, italics, underline, scrolling and blinking
- Prevents errors by communicating with users in their native languages
- Reduces development and support by allowing inclusion of up to 24 user-selectable languages in a project

#### Tag library and address find and replace function

- Simplifies project reuse with similar but not identical controllers

#### Label library

- Speeds up screen development by eliminating the need to enter the same text multiple times
- Enables on-the-fly language changes for up to 24 languages per project

#### Library import and export functions

- Reduces errors and speeds up development by eliminating tedious data entry when multiple projects interface with the same devices

#### Layers, grid, alignment, nudge, space-even and make-same-size tools

- Speeds up creation of smart looking screens by automatically placing objects aligned on the screen
- Gives user precise control over object placement

# Software

## EZwarePlus

### Software Suite

The EZwarePlus software suite includes EasyConverter, EZwarePlus screen editor, Utility Manager and Recipe Editor programs.



Utility Manager uploads and downloads projects to and from the Silver Series EM OIT, opens compiled projects in simulation and launches the other EZwarePlus programs.

ID	ADDRESS	Recipe Name	Set Point 1	High Process Alarm 1	Set Point 2	High Process Alarm 2	Cap
0	0	Standard Process	450.5	500	487	525	
1	19	Spec for Alpha Lab	235	250	215	250	
2	38	Mil Specification	425.1	450	375	425	
3	57	FDA Test	140.3	175	150.7	180	
4	76	CE Test	50	65	75	100	

The Recipe Editor configures memory files for use with Silver Series EM OITs and allows offline creation of recipes.

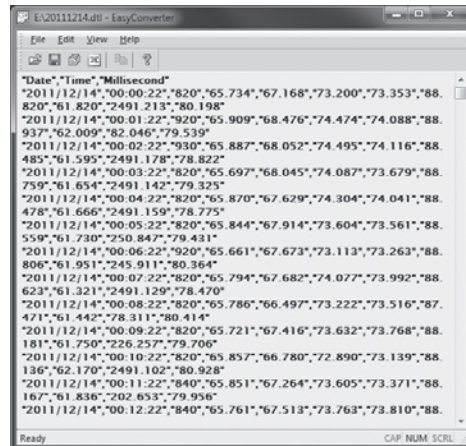

EasyConverter converts log files saved by the Silver Series EM OIT to file formats used by popular Windows® software such as Microsoft® Excel®.

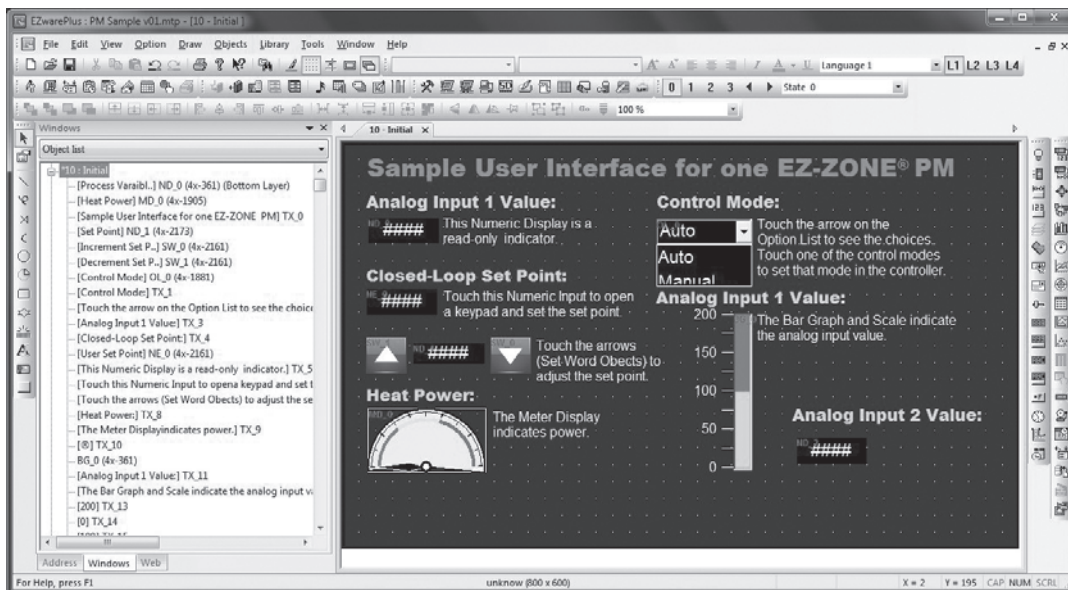

EZwarePlus provides a graphical screen designing environment with point-and-click access to features and drag-and-drop ease.

### Compatibility

EZwarePlus software can be used to configure Silver Series EM operator interface terminals as interfaces for Watlow EZ-ZONE controllers and other automation devices.

**Note:** EZware-5000 is still available for programming older Silver Series OITs.

### System Requirements

#### Operating System

- Windows® 10, 8.1, 8, 7, Vista or XP



## WATVIEW™ HMI Software

**Note: WATVIEW™ is not compatible with Windows® Vista or Windows® 7 and does not support Watlow EZ-ZONE controllers. Please consider SpecView for your HMI software needs.**

WATVIEW is Watlow's Human/Machine Interface (HMI) software for older Watlow controllers. WATVIEW features easy controller setup, recipe and alarm managers, data-logging and trend plot graphing.

WATVIEW is available in three editions:

- **Run-Time Edition**—for operating controllers
- **Developer Edition**—creates custom screens
- **Configurator Edition**—available free of charge for setting up controllers at [www.watlow.com](http://www.watlow.com)

### Features and Benefits

#### Easy program setup

- Scans all available communications ports and baud rates for supported controllers
- Detects which controllers are connected to the computer
- Automatically configures with appropriate setup screens and help files for detected controllers

#### Controller specific setup and spreadsheet overview screens

- Simplify monitoring and adjusting controller parameters
- Display settings for multiple channels and controllers
- Present parameters according to controller's menus

#### Recipe manager

- Stores commonly used controller settings
- Speeds up repetitive controller setups
- Backs up "snapshot" of your settings against data loss

#### Calendar-start function

- Automates processes by downloading recipes automatically in a one-time or repeating schedule

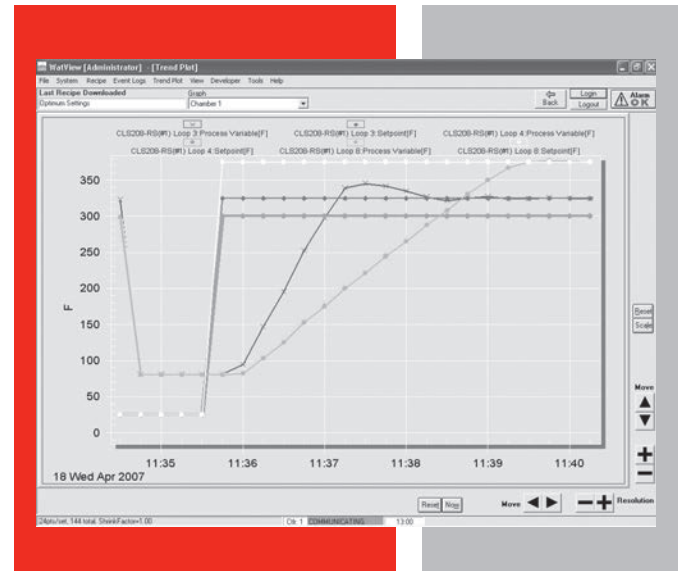

#### Alarm manager

- Makes alarms easier to understand with customizable, plain text messages
- Aids in troubleshooting by time stamping and logging alarms
- Streamlines alarm management by allowing monitoring, acknowledging and clearing alarms for multiple controllers

#### Data-logging and trend plot graphs

- Reduce labor and increase accuracy by automating data collection for the parameters you choose
- Save time by exporting data to Excel®-compatible spreadsheet files
- Simplify process adjustments and troubleshooting by graphing up to 20 data items together on a graph
- Provide flexibility by allowing users to name, save and choose for display from any number of graphs

**For detailed product and ordering information, see the full WATVIEW HMI Software product section located on pages 391 through 392.**



# Accessories

Product	Description	Page
<b>EZ-ZONE® RUI and Gateway</b>	Remote user interface and communications device	<b>409</b>
<b>Serial Converters</b>	Devices that bridge between serial networks	<b>410</b>
<b>Combined Branch and Semiconductor Fuses</b>	Provide required protection for short circuit current rating (SCCR) and meet electrical code for branch circuit protection	<b>412</b>
<b>Semiconductor Fuses</b>	Disconnect power from loads to protect people and property in case of a failure	<b>414</b>
<b>Current Transformers</b>	Detect and measure load currents	<b>415</b>
<b>Panel Mount Adapter Plates</b>	Provide convenient, cost saving way to replace large old controllers with new, modern smaller models in existing control panels	<b>416</b>
<b>Arc Suppression and EMI Filters</b>	Protect controller outputs and reduce noise emissions	<b>416</b>
<b>Power Supplies</b>	UL® Class 2 power supplies for controllers that require DC power	<b>417</b>





# Accessories

## EZ-ZONE® RUI and Gateway

The EZ-ZONE® Remote User Interface (RUI and communications gateway) can be utilized as a communication gateway device to save cost, space and wiring when digital communications is being used with two or more EZ-ZONE controllers. The EZ-ZONE RUI can also serve as a display for showing all parameter values for up to 16 EZ-ZONE controllers, again saving cost, space and wiring expenses.

### Indicator Features and Benefits—Remote User Interface (RUI)

#### Single user interface device or location to access multiple controllers

- Easy accessibility to all controllers and all parameters from a central location by using one RUI display
- Reduces component material costs by using a single RUI to display multiple control zones
- Eliminates cost and complexity from bringing all controller related input and output wiring to the front panel

#### Flexible use of a display interface

- Can be used when needed during normal machine production, for OEM prototype design purposes or for remote troubleshooting scenarios
- Ability to use more than one RUI indicator to display additional data including temperature and current (ammeter) to improve user system interface

### Communications Gateway Features and Benefits

#### A single RUI and gateway provides field bus access for up to 16 EZ-ZONE controllers

- Lowers solution cost when field bus communications is required for multiple loops

#### Expand communication protocols to all EZ-ZONE controllers

- Ability to utilize multiple communication protocols for different user preferences. Flex between different communication protocols while still maintaining a reduced level of inventory



#### Delivers multiple communication protocol options

- Ability to connect EZ-ZONE controllers to communication networks utilizing
  - Modbus® RTU
  - DeviceNet™
  - Ethernet/IP™
  - Modbus® TCP
  - PROFIBUS DP

#### Additional Features

##### EZ-ZONE P3T armor sealing system

- Complies with NEMA 4X, IP65 RUI
- Offers water and dust resistance, can be cleaned and washed down

##### EZ-KEY (RUI)

- Programmable EZ-Key is a functional key programmable by the user to perform simple one-touch operation of repetitive user activities

##### Compact package

- Reduces required panel size for 1/16 DIN
- Utilizes less depth behind panel allowing for mounting in tight spaces

##### Touch-safe package

- Complies with IP2X which increases safety for user

**Agency approvals: UL® listed, CSA, CE, RoHS, W.E.E.E., SEMI F47-0200, Class 1, Div. 2 rating on selected models**

- Meets applications requiring agency approvals

**For detailed product and ordering information, see the full EZ-ZONE RUI and Gateway product section located on pages 371 through 374.**

# Accessories

## Serial Converters

Laptop and personal computers include a variety of features including serial communications “COM” ports and Universal Serial Bus (USB) ports that allow them to communicate with other devices such as printers and digital cameras. Industrial and commercial devices such as process and temperature controllers often have EIA-485 communications interfaces (also known as RS-485) which cannot be directly connected to a typical computer. Watlow offers a series of serial converters that provide a simple and reliable solution to connecting these devices to computers.

These compact serial converters offer several features that make them ideal for use in applications in which Watlow controllers communicate with a computer via Modbus® RTU or EZ-ZONE standard bus.

### Features and Benefits

#### Adapts existing computer port to EIA-485

- Supports using computer software with industrial products
- Eliminates the need to add a serial communications card to the computer

#### USB connection to computer (0847-0326-0000)

- Adds a communications port to a computer with USB
- Automatically configures on Windows® 8, 7, Vista, XP, ME, 2000 and 98
- Eliminates need for external power supply
- Includes cable

#### Screw terminals

- Connects to standard 485 network wiring with no need for additional components

#### Optical isolation (0830-0473-0005)

- Prevents ground loops that can disrupt or damage instruments that are not isolated

#### USB to Ethernet (0847-0400-0000)

- Provides additional local Ethernet network for configuring controllers with Ethernet communications

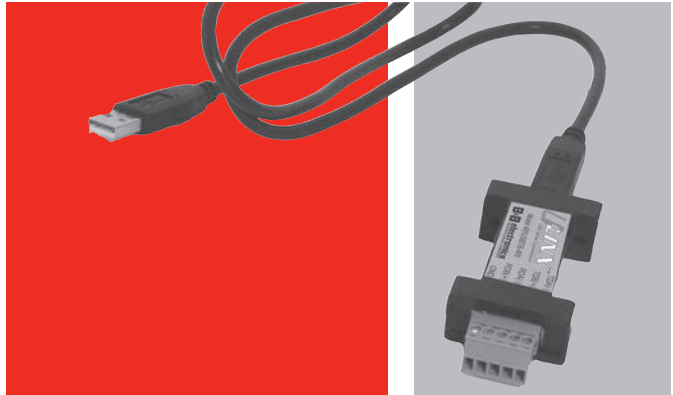

0847-0326-0000  
USB to 485,  
USB to Screw Terminals



0847-0400-0000  
USB to Ethernet, RJ45

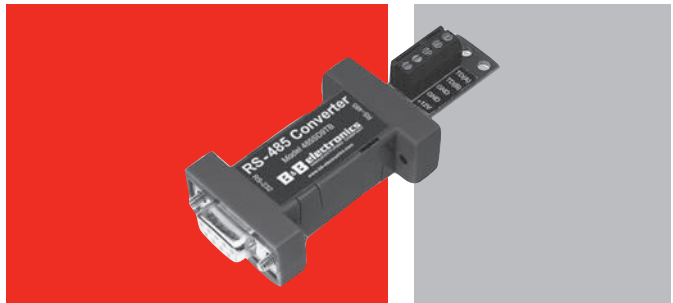

0830-0473-0001  
232 to 485, DB9 Female  
to Screw Terminals

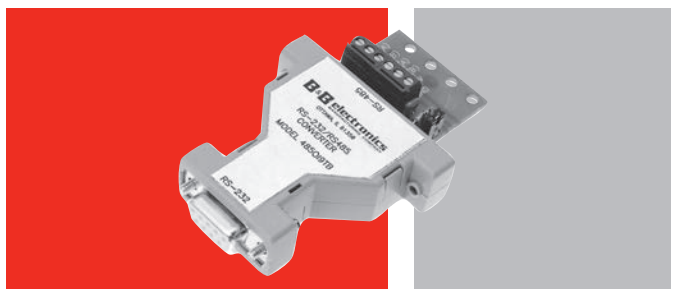

0830-0473-0005  
232 to 485, Isolated,  
DB9 Female to  
Screw Terminals

# Accessories

## Serial Converters

### Specifications

Specification	0847-0326-0000	0847-0400-0000	0830-0473-0001	0830-0473-0005
Connection to computer	USB type A	USB type A	DB-9, female	DB-9, female
Computer interface	USB 1.0, 1.1 and 2.0	USB 1.0, 1.1 and 2.0	Serial COM (232)	Serial COM (232)
Connection to serial network	Removable terminal block	RJ-45 female	Terminal block	Terminal block
Serial network	Half duplex 485 (2-wire)	IEEE 802.3, 802.3u and 802.3ab (10BASE-T, 100BASE-TX and 1000BASE-T) compatible	Half duplex 485 (2-wire)	Full duplex (4-wire) or half duplex 485 (2-wire) <sup>①</sup>
Communication speed	300 to 921K baud	480 Mbps (USB 2.0)	300 to 115.2K baud	300 to 115.2K baud
Echo jumper	No	Crossover detection and auto-correction (Auto MDIX)	No	Yes
Optical isolation: data-to-ground and computer-to-network	None	None	None	1500V RMS 1 minute
Port powered	Yes	Yes	Yes, when computer's handshake lines are powered	232 side requires power from computer's handshake lines
Cable length	39 in. (1 m)	10.6 in. (270 mm)	No cable	No cable
External power supply	Not needed	Not needed	Required for computers without powered handshake lines	Required for 485 side
Agency	CE, RoHS	CE, RoHS	CE, RoHS	CE, RoHS
Supported operating systems	Windows® 8, 7, Vista, XP, ME, 2000 and 98	Windows® 10, 8 / 8.1, 7, Vista, XP	No software required	No software required
Dimensions	2.53 x 1.25 x 0.64 in. (64 x 32 x 16 mm)	10.6 x 1.2 x 0.8 in. (270 x 30 x 20 mm)	3.50 x 1.34 x 0.67 in. (89 x 34 x 17 mm)	3.20 x 2.10 x 0.64 in. (81 x 53 x 16 mm)
Recommended applications	Computer with a USB port, communicating via Modbus® RTU or EZ-ZONE standard bus	Computer with a USB port, communicating via Modbus® TCP or standard bus over Ethernet (F4T)	Computer with a DB-9 male 232 serial port, communicating via Modbus® RTU or EZ-ZONE standard bus	Computer with a DB-9 male 232 serial port, communicating via Modbus® RTU or EZ-ZONE standard bus

<sup>①</sup>Half duplex operation (2-wire) requires connection of -Tx and -Rx and +Tx and +Rx in external cable.

Converters	Description
<b>0847-0326-0000</b>	USB to 485, USB to screw terminals
<b>0847-0400-0000</b>	USB to Ethernet, RJ45 female
<b>0830-0473-0001*</b>	232 to 485, DB9 female to screw terminals
<b>0830-0473-0005*</b>	232 to 485, isolated, DB9 female to screw terminals

Accessories	Description
<b>0830-0473-0003</b>	6-foot serial communications cable, DB9 male to DB9 female
<b>0830-0473-0002</b>	Power supply (110-120VAC input, 12VDC output)
<b>0830-0473-0004</b>	Power supply (210-240VAC input, 12VDC output)

\*The isolated 232 to 485 converter and any 232 to 485 converter used with a computer (particularly a laptop) that does not provide power to the converter, requires a power supply.

# Accessories

## Combined Branch Protection and Semiconductor Fusing

To meet national and local electrical code requirements for branch circuit protection and to protect solid state power controllers, such as Watlow's DIN-A-MITE®, a DFJ fuse is recommended. Watlow offers fast-acting DFJ fuses and holders in amperage ratings covering the range of load currents appropriate for use with the entire DIN-A-MITE power controller and EZ-ZONE ST integrated controller families.

DFJ fuses protect personnel from injury, protect equipment from damage and are required to minimize damage in the event of a short circuit and achieve short circuit current ratings for Watlow DIN-A-MITE power controllers and EZ-ZONE ST controllers.



### Features and Benefits

#### Combination semiconductor and branch circuit protection

- Fulfills electrical code requirements for branch circuit protection
- Provides protection required for short circuit rating (SCCR) of Watlow products up to 200kA
- Protects valuable semiconductor-based power controllers from damage in the event of a shorted heater
- Simplifies cabinet design
- Reduces wiring time
- Reduces the number of components and cost

#### DIN-rail mount

- Ensures easy installation

#### Lockout/tagout

- Protects service personnel

#### Open fuse indicator

- Provides quick troubleshooting of blown fuses



## Combined Branch Protection and Semiconductor Fusing

### Fuse Selection Guide

Use a DFJ fuse to protect both a branch circuit or power cable and the solid state power controller on the circuit with a single fuse.

1. Select a fuse with an amperage rating at least 125 percent of the connected load (or the next standard size above.)
2. Select a fuse with an I<sup>2</sup>t rating not greater than the I<sup>2</sup>t rating of the solid state power controller. See the specification sheet for the power controller to be protected for I<sup>2</sup>t specification. See DFJ fuse I<sup>2</sup>t below.
3. Use a Watlow recommended fuse. SCCR ratings for Watlow power controllers are only valid with Watlow recommended fuses and only up to 480VAC. For applications above 480VAC or products other than DIN-A-MITE or EZ-ZONE ST contact your Watlow representative.

Fuse Amp Rating	I <sup>2</sup> T up to 480V (A <sup>2</sup> Sec)	Watlow Part Number	Bussman <sup>®</sup> Equivalent Fuse Part Number	Watlow Single Fuse Holder Part Number	Bussman <sup>®</sup> Holder Equivalent Part Number	Holder Dimensions (in.)			
						A	B	C	D
20	151	0808-0325-0020	DFJ-20	0808-0326-1530	CH30J1I	1.28	4.59	2.80	2.30
30	414	0808-0325-0030	DFJ-30	0808-0326-1530	CH30J1I	1.28	4.59	2.80	2.30
40	1080	0808-0325-0040	DFJ-40	0808-0326-3560	CH60J1I	1.58	4.88	2.80	2.50
50	2268	0808-0325-0050	DFJ-50	0808-0326-3560	CH60J1I	1.58	4.88	2.80	2.50
60	2909	0808-0325-0060	DFJ-60	0808-0326-3560	CH60J1I	1.58	4.88	2.80	2.50
80	3521	0808-0325-0080	DFJ-80	0808-0326-7010	J60100-1CR	1.95	6.28	2.28	1.5
100	7920	0808-0325-0100	DFJ-100	0808-0326-7010	J60100-1CR	1.95	6.28	2.28	1.5

### Dimensional Drawings

#### 15 to 30 and 35 to 60 Amp Fuse Holders

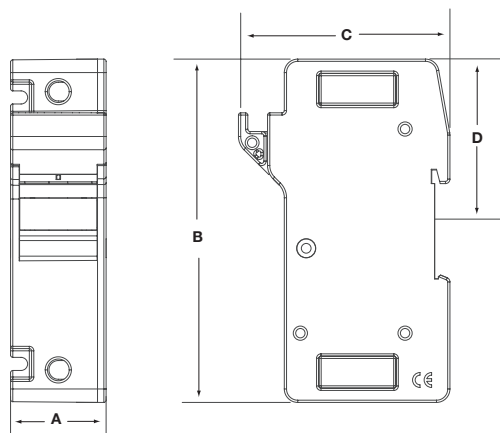

Mounts on 35 mm DIN-rail (DIN EN 50022 35 x 7.5 mm)

#### 80 to 100 Amp Fuse Holder Panel Mount Only

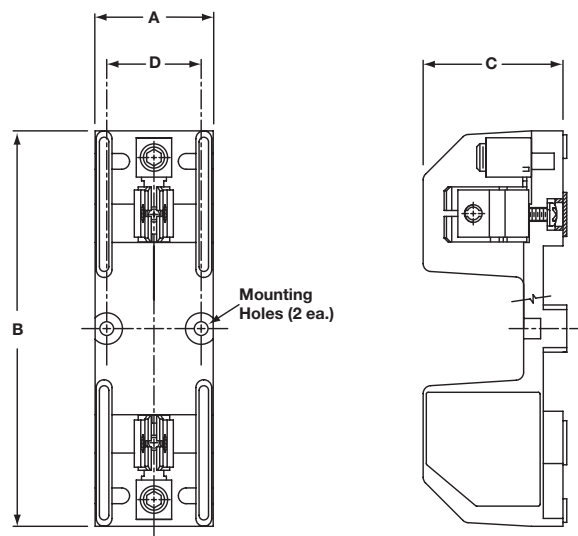

Mounting holes: 0.22 in. (5.5 mm) dia. hole with 0.50 in. (12.7 mm) dia. x 0.27 in. (6.9 mm) deep counter sink bore

# Accessories

## Semiconductor Fuses

For protection of solid state power controllers, such as Watlow's DIN-A-MITE, a semiconductor fuse is recommended to protect the power controller and ensure long life. To safeguard power controllers, Watlow offers DIN-rail mount fuse holders and semiconductor fuses in various sizes to accommodate the entire DIN-A-MITE SCR power controller family and solid state relay products. These fuse holders feature lockout/tagout and open fuse indication.

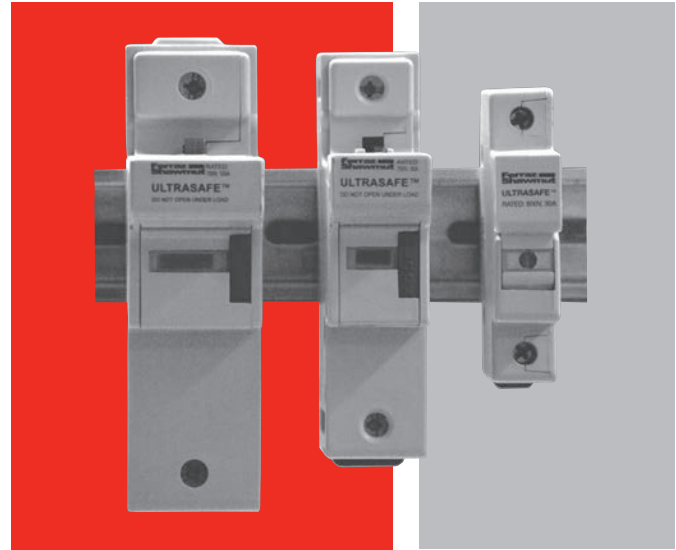

Fuse						Fuse Holder	
Amp Rating	I <sup>2</sup> T (A <sup>2</sup> Sec)	Part Number	Dim. A mm	Dim. B mm	Weight gm	Part Number	Weight gm
12	120	17-8012	10	38.1	9.2	17-5110	53.8
20	260	17-8020	10	38.1	9.2	17-5110	53.8
25	390	17-8025	10	38.1	9.2	17-5110	53.8
32	150	17-8030	14	50.8	21.0	17-5114	119.4
40	980	17-8040	14	50.8	21.0	17-5114	119.4
50	1800	17-8050	14	50.8	21.0	17-5114	119.4
63	2700	17-8063	22	58.0	53.1	17-5122	229.4
80	5100	17-8080	22	58.0	53.4	17-5122	229.4
100	10,000	17-8100	22	58.0	53.4	17-5122	229.4

**Note:** All fuses should be rated at 125 percent of connected load or the next standard fuse size above 125 percent. Due to special cases such as cooler ambient or lower amperage loads, the connected load should be the determining factor. The semiconductor fuse I<sup>2</sup>t rating must not exceed the SCR I<sup>2</sup>t rating. These fuses are classified as supplemental protection for semiconductor devices. They are not approved for branch circuit protection.

### Fuse and Fuse Holders

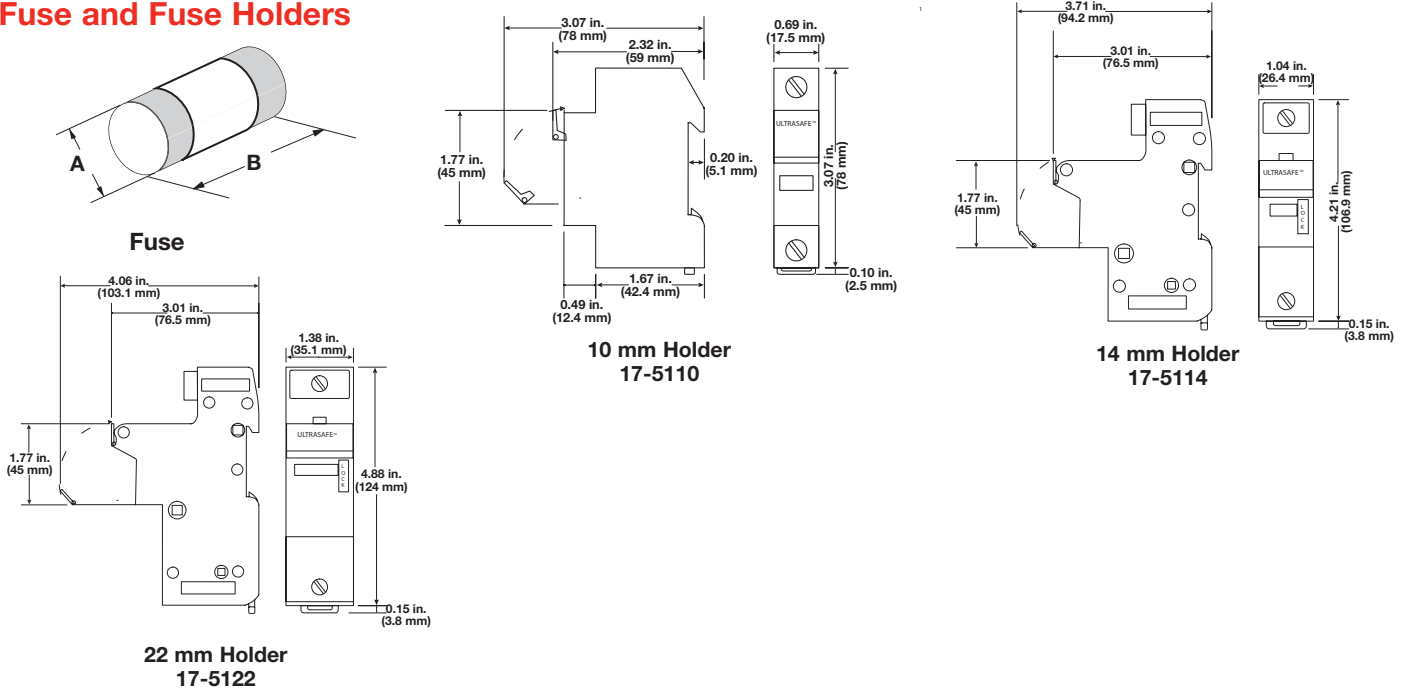

## Current Transformers

A current transformer (CT) provides a signal that is proportional to and isolated from the load that passes through it. The signal from the CT can be measured by a temperature or power controller. The value from that measurement may be used to trigger an alarm, detect an open heater or a shorted SSR, or to indicate the current. Choose the model that provides a measurable output for the planned load current.

To order, simply identify the desired part number. Contact your Watlow representative for availability.

Part No.	Current Ratio
<b>Current Transformer</b>	
<b>16-0246</b> <sup>①</sup>	50 amp: 50mA
<b>16-0008</b> <sup>②</sup>	75 amp: 5 amp
<b>16-0044</b>	100 amp: 5 amp
<b>16-0072</b>	125 amp: 5 amp
<b>16-0008</b>	150 amp: 5 amp
<b>16-0045</b>	200 amp: 5 amp
<b>16-0073</b>	300 amp: 5 amp
<b>0004-0286-0400</b>	400 amp: 5 amp
<b>0004-0286-0500</b>	500 amp: 5 amp
<b>0004-0286-0600</b>	600 amp: 5 amp
<b>0004-0286-0800</b>	800 amp: 5 amp
<b>0004-0286-1000</b>	1000 amp: 5 amp
<b>Interstage Transformer</b>	
<b>16-0176</b>	5 amp: 20mA

**Note:** An interstage transformer (part no. 16-0176) is required with any current transformer rated 75 amps or above.

<sup>①</sup> Supercedes part numbers 16-0230, 16-0231, 16-0232, 16-0233.

<sup>②</sup> Use 2-wire passes through the current transformer 16-0008 for 75 amp applications.

# Accessories

## Panel Mount Adapter Plates

Panel mount adapter plates provide a convenient, cost saving solution to modify existing control panels. Available in a variety of DIN sizes, adapter plates make changing out old, larger size temperature controllers with more sophisticated, compact controllers easy. Simply complete the build-a-part with the specifications you require.

### Ordering Information

#### Part Number

① ② ③ ④	⑤	⑥ ⑦ ⑧	⑨ ⑩ ⑪	⑫
<b>0216</b>	<b>0</b>	<b>Adapter Plate &amp; Config.</b>	<b>P00</b>	<b>Finish</b>

#### ⑥ ⑦ ⑧ Adapter Plate Size and Configuration

920 =	1/2 DIN to 1/4 DIN
865 =	1/4 DIN to 1/8 DIN
866 =	1/4 DIN to 1/16 DIN
895 =	1/4 DIN to 1/32 DIN
867 =	1/8 DIN to 1/16 DIN
897* =	Vertical 1/8 DIN to horizontal 1/32 DIN
899* =	Horizontal 1/8 DIN to horizontal 1/32 DIN
900 =	1/16 DIN to 1/32 DIN

\* Available in black anodized only

#### ⑫ Finish

2 =	Black anodize
3 =	Stainless steel

## Arc Suppression and EMI Filters

### Noise Suppression Devices

These devices protect controller outputs from damage that can be caused by voltage spikes from inductive loads.

Part No.	Description
<b>0802-0273-0000</b>	MOV, 150VAC, 20 joule
<b>0802-0266-0000</b>	MOV, 275VAC, 15 joule
<b>0804-0147-0000</b>	Quencharc®(250VAC max.)

### CE Filters for DIN-A-MITE Products

These filters are required for DIN-A-MITE power controllers to conform with CE conducted emissions standards.

Part No.	Description	Stocked
<b>14-0019</b>	Single-phase, parallel connected filter	Yes
<b>14-0020</b>	Three-phase, parallel connected filter	Yes

# Accessories

## Power Supplies

Watlow's series of Class 2, low-profile DIN rail-mount power supplies, only 2.2 inches deep, are ideal for shallow enclosure installations commonly used in building automation and security applications.

The DSP series supplies are available with nominal outputs from 20 to 28 volts and power levels ranging from 31 to 91 watts in three package sizes. Load regulation is less than 1 percent from no load to full load, with ripple and noise below 50 millivolts. To compensate for cable voltage drops, output voltage can be adjusted from the front panel and colored LED indicators immediately confirm the output status.

### Features and Benefits

#### Low 2.2 inch profile

- Fits into wall-mounted cabinets

#### Wide range AC

- Enables global use with no input selector switches

#### Convection cooled

- Eliminates the need for a system fan

#### Class II double insulation

- Offers impeccable protection

#### DIN-rail or chassis mount

- Adapts easily to different mounting configurations

#### Adjustable voltage output

- Fine tune output voltage from 24 to 28VDC



# Accessories

## Power Supplies

Items/Model Number	DSP30	DSP60	DSP100
<b>Watlow Part Number</b>	<b>0847-0299-0000</b>	<b>0847-0300-0000</b>	<b>0847-0301-0000</b>
<b>AC Input Voltage Range</b>	90-264VAC, Class II double insulated (no ground connection required)	Same	Same
<b>Input Frequency</b>	47-63Hz	Same	Same
<b>DC Input Voltage Range</b>	120-370VDC	Same	Same
<b>Inrush current (115/230VAC)</b>	25/50A	30/60A	30/60A
<b>Power Factor and Flicker</b>	Meets EN 61000-3-2, EN 61000-3-3	Same	Same
<b>Output Voltage</b>	24V	Same	Same
<b>Voltage Adjust</b>	24-28V	Same	Same
<b>Current</b>	1.30A	2.50A	4.20A
<b>Power</b>	31.2 W	60.0 W	100.8 W
<b>Typical Efficiency</b>	83%	86%	85%
<b>Hold Up Time (115VAC)</b>	25ms	12ms	10ms
<b>UL® 1310 Class 2</b>	Yes	Yes	—
<b>Output Voltage Accuracy</b>	±1% of nominal	Same	Same
<b>Line Regulation</b>	1%	Same	Same
<b>Load Regulation</b>	1%	Same	Same
<b>Ripple and Noise (20MHz BW) mV</b>	50mV	Same	Same
<b>Overcurrent</b>	110-160%, fold	Same	Same
<b>Protection (Type)</b>	Forward under short circuit (DSP100-24/C2 102-108)	Same	Same
<b>Overvoltage Protection (Volts)</b>	120-145%	Same	Same
<b>Hold Up Time (115VAC input)</b>	See model selector	Same	Same
<b>LED Indicators</b>	Green LED = On, Red LED = DC output low	Same	Same
<b>Operating Temperature</b>	-25 to +71°C (derate linearly 2.5%/°C from 55 to 71°C)	Same	Same
<b>Temperature Coefficient</b>	±0.02%/°C	Same	Same
<b>Operating Humidity</b>	20 – 95% RH (non condensing)	Same	Same
<b>Cooling</b>	Convection	Same	Same
<b>Withstand Voltage</b>	Input to output 3kVAC for 1 min.	Same	Same
<b>Isolation Resistance</b>	>100M at 25°C & 70% RH, output to ground 500VDC	Same	Same
<b>Vibration (Operating)</b>	IEC 60068-2-6 (Mounting by rail: random wave, 10-500 Hz, 2G, ea. along X, Y, Z axes 10 min/cycle, 60 min.)	Same	Same
<b>Shock (Operating)</b>	IEC 60068-2-27 (Half sine wave, 4G, 22ms, 3 axes, 6 faces, 3 times for each face)	Same	Same
<b>Safety Agency Approvals</b>	UL®1310 Class 2, UL®60950-1, CE	Same	Same
<b>Immunity</b>	EN 61000-4-2, -3, -4, -5, -6, -8 and -11	Same	Same
<b>Conducted and Radiated EMI</b>	DSP10: EN 55022 Class B; DSP30-100: EN 55022 Class A	Same	Same
<b>Weight (Typ) g</b>	200	250	320
<b>Size (W x H x D) in.</b>	2.09 x 3.58 x 2.19	2.8 x 3.58 x 2.19	3.54 x 3.58 x 2.19
<b>Case Material</b>	Plastic	Same	Same
<b>Warranty Years</b>	2	Same	Same

# Accessories

## Power Supplies

### Dimensional Drawings

DSP30

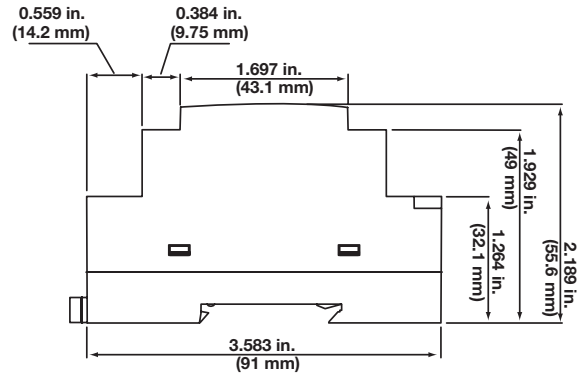
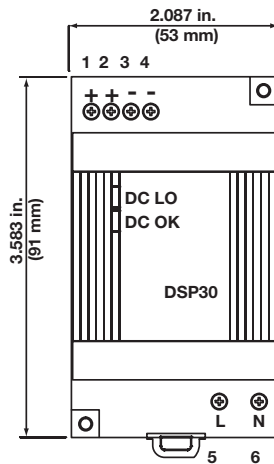

DSP60

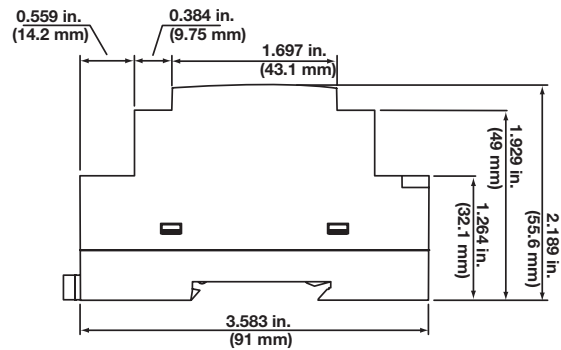
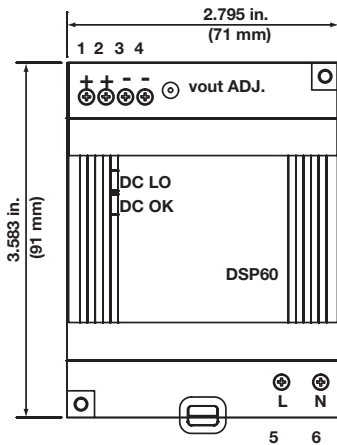

DSP100

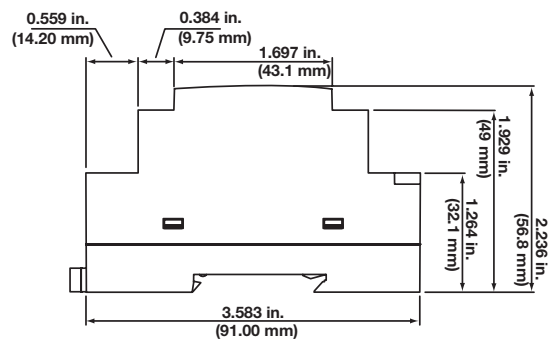
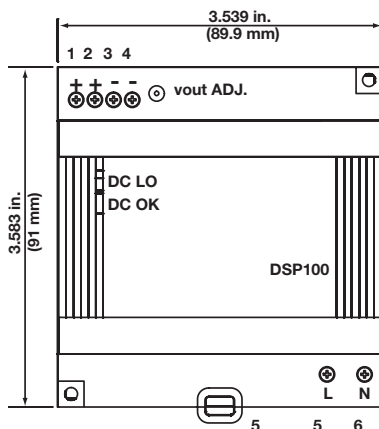





# Control Panels

Product	Description	Supported Controllers	Operating Environment	Page
<b>Control Panels</b>	Control panels designed to link with Watlow immersion and circulation heaters	EZ-ZONE® controllers	32 to 95°F (0 to 35°C)	<b>423</b>

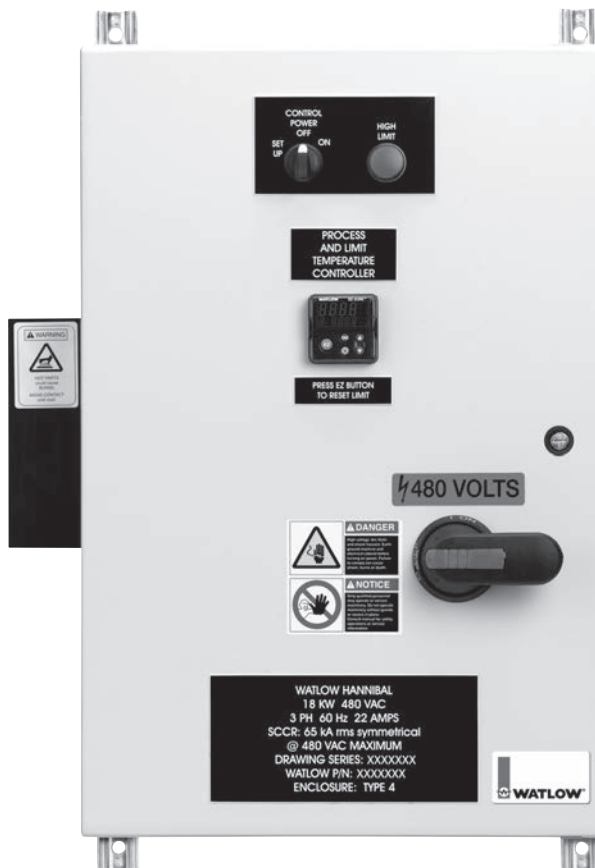

Control Panels



# Control Panels

Proper controller schematic and panel design goes a long way toward ensuring the trouble-free operation of a process system. Watlow® has supplied UL® 508 control panels for a variety of process control applications.

Watlow offers control panels that are shipped within 10 working days of order placement. These panels can drive up to 480VAC, three-phase, 120kW heating systems and are Type 4 rated enclosures that carry the cULus mark. Component installation and wiring conform to applicable NEC and/or CEC standards.

## Performance Capabilities

### Amperage

- Up to 144 amperes

### Voltage

- 120/240VAC single phase
- 208/240/480VAC 3 phase

### Operating Environment

- 32 to 95°F (0 to 35°C)

## Features and Benefits

### Main Disconnect Switch

- Utilizes a rotary handle with interlocking door
- Helps assure maximum operator safety

### Safety Contactor

- Enables the definite purpose break of power
- Prevents abnormal condition failure utilizing an over temperature shutdown

### Enclosure

- Built with Type 4 steel enclosures with gray paint
- Designed with rugged construction suitable for industrial and commercial locations
- Suitable for indoor or outdoor installation in non-hazardous locations

### Branch Circuit Fusing

- Assures compliance with NEC and CEC electrical codes
- Increases SCCR rating
- Reduces risk of over-current related failures and hazards

### SCCR Rating

- Assures compliance with Article 409 of the NEC and UL® 508A



## UL® 508A Agency Certification

- cULus assures compliance with appropriate United States and Canadian codes
- Assures prompt product acceptance
- Reduces end product documentation costs

## Customer Field Connections

- Dedicated terminals for supply, load and control interlock for fast and easy customer connection
- Dedicated terminals for sensor connection with matched alloys where applicable

# Control Panels

## Supported Controllers and Devices

### Watlow EZ-ZONE® Integrated Controllers

- Three-year warranty assures Control Confidence™
- Allows integrated PID and limit control
- Decreases required panel space
- Enables use of laptop for programming setup
- Increases user and equipment safety for over and under temperature conditions
- Reduces the component count
- Utilizes TRU-TUNE® adaptive control

### Watlow DIN-A-MITE® Power Controllers

- One- and three-phase power permits use in a variety of applications
- Faster switching with solid state components. Better control saves energy and extends heater life.
- Back-to-back SCR design for increased durability
- Three-year warranty assures Control Confidence
- Accurate and tight set point control

### Pilot Devices

- High limit pilot light assures quick indication of limit condition
- Three position illuminated ON-OFF-SETUP selector switch assures rapid and accurate operator interface

### Documentation

- Complete wiring schematic and outline drawing
- Factory acceptance test
- I O & M manual

### Supports Communication through EZ-ZONE® or SpecView Using USB Cable and USB to Serial Device

- Standard external bus connection allows easy connection to laptop for programming
- A time-limited trial version of SpecView is available free of charge at [www.watlow.com](http://www.watlow.com).

## Specifications

### Voltage

- 120/240 single phase
- 208/240/480 three phase
- 120 control circuit

### Amperage

- 144 amps max.
- 48 amps per branch circuit max.
- 3 branch circuits max.

### Interrupt Rating

- 50,000 SCCR min.

### Sensor Input

- ANSI Type J or K

### Environmental

- Storage Temperature: 32° to 104°F (0° to 40°C)
- Relative Humidity: 10% to 90% (non-condensing)
- Ratings: Type 4
- Agency: UL® 508A

### Mechanical

- Conduit entry: designed for bottom entry of supply, load and control
- Enclosure wall: blank for customer installations of conduit
- Dimensions: see part number chart on following page

## Dimensional Drawing

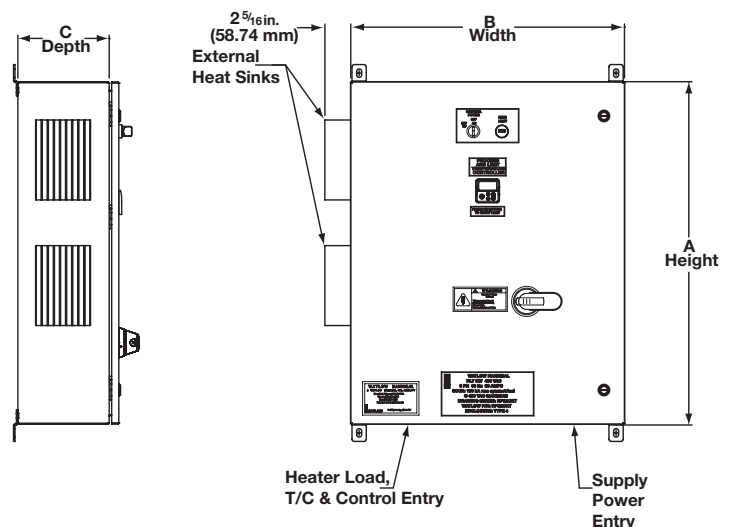

# Control Panels

## Standard Control Panels

### Ordering Information

#### Part Number

① ② Control Panel CP	③ ④ ⑤ ⑥ Process and/or Hi-Limit Control	⑦ Opt. Process & Hi-Limit Sensor	⑧ ⑨ ⑩ ⑪ Part Number
----------------------------	--------------------------------------------	-------------------------------------	------------------------

① ② Control Panel	CP = DIN-A-MITE C power controller
----------------------	------------------------------------

③ ④ ⑤ ⑥ Process and/or Hi-Limit Control	EZPR = EZ-ZONE PM process controller only EZPL = EZ-ZONE PM process and hi-limit controller
--------------------------------------------	------------------------------------------------------------------------------------------------

⑦ Optional Process and Hi-Limit Sensors	J = Type J Input K = Type K Input
--------------------------------------------	--------------------------------------

⑧ ⑨ ⑩ ⑪ Part Number	See chart below for Part number
------------------------	---------------------------------

#### Catalog part numbers include the following features:

- Type 4 enclosure (carbon steel with gray paint)
- Control transformer
- Fused disconnect switch
- Control and load fusing (feed and branch circuit)
- Three position lighted selector switch (on, off, control power only)
- Pilot light (EZPL models only)
- High limit
- Through-wall bus communications input (standard bus with 485)
- Load power, remote interlock and sensor terminal blocks

#### Part Number Chart (Choose part number for Ordering Information 8, 9, 10 and 11 above.)

Nominal Volts	Max. Heater kW	Phase	Circuits	Branch* Circuit Max. Amps	A x B x C ** Enclosure Size in.	Est. Shipping Weight (lbs)	Part Number
208	8.6	3	1	24	16 x 16 x 8	110	<b>2312</b>
208	17.3	3	2	24	36 x 24 x 8	220	<b>2322</b>
208	25.9	3	3	24	36 x 30 x 8	290	<b>2332</b>
240	10.0	3	1	24	16 x 16 x 8	110	<b>3312</b>
240	19.9	3	2	24	36 x 24 x 8	220	<b>3322</b>
240	29.9	3	3	24	36 x 30 x 8	290	<b>3332</b>
480	19.9	3	1	24	16 x 16 x 8	110	<b>4312</b>
480	39.9	3	2	24	36 x 24 x 8	220	<b>4322</b>
480	59.8	3	3	24	36 x 30 x 8	290	<b>4332</b>
208	17.3	3	1	48	24 x 20 x 8	160	<b>2314</b>
208	34.5	3	2	48	36 x 36 x 8	330	<b>2324</b>
208	51.8	3	3	48	42 x 36 x 12	400	<b>2334</b>
240	19.9	3	1	48	24 x 20 x 8	160	<b>3314</b>
240	39.9	3	2	48	36 x 36 x 8	330	<b>3324</b>
240	59.8	3	3	48	42 x 36 x 12	400	<b>3334</b>
480	39.9	3	1	48	24 x 20 x 8	160	<b>4314</b>
480	79.7	3	2	48	36 x 36 x 8	330	<b>4324</b>
480	119.6	3	3	48	42 x 36 x 12	400	<b>4334</b>
120	2.9	1	1	24	16 x 16 x 8	110	<b>1112</b>
240	5.8	1	1	24	16 x 16 x 8	110	<b>3112</b>
240	11.5	1	2	24	36 x 24 x 8	220	<b>3122</b>
240	17.3	1	3	24	36 x 30 x 8	290	<b>3132</b>
120	5.8	1	1	48	24 x 20 x 8	160	<b>1114</b>
240	11.5	1	1	48	24 x 20 x 8	160	<b>3114</b>
240	23.0	1	2	48	36 x 24 x 8	230	<b>3124</b>
240	34.6	1	3	48	42 x 36 x 12	400	<b>3134</b>

\* 24 amp circuits fused at 30 amps  
48 amp circuits fused at 60 amps  
Installation must comply to local electrical codes

\*\* Add 2<sup>5</sup>/<sub>16</sub> inch to "C" dimension for external heat sink



# Part Number Index

## How To Use This Index

This easy-to-use cross reference contains the alpha or numeric prefixes for all Watlow® product part numbers contained in this catalog. The spaces ( ) shown in some of the following prefixes indicate additional characters.

Part Number	Description	Page Number
0004-0286_	Current Transformers	351, 415
0216_	Panel Mount Adapter Plates	416
0219-037_	Silver Series – Splitter Adapter and Communication Cables	370
0219-0382_	Silver Series – USB Cables	370
0219-0388_	Silver Series – Communication Cables	370
080_	Noise Suppression Devices	416
0802-0266_	MOV, 275VAC, 15 Joule	416
0802-0273_	MOV, 150VAC, 20 Joule	416
0804-0147_	QUENCHARC® (250VAC max.)	416
0808-0096_	DIN-A-MITE® D - Replacement Semiconductor Fuses	342
0808-0102_	POWER SERIES™ – Replacement Fuses	347
0830-0473-0001	Serial Convertor – EIA232 to EIA485 Non-isolated, DB9 to Screw Terminals	411
0830-0473-0002	Serial Convertor – Power Supply (110VDC to 120VAC input to 12VDC output)	411
0830-0473-0003	Serial Convertor – 6-foot Communications Cables	411
0830-0473-0004	Serial Convertor – Power Supply (210 to 240VAC input to 12VDC output)	411
0830-0473-0005	Serial Convertor – EIA232 to EIA485 Isolated, DB9 to Screw Terminals	411
0830-07_	Silver Series – Protective Screen Covers	370
0830-0750_	Silver Series – Power Supply	370
0847-0299_	Power Supply	239, 370, 418
0847-030_	Power Supply	239, 418
0847-0326_	Serial Convertor – USB to EIA485 with Screw Terminals	411
08-5362	QPAC - Manual Control Kit	351
104_	Hexoloy® SA(R) Tubes	124
10D_	Adjustable Spring Thermocouple, 6 in. Spring	34
110_	Coated Protection Tubes	123
114_	Ceramic Alumina Protection Tubes	122
115_	Ceramic Mullite Protection Tubes	122
11D_	Adjustable Spring Thermocouple, 12 in. Spring	34
12D_	Adjustable Armor Thermocouple	35
14_	Base Metal Thermocouple, Type K	68, 69
14-00_	DIN-A-MITE – CE Filters	416
1409_	Base Metal Standard Thermocouple with Protection,	69
1414_	Base Metal Standard Thermocouple with Protection, 90° Angle Type	70
1415_	Base Metal Standard Thermocouple with Protection, 90° Angle Type	70
1440_	Base Metal Thermocouple, Angle Type with Two-Hole Insulators	68
15_	Base Metal Thermocouple, Type J	69
16_	Current Transformers	415
17-5_	Fuse Holders	330, 333
17-8_	Fuses	338, 414
20_	Rigid Sheath Thermocouple, Straight	36

# Part Number Index

Part Number	Description	Page Number
21_	Rigid Sheath Thermocouple, 90° Bend	36
2110_	Noble Metal Bare Thermocouples	72
2114_	Noble Metal Thermocouples with Alumina Insulator	72
214_	Noble Metal Thermocouple Assemblies	73
22_	Rigid Sheath Thermocouple, 90° Bend	36
23_	Rigid Sheath with Threaded Fitting Thermocouple, 1/8 in.	37
24_	Rigid Sheath with Threaded Fitting Thermocouple, 3/16 in.	37
25_	Flange Thermocouples	38
265_	SERIES EHG® SL10 Controllers	265
30_	1/16 in. Rigid Sheath Thermocouple, Straight	39
31_	1/16 in. Rigid Sheath Thermocouple, 45° Bend	39
32_	1/16 in. Rigid Sheath Thermocouple, 90° Bend	39
40_	Large Diameter Rigid Sheath Thermocouple, Straight	40
401_	XACTPAK® Cable, Alloy 600	192
402_	XACTPAK Cable, 304 SS	192
404_	XACTPAK Cable, 316 SS	192
41_	Large Diameter Rigid Sheath Thermocouple, Straight	40
418_	XACTPAK Mineral Insulated Cable, Hastelloy® X	194
42_	Large Diameter Rigid Sheath Thermocouple, Straight	40
425_	XACTPAK Mineral Insulated Cable, Inconel® 625	194
4201_	Barrier Type Terminal Strip	132
432_	XACTPAK Mineral Insulated Cable, Haynes® 230	194
505_	Terminal Blocks	132
5750_	SERIES 5750 Transmitters	136
59_	SERIES 5900 Transmitters	139
60_	Flexible Extensions Thermocouples	41
61_	SERIES 61 Insulated Wire Thermocouples	42
62_	SERIES 62 Insulated Wire Thermocouples	42
6556_	Adjustable Spring-Loaded Hex Fitting	112
65D_	PFA Encapsulated Thermocouple, 3/16 in. Diameter	43
65E_	PFA Encapsulated Thermocouple, 1/4 in. Diameter	43
709_	Standard Thermocouple Connection Heads	132
70X_	Ring Terminal Thermocouples	44
71_	Nozzle Thermocouples	45
713	Grommets	129
72_	Pipe Clamp Thermocouples	46
73_	Grommet Thermocouples	47
74_	Brass Shim Thermocouples	48
75_	Stainless Steel Shim Thermocouples	49
807_	Three-Pole Connectors, Cable Clamp	128
90_	Pipe Clamp with Bayonet Adapter Fittings	114
91_	High-Temperature Connector, Ceramic	128
92_	High-Temperature Connector, Adapter for Plug or Jack	128
943_	Weather Resistant Boots	127
AB_	Cut and Stripped Thermocouples	56



# Part Number Index

Part Number	Description	Page Number
<b>AC_</b>	Plug or Jack Termination Thermocouples	57
<b>AF_</b>	Metal Transitions with Spring Strain Relief Thermocouples	59
<b>AQ_</b>	Miniature Transitions Thermocouples	60
<b>AR_</b>	Connection Heads Thermocouples	61
<b>AS_</b>	Wafer Head Thermocouples	62
<b>AT_</b>	For Use with Thermowells Thermocouples	63
<b>AW_</b>	Multipoint Sensor Thermocouples	86
<b>CF_</b>	SERIES CF Controllers	293
<b>CV_</b>	SERIES CV Controllers	290
<b>CZ_</b>	SERIES CZR Power Switching Devices	358
<b>DA_</b>	DIN-A-MITE A Power Switching Devices	330
<b>DB_</b>	DIN-A-MITE B Power Switching Devices	333
<b>DC_</b>	DIN-A-MITE C Power Switching Devices	339
<b>DD_</b>	DIN-A-MITE D Power Switching Devices	342
<b>E_ _ 304</b>	Fiberglass Braided Thermocouple and Extension Wire SERIES 304, Type E	153
<b>E_ _ 305</b>	Fiberglass Wrapped Thermocouple and Extension Wire SERIES 305, Type E	155
<b>E_ _ 502</b>	PVC Insulated Extension Wire SERIES 502, Type E	161
<b>E_ _ 506</b>	Small Gauge FEP Insulated SERIES 506, Type E	163
<b>E_ _ 507</b>	FEP Insulated Thermocouple and Extension Wire SERIES 507, Type E	165
<b>E_ _ 508</b>	TFE Insulated SERIES 508, Type E	167
<b>E_ _ 509</b>	FEP Insulated and Shielded Thermocouple and Extension Wire SERIES 509, Type E	169
<b>E_ _ 510</b>	PVC Insulated and Shielded Thermocouple and Extension Wire SERIES 510, Type E	171
<b>E_ _ 512</b>	Polyimide Insulated SERIES 512, Type E	175
<b>E_ _ 516</b>	PFA Insulated Thermocouple and Extension Wire SERIES 516, Type E	177
<b>ES2_</b>	E-SAFE II Power Switching Devices	355
<b>EZK_</b>	EZ-ZONE® RUI and Gateway	374
<b>F4D_</b>	SERIES F4 Dual Channel Ramping Controllers	280
<b>F4P_</b>	SERIES F4 Process Controllers	285
<b>F4S_</b>	SERIES F4 Single Channel Ramping Controllers	279
<b>F4T_</b>	F4T With INTUITION®	215
<b>FM_</b>	Flex Module	217, 219, 220, 221
<b>HC_</b>	Exotic Metal Sheath Thermocouple, Plug or Jack Termination	76
<b>HD_</b>	ENVIROSEAL™ HD Sensor	106
<b>HF_</b>	Exotic Metal Sheath Thermocouple, Metal Transitions	77
<b>J_ _ 304</b>	Fiberglass Braided Thermocouple and Extension Wire SERIES 304, Type J	153
<b>J_ _ 305</b>	Fiberglass Wrapped Thermocouple and Extension Wire SERIES 305, Type J	155
<b>J_ _ 314</b>	High-Temperature Fiberglass Twisted Thermocouple Wire SERIES 314, Type J	156
<b>J_ _ 321</b>	High-Temperature Braided Fiberglass Thermocouple Wire, SERIES 321, Type J	157
<b>J_ _ 502</b>	PVC Insulated Extension Wire SERIES 502, Type J	161
<b>J_ _ 505</b>	PVC Insulated "RIPCORDER" SERIES 505, Type J	162
<b>J_ _ 506</b>	Small Gauge FEP Insulated SERIES 506, Type J	163
<b>J_ _ 507</b>	FEP Insulated Thermocouple and Extension Wire SERIES 507, Type J	165
<b>J_ _ 508</b>	TFE Insulated SERIES 508, Type J	167
<b>J_ _ 509</b>	FEP Insulated and Shielded Thermocouple and Extension Wire SERIES 509, Type J	169

# Part Number Index

Part Number	Description	Page Number
J__510	PVC Insulated and Shielded Thermocouple and Extension Wire SERIES 510, Type J	171
J__511	Polyimide Insulated and Twisted SERIES 511, Type J	173
J__512	Polyimide Insulated SERIES 512, Type J	175
J__516	PFA Insulated Thermocouple and Extension Wire SERIES 516, Type J	177
K__301	High Temperature Vitreous Silica Braided Thermocouple Wire SERIES 301, Type K	151
K__304	Fiberglass Braided Thermocouple and Extension Wire SERIES 304, Type K	153
K__305	Fiberglass Wrapped Thermocouple and Extension Wire SERIES 305, Type K	155
K__314	High-Temperature Fiberglass Twisted Thermocouple Wire SERIES 314, Type K	156
K__321	High-Temperature Braided Fiberglass Thermocouple Wire, SERIES 321, Type K	157
K__350	High-Temperature Ceramic Fiber Thermocouple Wire SERIES 350, Type K	159
K__355	High-Temperature Ceramic Fiber Thermocouple Wire SERIES 355, Type K	159
K__365	High Temperature Vitreous Silica Braided Thermocouple Wire SERIES 365, Type K	151
K__502	PVC Insulated Extension Wire SERIES 502, Type K	161
K__505	PVC Insulated "RIPCORDER" SERIES 505, Type K	162
K__506	Small Gauge FEP Insulated SERIES 506, Type K	163
K__507	FEP Insulated Thermocouple and Extension Wire SERIES 507, Type K	165
K__508	TFE Insulated SERIES 508, Type K	167
K__509	FEP Insulated and Shielded Thermocouple and Extension Wire SERIES 509, Type K	169
K__510	PVC Insulated and Shielded Thermocouple and Extension Wire SERIES 510, Type K	171
K__511	Polyimide Insulated and Twisted SERIES 511, Type K	173
K__512	Polyimide Insulated SERIES 512, Type K	175
K__516	PFA Insulated Thermocouple and Extension Wire SERIES 516, Type K	177
LF_	SERIES LF Limit Controllers	319
LS_	SERIES LS Safety Limit Controllers	321
LV_	SERIES LV Limit Controllers	316
M_	Melt Bolt Thermocouples	51
MC	Miniature Thermocouple Connector System	129
MCC_	MICROCOIL™ Thermocouple, Copper Tip	79
MCF_	Miniature Thermocouple Connector, Female	129
MCM_	Miniature Thermocouple Connector, Male	129
MCN_	MICROCOIL Thermocouple, Aluminum Nitride	79
MHX_	Crimp/Braze Adapter	129
OK_	Polyimide Bracket Style Thermocouples	50
PC_	POWER SERIES Power Switching Devices	347
PCN_	Pipe Thermowells, ½ in.	120
PDN_	Pipe Thermowells, ¾ in.	120
PEN_	Pipe Thermowells, 1 in.	120
PM	EZ-ZONE PM Controllers	256
PM__-AAAAB	EZ-ZONE PM Express Controllers	261, 313
PM3_	EZ-ZONE PM ½ DIN Controllers	254
PM4_	EZ-ZONE PM ¼ DIN Controllers	254
PM6_	EZ-ZONE PM ⅙ DIN Controllers	254
PM8_	EZ-ZONE PM ⅛ DIN Vertical Controllers	254
PM9_	EZ-ZONE PM ⅛ DIN Horizontal Controllers	254
PT_	PT Polypropylene Head and Connector Blocks	133
Q_	QPAC Switching Devices	352

# Part Number Index

Part Number	Description	Page Number
<b>RB_</b>	Standard Industrial Insulated Leads RTDs	92
<b>RC_</b>	Plug or Jack Termination RTDs	93
<b>RF_</b>	Metal Transitions RTDs	94
<b>RMA_</b>	EZ-ZONE RM Access Modules	238
<b>RMC_</b>	EZ-ZONE RM Control Modules	228
<b>RME_</b>	EZ-ZONE RM Expansion Modules	234
<b>RMH_</b>	EZ-ZONE RM High-Density Control Modules	230
<b>RML_</b>	EZ-ZONE RM High-Density Limit Modules	232
<b>RMS_</b>	EZ-ZONE High-Density Scanner Modules	236
<b>RR_</b>	Head Connection/Optional Transmitter RTDs	95
<b>RT_</b>	For Use with Thermowells RTDs	96
<b>RT_ _ _ 701</b>	RTD Lead Wire SERIES 701, PVC	180
<b>RT_ _ _ 704</b>	RTD Lead Wire SERIES 704, FEP	180
<b>RT_ _ _ 705</b>	RTD Lead Wire SERIES 705 Fiberglass	180
<b>RT_ _ _ 707</b>	RTD Lead Wire SERIES 707, PFA	180
<b>RT2_</b>	RTD Lead Wire, Type 2	180
<b>RT3_</b>	RTD Lead Wire, Type 3	180
<b>RT-30_</b>	PT Polypropylene Head and Connector Blocks	133
<b>RT4_</b>	RTD Lead Wire, Type 4	180
<b>S_</b>	Specialty RTD or Thermistors	98, 105
<b>S_ _ 304</b>	Fiberglass Braided Thermocouple and Extension Wire SERIES 304, Type S	153
<b>S_ _ 305</b>	Fiberglass Wrapped Thermocouple and Extension Wire SERIES 305, Type S	155
<b>S_ _ 502</b>	PVC Insulated Extension Wire SERIES 502, Type S	161
<b>S_ _ 506</b>	Small Gauge FEP Insulated SERIES 506, Type S	163
<b>S_ _ 507</b>	FEP Insulated Thermocouple and Extension Wire SERIES 507, Type S	165
<b>S_ _ 508</b>	TFE Insulated SERIES 508, Type S	167
<b>S_ _ 509</b>	FEP Insulated and Shielded Thermocouple and Extension Wire SERIES 509, Type S	169
<b>S_ _ 510</b>	PVC Insulated and Shielded Thermocouple and Extension Wire SERIES 510, Type S	171
<b>S_ _ 516</b>	PFA Insulated Thermocouple and Extension Wire SERIES 516, Type S	177
<b>SAB_</b>	Crimp/Brass Style Connectors	126
<b>SAC_</b>	Cable Clamp Style Connectors	126
<b>SC_</b>	S SERIES Connectors	126
<b>SK_</b>	Quick-Attach Thermocouple Connectors	127
<b>SKP_</b>	Single Panel Mount Hardware Connectors	131
<b>SSR_</b>	Solid State Relay Power Switching Devices	360
<b>ST_</b>	EZ-ZONE ST Controllers	247
<b>SV(U or N)_</b>	SpecView HMI Software Upgrade	388
<b>SVM_</b>	SpecView Mini HMI Software	387
<b>SVS_</b>	SpecView Standard HMI Software Standard	387
<b>T_ _ 304</b>	Fiberglass Braided Thermocouple and Extension Wire SERIES 304, Type T	153
<b>T_ _ 305</b>	Fiberglass Wrapped Thermocouple and Extension Wire SERIES 305, Type T	155
<b>T_ _ 502</b>	PVC Insulated Extension Wire SERIES 502, Type T	161
<b>T_ _ 505</b>	PVC Insulated "RIPCORDER" SERIES 505, Type T	162
<b>T_ _ 506</b>	Small Gauge FEP Insulated SERIES 506, Type T	163
<b>T_ _ 507</b>	FEP Insulated Thermocouple and Extension Wire SERIES 507, Type T	165

# Part Number Index

Part Number	Description	Page Number
<b>T__508</b>	TFE Insulated SERIES 508, Type T	167
<b>T__509</b>	FEP Insulated and Shielded Thermocouple and Extension Wire SERIES 509, Type T	169
<b>T__510</b>	PVC Insulated and Shielded Thermocouple and Extension Wire SERIES 510, Type T	171
<b>T__511</b>	Polyimide Insulated and Twisted SERIES 511, Type T	173
<b>T__512</b>	Polyimide Insulated SERIES 512, Type T	175
<b>T__516</b>	PFA Insulated Thermocouple and Extension Wire SERIES 516, Type T	177
<b>TB_</b>	Standard Industrial Thermistors	103
<b>TBD_</b>	Bimetallic Thermometer Wells-Threaded Thermowells	118
<b>TH-185_</b>	Brass Compression Fitting, Non-Adjustable	111
<b>TH-2745_</b>	Stainless Steel Compression Fitting, Non-Adjustable	111
<b>TH-2747_</b>	Stainless Steel Adjustable Compression Fitting, 1¼ in.	112
<b>TH-2748_</b>	Stainless Steel Adjustable Compression Fitting, 2 <sup>7</sup> / <sub>16</sub> in.	112
<b>TH-2760_</b>	Fixed Bayonet Fittings	113
<b>TH-2762_</b>	Adjustable Bayonet Compression Fittings	113
<b>TH-279_</b>	Stainless Steel Adjustable Compression Fitting Replacement Sealant Gland, 1¼ in.	112
<b>TH-280_</b>	Stainless Steel Adjustable Compression Fitting, Replacement Sealant Gland 2 <sup>7</sup> / <sub>16</sub> in.	112
<b>TH-295_</b>	Bayonet Adapter Fitting, ½ NPT Thread	113
<b>TH-298_</b>	Bayonet Adapter Fitting, ¾-24 SAE Thread	113
<b>TH-3_</b>	Three-Pole Connectors	128
<b>TR_</b>	Radio Frequency Thermocouples	81
<b>TS_</b>	Silver Series EM	382
<b>TST_</b>	TRUE SURFACE Thermocouples	83
<b>TST_</b>	Socket Weld Thermowells	119
<b>TT_</b>	Threaded Type Thermowells	117
<b>XP_</b>	Explosion Proof Thermocouple Connection Heads	133
<b>Z100-0815-_</b>	Solid State Relays — Heat Sinks	362

# Product Category Index

Product Category	Page Number
Accessories - Controllers	407
Accessories - Sensors	109
Arc Suppression	416
Base Metal Thermocouples	67
Basic and Limit Controllers	288, 291, 314, 317, 320
Connection Heads and Blocks	132
Connectors	125
Control Panels	421
Current Transformers	415
Data Loggers	381
DIN-A-MITE® A	328
DIN-A-MITE B	331
DIN-A-MITE C	334
DIN-A-MITE D	340
EHG® Controllers	266
EHG SL10 Controllers	262
EHG SL10 Software	401
EMI Filters	416
ENVIROSEAL™ HD Sensor	106
E-SAFE® II Power Switching Devices	353
EXACTSENSE® Thermocouple	64
Exotic Metal Sheath Thermocouple	74
Extension Wire	143
EZwarePlus Software	403
EZ-ZONE® Configurator	397
EZ-ZONE GSD Editor	400
EZ-ZONE LabVIEW™ Driver	399
EZ-ZONE PM Controllers	249
EZ-ZONE PM Express Controllers	258
EZ-ZONE PM Express Limit	310
EZ-ZONE PM Integrated PID Controllers	249
EZ-ZONE PM Limit	304
EZ-ZONE PM PID Controllers	249
EZ-ZONE RM Controllers	222
EZ-ZONE RM Access Modules	237
EZ-ZONE RM Control Modules	226
EZ-ZONE RM Expansion Modules	233
EZ-ZONE RM High-Density Control Modules	229
EZ-ZONE RM High-Density Limit Modules	231
EZ-ZONE RM High-Density Scanner Modules	235
EZ-ZONE RUI and Gateway	371
EZ-ZONE ST Controllers	242
Fittings	54, 89, 101

Product Category	Page Number
Fuses and Fuse Holders	406
General Applications Tube and Wire	32
High Temperature Thermocouples	71
Indicators	375
Integrated Multi-Function Controllers	209
Limits	297
MICROCOIL™ Thermocouples	78
Mineral Insulated (MI) Thermocouples	52
Mineral Insulated Cable	181
Multipoint Thermocouples	84
Noble Metal Thermocouples	72
Operator Interface Terminals	363
Panel Mount Adapter Plates	416
Power Controllers	325
POWER SERIES™ Power Switching Devices	343
Power Supplies	417
Power Switching Devices	325
Protection Tubes	121
QPAC Power Switching Devices	348
Radio Frequency Thermocouples	80
Remote User Interface (RUI)	371
Resistance Temperature Sensors	87
RTDs	88
RTD Lead Wire	178
RUIs	371
S SERIES Connectors	126
Scanners	297
Serial Converters	410
SERIES 5750 Transmitters	134
SERIES 5900 Transmitters	137
SERIES CF Controllers	291
SERIES CV Controllers	288
SERIES CZR Power Switching Devices	356
SERIES EHG Controllers	266
SERIES EHG SL10 Controllers	262
SERIES EHG SL10 Software	401
SERIES F4 Process Controllers	281
SERIES F4 Ramping Controllers	275
SERIES LF Limits	317
SERIES LS Safety Limits	320
SERIES LV Limits	314
SERV-RITE Wire	141
Silver Series EM	365
Software	393
Solid State Relays (SSR)	359

# Product Category Index

Product Category	Page Number
SpecView HMI Software	385
Temperature and Process Controllers	269
Thermistors	99
Thermocouples	23
Thermocouple and Extension Wire	143
Thermowells	115
Transmitters	134
TRUE SURFACE Thermocouple (TST)	82
XACTPAK® Cable	183

# Terms and Conditions of Sale

## Quantity and Weights:

Products purchased and sold hereunder shall be those for which buyer submits an order which is accepted by Watlow®. Watlow's quantities shall govern unless proved to be in error. On orders for products carried in stock, Watlow will deliver the ordered quantity specified. However, in the manufacture of products it is agreed that Watlow will be allowed production losses. Watlow shall have the right to manufacture, deliver and invoice for partial deliveries of products as stated below:

Quantity Ordered	Delivery Variation
1-4	No variation
5-24	± 1 unit
25-74	± 2 units
75-99	± 3 units
100+	± 3 percent
SERV-RITE® Insulated Wire and Cable	± 10 percent
XACTPAK® Sheathed Wire	± 10 percent

**Note: Watlow will deliver exact quantities on products with a net price of \$100.00 or more. If buyer expressly requests no variation in delivered quantity of products with a total net price under \$100.00, a ten percent (10%) surcharge will be added to the net billing on the invoice for such order.**

## Delivery:

FCA (Incoterms® 2010) - Watlow's Pickup Plant. Risk of loss and title transfer pass to buyer on delivery at the FCA point. Watlow shall prepay freight, assure the shipment and select the means of transportation unless buyer provides specific written instructions otherwise with buyer's order. Watlow shall not be bound to tender delivery of any quantities for which buyer has not given shipping instructions. Watlow shall be entitled to designate from time to time the locations from which buyer may receive or pick up products.

## Payment Terms:

Terms are net 30 days from date of invoice with approved credit. Prices and discounts are subject to change without notice. All quotations are valid for 30 days unless otherwise stated.

## Restocking Charges:

Stock heaters, controllers, sensors and accessories which have not been used or modified may be returned to the relevant Watlow plant for a twenty percent (20%) restocking charge. For Watlow's Hannibal plant products only, modified-stock products may be returned if not permanently modified, for a minimum thirty percent (30%) restocking charge. All stock and modified-stock products require Watlow's prior authorization to be returned and must be returned within one hundred twenty (120) days from the date of delivery. Controllers may not be returned if the packaging seal is broken. Non-stock (custom) heaters, controls, sensors and accessories are not returnable.

## Price Revision:

Prices are subject to change without advance notice. If Watlow desires to revise the discounts, prices, points of delivery, service allowances or terms of payment but is restricted to any extent against so doing by reason of any governmental request, law, regulation, order or action, or if the discounts, prices, points of delivery, service allowances or terms of payment then in effect are altered by reason of governmental request, law, regulation, order or action, Watlow shall have the right (i) to terminate this order by notice to buyer, (ii) to suspend deliveries for the duration of such restriction or alteration or (iii) to have applied to this order (as of the effective date of such restriction or alteration) any discounts,

prices, points of delivery, service allowances or terms of payment governmentally acceptable. Any delivery suspended under this section may be canceled without liability.

## Return Policy:

Prior approval must be obtained from the relevant Watlow plant to return any product. Watlow will assign a return authorization number and record the reason for the return. Watlow will examine returned product to determine the actual cause, if any, leading to buyer's return. If product has a manufacturing defect, Watlow, in its sole discretion, may issue a credit for the returned product or repair or replace with like product. If returned product is not subject to Watlow's warranty, buyer will be notified of the estimated cost of repair, if possible. Thereafter, buyer must advise Watlow whether or not buyer chooses to have product repaired at buyer's expense.

## Order Changes:

Buyer must notify Watlow in writing of requested changes in the quantity, drawings, designs or specifications for products which are ordered but not yet in the process of manufacture. After receipt of such notice, Watlow will inform buyer of any adjustments to be made in price, delivery schedules, etc. resulting from buyer's requested changes prior to incorporating requested changes into manufactured products. Controller products require written notice of requested changes not less than sixty (60) days prior to last scheduled shipping date.

## Freight and Taxes:

Prices do not include prepaid freight, federal, state or local taxes. Any increase in freight rates paid by Watlow on deliveries covered by this order and hereafter becoming effective and any tax or governmental charge or increase in same (excluding any franchise or income tax or other tax or charge based on income) (i) increasing the cost to Watlow of producing, selling or delivering products or of procuring products used therein or, (ii) payable by Watlow because of the production, sale or delivery of products, such as Sales Tax, Use Tax, Retailer's Occupational Tax, Gross Receipts Tax, Value Added Tax (VAT), and Ways Fees may, at Watlow's option, be added to the prices herein specified and be added to invoices.

## Engineering Charge:

On complex products, systems or controller software modifications, an engineering charge shall be applied or included in the price of prototypes. This charge is not subject to discounts.

## Tooling:

All tooling and fixtures are the property of Watlow. Watlow will accept buyer's special tooling if sent freight prepaid. Watlow will maintain this tooling, exercising reasonable care, in order to produce buyer's products. Permanent molds for aluminum cast-in and polymer products shall be the property and responsibility of buyer.

## Cancellation Charges:

There will be no cancellation charge for non-modified stock products. Non-stock and modified-stock products may be subject to a cancellation charge to be determined by Watlow depending upon the portion of product completed at the time of such cancellation.

## Excuse of Performance:

(A) Deliveries may be suspended by either party in the event of: Act of God, war, riot, fire, explosion, accident, flood, sabotage; lack of adequate fuel, power, raw materials, labor, containers or transportation facilities; compliance with governmental

# Terms and Conditions of Sale

requirements (as hereinafter defined); breakage or failure of machinery or apparatus; national defense requirements or any other event, whether or not of the class or kind enumerated herein, beyond the reasonable control of such party; or in the event of labor trouble, strike, lockout or injunction (provided that neither party shall be required to settle a labor dispute against its own best judgment); which event makes impracticable the manufacture, transportation, sale, purchase, acceptance, use or resale of products or a material upon which the manufacture of products is dependent.

(B) If Watlow determines that its ability to supply the total demand for products, or obtain any or a sufficient quantity of any material used directly or indirectly in the manufacture of products, is hindered, limited or made impracticable, Watlow may allocate its available supply of products or such material (without obligation to acquire other supplies of any such products or material) among itself and its purchasers on such basis as Watlow determines to be equitable without liability for any failure of performance which may result therefrom.

(C) Deliveries suspended or not made by reason of this Section shall be canceled without liability, but this agreement and/or order shall otherwise remain unaffected.

## Prototypes:

If buyer orders and/or Watlow delivers a product designated as a "prototype", no guarantees, warranties or representations as to fitness for a particular purpose or merchantability are made with respect to such prototype. Buyer shall have the duty and sole responsibility to test a prototype prior to acceptance and/or incorporation into end-use applications. Further, a production product based on a prototype design may differ in assembly methods and materials from the prototype. Buyer, therefore, shall have the duty and sole responsibility for testing and acceptance of production products which are based on prototype designs.

## Warranty and Limitation of Liability:

Watlow warrants its products against defects in material and workmanship for at least one (1) year (three (3) years on some controls) from the date of delivery, provided such product is properly applied, used and maintained. Refer to the express written warranty time period for each individual product or contact the relevant Watlow plant for such warranty time period information. Watlow does not warrant any product against damage from corrosion, contamination, misapplication, improper specification or wear and tear and operational conditions beyond Watlow's control. The terms of this warranty are the exclusive terms available to buyer and to any other person or entity to whom products are transferred during the period of this warranty. No person has authority to bind Watlow to a representation or warranty other than this express warranty. Watlow shall not be liable for incidental or consequential damages resulting from the use of products whether a claim for such damages is based upon warranty, contract, negligence or other cause of action. Should any product fail while subject to this warranty, such product shall be repaired or a substitute product shall be provided, at Watlow's option, at no charge to buyer or to any other person or entity to whom product is transferred during the period of this warranty. Watlow must be notified of the alleged failure of product within thirty (30) days of such event and advanced authorization for repair or replacement must be obtained in writing from Watlow. **THIS WARRANTY IS MADE EXPRESSLY IN LIEU OF ALL OTHER WARRANTIES, EXPRESS OR IMPLIED, INCLUDING WITHOUT LIMITATION, ANY**

**WARRANTY ARISING FROM A COURSE OF DEALING OR USAGE OF TRADE, AND ALL OTHER SUCH WARRANTIES ARE SPECIFICALLY EXCLUDED. THE CORRECTION OF ANY DEFECT IN OR FAILURE OF PRODUCTS BY REPAIR OR REPLACEMENT TO THE EXTENT SET FORTH ABOVE, SHALL BE WATLOW'S LIMIT OF LIABILITY AND THE EXCLUSIVE REMEDY FOR ANY AND ALL LOSSES, DELAYS OR DAMAGES RESULTING FROM THE PURCHASE OR USE OF THE PRODUCTS. IN NO EVENT SHALL WATLOW BE LIABLE FOR SPECIAL, INDIRECT, INCIDENTAL OR CONSEQUENTIAL DAMAGES. WATLOW SHALL NOT BE LIABLE FOR, AND BUYER AND ANY OTHER PERSON OR ENTITY TO WHOM PRODUCTS ARE TRANSFERRED DURING THE PERIOD OF THIS WARRANTY ASSUMES RESPONSIBILITY FOR, ALL PERSONAL INJURY AND PROPERTY DAMAGE RESULTING FROM OR RELATED TO THE HANDLING, POSSESSION OR USE OF PRODUCTS AND PRODUCTS MANUFACTURED AND SOLD BY WATLOW HEREUNDER.**

## Miscellaneous:

THE VALIDITY, INTERPRETATION AND PERFORMANCE OF THIS AGREEMENT AND/OR ORDER AND ANY DISPUTE CONNECTED HEREWITH SHALL BE GOVERNED AND CONSTRUED IN ACCORDANCE WITH THE LAWS OF THE STATE OF MISSOURI. These Terms and Conditions constitute the full understanding of the parties, a complete allocation of risks between them and a complete and exclusive statement of the terms and conditions of their agreement and/or order relating to the subject matter herein. Except as otherwise expressly provided herein, no conditions, usage of trade, course of dealing or performance, understanding or agreement and/or order purporting to modify, vary, explain or supplement the terms or conditions of this agreement and/or order shall be binding unless hereafter made in writing and signed by the party to be bound, and no modification shall be effected by the acknowledgment or acceptance of any purchase order or shipping instruction forms containing terms or conditions at variance with or in addition to those set forth herein. No waiver by either party with respect to any breach or default or of any right or remedy and no course of dealing or performance shall be deemed to constitute a continuing waiver of any other breach or default or of any other right or remedy, unless such waiver be expressed in writing signed by the party to be bound. If any term, condition or provision of this agreement and/or order or the application thereof is judicially or otherwise determined to be invalid or unenforceable, or if the parties mutually agree in writing to any revision of this agreement and/or order, the remainder of this agreement and/or order and the application thereof shall not be affected, and this agreement and/or order shall otherwise remain in full force and effect.

Rev. 11/07/11